

ACTIVE

Operating Instructions
Frequency inverter 230 V / 400 V
0.55 kW ... 132 kW



TABLE OF CONTENTS

1	General Information about the Documentation	9
1.1	Instruction manuals	9
1.2	This document	10
1.3	Warranty and liability	11
1.4	Obligation	12
1.5	Copyright	12
1.6	Storage	12
1.7	Final decommissioning	12
2	General safety instructions and information on use	13
2.1	Terminology	13
2.2	Designated use	13
2.3	Misuse	14
2.4	Residual risks	14
2.5	Safety and warning signs on frequency inverter	15
2.6	Warning information and symbols used in the Operating Instructions	15
2.6.1	Hazard classes	15
2.6.2	Hazard symbols	15
2.6.3	Prohibition signs	16
2.6.4	Personal safety equipment	16
2.6.5	Recycling	16
2.6.6	Grounding symbol	16
2.6.7	ESD symbol	16
2.6.8	Information signs	16
2.6.9	Font style in documentation	16
2.7	Directives and guidelines to be adhered to by the operator	17
2.8	Operator's general plant documentation	17
2.9	Operator's/operating staff's responsibilities	17
2.9.1	Selection and qualification of staff	17
2.9.2	General work safety	17
2.9.3	Ear protectors	17
2.10	Organizational measures	18
2.10.1	General	18
2.10.2	Use in combination with third-party products	18
2.10.3	Handling and installation	18
2.10.4	Electrical connections	18
2.10.5	Safe operation	19
2.10.6	Maintenance and service/troubleshooting	20
2.10.7	Final decommissioning	20
3	Storage and transport	21
3.1	Storage	21
3.2	Special safety instructions on transport of heavy frequency inverters	21
3.3	Dimensions/weight	22
3.4	Transfer to place of installation	22
3.5	Unpacking the device	22
3.6	Bringing the device into installation position	22
3.6.1	Sizes 1 through 6	22
3.6.2	Size 7	22

4	Scope of supply	23
4.1	Sizes 1 and 2: ACT 210 (up to 3.0 kW) and 410 (up to 4.0 kW)	23
4.2	Sizes 3 and 4: ACT 210 (4.0 to 9.2 kW) and 410 (5.5 to 15.0 kW)	24
4.3	Size 5 ACT410 (18.5 to 30.0 kW)	24
4.4	Size 6 ACT410 (37.0 to 65.0 kW)	25
4.5	Size 7 ACT410 (75.0 to 160.0 kW)	26
5	Technical Data	27
5.1	General technical data.....	27
5.2	Technical data of control electronics	29
5.3	ACT210 (0.55 up to 3.0 kW, 230 V).....	30
5.4	ACT210 (4.0 up to 9.2 kW, 230 V).....	32
5.5	ACT410 (0.55 up to 4.0 kW, 400 V).....	33
5.6	ACT410 (5.5 up to 15.0 kW, 400 V).....	34
5.7	ACT410 (18.5 up to 30.0 kW, 400 V).....	35
5.8	ACT410 (37.0 up to 65.0 kW, 400 V).....	36
5.9	ACT410 (75.0 up to 132.0 kW, 400 V).....	37
5.10	Operation Diagrams	38
6	Mechanical Installation	39
6.1	Air circulation	39
6.2	ACT210 (up to 3.0 kW) and ACT410 (up to 4.0 kW)	40
6.3	ACT210 (4.0 up to 9.2 kW) and ACT410 (5.5 up to 15.0 kW)	41
6.4	ACT410 (18.5 up to 30.0 kW).....	42
6.5	ACT410 (37.0 up to 65.0 kW).....	43
6.6	ACT410 (75.0 up to 132.0 kW).....	44
7	Electrical Installation	45
7.1	EMC Information	47
7.2	Block diagram.....	48
7.3	Optional Components	49
7.4	Connection of the device	50
7.4.1	Dimensioning of the conductor cross section	50
7.4.2	Mains Connection	51
7.4.3	Motor connection.....	52
7.4.4	Connection of a Brake Resistor	54
7.5	Connection of the construction sizes	55
7.5.1	ACT210 (up to 3.0 kW) and ACT410 (up to 4.0 kW)	55
7.5.2	ACT210 (4.0 up to 9.2 kW) and ACT410 (5.5 up to 15.0 kW)	57
7.5.3	ACT410 (18.5 up to 30.0 kW).....	59
7.5.4	ACT410 (37.0 up to 65.0 kW).....	61
7.5.5	ACT410 (75.0 up to 132.0 kW).....	63
7.6	Control terminals.....	65
7.6.1	Relay Output.....	66
7.6.2	Control Terminals – Terminal Diagram	66
7.6.3	Installation notes according to UL508c.....	71
8	Control Unit KP500.....	72
8.1	Menu Structure.....	73
8.2	Main Menu	73
8.3	Actual Value Menu (VAL).....	74

8.4	Parameter Menu (PARA)	75
8.5	Copy Menu (CPY)	76
8.5.1	Reading the Stored Information	76
8.5.2	Menu Structure	77
8.5.3	Selecting the Source	77
8.5.4	Selecting the Destination	78
8.5.5	Copy Operation	78
8.5.6	Error Messages.....	79
8.6	Read data from the KP 500 control unit	80
8.6.1	Activating.....	80
8.6.2	Transfer data	81
8.6.3	Reset to Normal Mode	81
8.7	Control Menu (CTRL)	82
8.8	Controlling the Motor via the Control Unit	82
9	Commissioning the Frequency Inverter	85
9.1	Switching on Mains Voltage	85
9.2	Setup Using the Control Unit	85
9.2.1	Configuration	86
9.2.2	Data Set	88
9.2.3	Motor Type	88
9.2.4	Machine Data	89
9.2.5	Plausibility check	89
9.2.6	Parameter identification	90
9.2.7	Application data	92
9.2.8	Quitting commissioning.....	93
9.3	Check direction of rotation	93
9.4	Speed sensor	94
9.4.1	Speed sensor 1	95
9.4.2	Speed sensor 2	95
9.5	Set-up via the Communication Interface	96
10	Inverter Data	98
10.1	Serial Number	98
10.2	Optional Modules	98
10.3	Inverter Software Version	98
10.4	Set Password	98
10.5	Control Level	98
10.6	User Name	99
10.7	Configuration	99
10.8	Language	101
10.9	Programming	101
11	Machine Data	102
11.1	Rated Motor Parameters	102
11.2	Further motor parameters	102
11.2.1	Stator Resistance.....	103
11.2.2	Leakage Coefficient	103
11.2.3	Magnetizing Current	103
11.2.4	Rated Slip Correction Factor	104
11.3	Internal values	104
11.4	Speed sensor 1	105
11.4.1	Operation mode speed sensor 1	105

11.4.2	Division marks, speed sensor 1	106
12	System Data	107
12.1	Actual Value System	107
12.2	Volume Flow and Pressure	107
13	Operational Behavior	108
13.1	Starting Behavior	108
13.1.1	Starting Behavior of Sensorless Control System	108
13.1.2	Flux Formation	110
13.2	Stopping Behavior	111
13.2.1	Switch-Off Threshold	113
13.2.2	Holding Time.....	113
13.3	Direct current brake	113
13.4	Auto Start	114
13.5	Search Run	115
13.6	Positioning.....	116
13.6.1	Reference Positioning	117
13.6.2	Axle Positioning	120
14	Error and warning behavior	122
14.1	Overload Ixt	122
14.2	Temperature.....	122
14.3	Controller Status	122
14.4	IDC Compensation Limit	123
14.5	Frequency Switch-Off Limit.....	123
14.6	Motor Temperature	123
14.7	Phase Failure	124
14.8	Automatic Error Acknowledgment	124
15	Reference Values.....	126
15.1	Frequency Limits	126
15.2	Slip Frequency	126
15.3	Percentage Value Limits.....	126
15.4	Frequency Reference Channel.....	127
15.4.1	Block Diagram	128
15.5	Reference Percentage Channel	130
15.5.1	Block Diagram	130
15.6	Fixed Reference Values	132
15.6.1	Fixed Frequencies.....	132
15.6.2	JOG-Frequency.....	132
15.6.3	Fixed Percentages	133
15.7	Frequency ramps	133
15.8	Percentage Value Ramps.....	136
15.9	Block Frequencies.....	136
15.10	Motor Potentiometer	137
15.10.1	Motorpoti (MP)	138
15.10.2	Motorpoti (KP).....	138
15.10.3	Controlling the Motor via the Control Unit	139
15.11	Repetition frequency input.....	139
16	Control Inputs and Outputs	141

16.1	Multi-function input MFI1	141
16.1.1	Analog Input MFI1A.....	141
16.2	Multi-function output MFO1	145
16.2.1	Analog Output MFO1A	146
16.2.2	Frequency Output MFO1F	147
16.3	Digital Outputs	148
16.3.1	Setting Frequency	149
16.3.2	Reference value reached.....	149
16.3.3	Flux Formation Ended	149
16.3.4	Open brake	150
16.3.5	Current Limitation.....	150
16.3.6	External Fan.....	150
16.3.7	Warning Mask	150
16.4	Digital Inputs	153
16.4.1	Start command.....	155
16.4.2	3-Wire-Control.....	156
16.4.3	Timer.....	156
16.4.4	Thermo-contact.....	157
16.4.5	n-/M-Control Change-Over	157
16.4.6	Data Set Change-Over	157
16.4.7	Fixed Value Change-Over	158
16.4.8	Motor Potentiometer	158
16.5	Function Modules	159
16.5.1	Timer.....	159
16.5.2	Comparator.....	161
16.5.3	Logic Modules	162
17	V/f - Characteristic.....	166
18	Control Functions	168
18.1	Intelligent current limits	168
18.2	Voltage controller	169
18.3	Technology Controller	173
18.4	Functions of Sensorless Control	181
18.4.1	Slip compensation	181
18.4.2	Current limit value controller	182
18.5	Functions of Field-Orientated Control	183
18.5.1	Current Controller.....	183
18.5.2	Torque Controller	184
18.5.3	Speed controller	185
18.5.4	Acceleration Pre-Control.....	188
18.5.5	Field Controller.....	188
18.5.6	Modulation Controller.....	189
19	Special Functions	191
19.1	Pulse Width Modulation	191
19.2	Fan	192
19.3	Bus controller	192
19.4	Brake Chopper and Brake Resistance	193
19.4.1	Dimensioning of Brake Resistor	194
19.5	Motor Circuit Breaker	195
19.6	V-belt Monitoring	197
19.7	Functions of Field-Orientated Control	198
19.7.1	Motor Chopper	198

19.7.2	Temperature Adjustment	198
19.7.3	Encoder Monitoring.....	199
19.8	Start Monitoring	201
20	Actual Values.....	202
20.1	Actual Values of the Frequency Inverter.....	202
20.2	Actual Values of the Machine	203
20.3	Actual Value Memory.....	204
20.4	Actual Values of the System	205
20.4.1	Actual Value System	205
20.4.2	Volume Flow and Pressure	205
21	Error Protocol	206
21.1	Error List.....	206
21.1.1	Error Messages.....	206
21.2	Error Environment	208
22	Operational and Error Diagnosis	210
22.1	Status Display.....	210
22.2	Status of Digital Signals	210
22.3	Controller Status	211
22.4	Warning Status.....	212
23	Parameter List.....	213
23.1	Actual Value Menu (VAL).....	213
23.2	Parameter Menu (PARA)	216

1 General Information about the Documentation

1.1 Instruction manuals

For better clarity, the documentation is structured according to the customer-specific requirements made on the frequency inverter.

Quick Start Guide

The "Quick Start Guide" describes the basic steps required for mechanical and electrical installation of the frequency inverter. The guided commissioning supports you in the selection of necessary parameters and the configuration of the frequency inverter by the software.

Operating Instructions

The Operating Instructions document the complete functionality of the frequency inverter. The parameters required for special purposes, for adjustment to the application and the numerous additional functions are described in detail.

Application manual

The application manual supplements the documentation for purposeful installation and commissioning of the frequency inverter. Information on various topics in connection with the use of the frequency inverter is described in context with the specific application.



If you need a copy of the documentation or additional information, contact your local representative of Bonfiglioli.

The following instructions are available for the *ACTIVE* series:

<i>ACTIVE</i> Operating Instructions	Function of frequency inverter.
Quick Start Guide <i>ACTIVE</i>	Installation and commissioning Supplied with the device.
Manuals	CM-CAN: CANopen manual
Communication interfaces	CM-PDP-V1: Profibus DP-V1 manual CM-232/CM-485: VABus manual (serial protocol) CM-232/CM-485 Modbus: Modus ASCII and RTU manual CM-VABus/TCP: Ethernet Module CM-VABus/TCP CM-ModbusTCP: Ethernet Module CM-Modbus/TCP CM-EtherCAT®: Ethernet Module CM-EtherCAT® CM-ProfiNet: Ethernet Module CM-ProfiNet CM-EtherNet-I/P: Ethernet Module CM-EtherNet-I/P (i.V.)
Manuals	EM-ABS-01: Absolute encoder module
Extension modules	EM-ENC-01: Speed sensor (encoder) module EM-ENC-02: Speed sensor (encoder) module EM-ENC-03: Speed sensor (encoder) module EM-ENC-04: Speed sensor (encoder) module EM-ENC-05: Speed sensor (encoder) module EM-IO-01: Extension module for digital inputs/outputs EM-IO-02: Extension module for digital inputs/outputs EM-IO-03: Extension module for digital inputs/outputs EM-IO-04: Extension module for digital inputs/outputs EM-RES-01: Resolver module EM-RES-02: Resolver module EM-RES-03: Resolver module EM-SYS: System Bus module
PLC application manual	Logic linking of digital signals. Functions for analog signals such as comparisons and mathematical functions. Graphical support for programming with function blocks.
Application manual "Positioning"	Positioning functions of Configurations x40.
Application manual "Electronic gear"	Linking of at least 2 drives as electronic gear with Slave drive in Configuration x15 or x16.
Application manual "Hoist unit drives"	Advanced brake control for hoist unit drives.



The products for CANopen® communication comply with the specifications of the user organization CiA® (CAN in Automation).



The products for EtherCAT® communication comply with the specifications of the user organization ETG (EtherCAT Technology Group).

The present documentation was prepared with great care and it was subjected to extensive and repeated reviews. For reasons of clarity, it was not possible to include all details of all types of the product in the documentation. Neither was it possible to consider all conceivable installation, operation or maintenance situations. If you require further information or if you meet with specific problems which are not dealt with in sufficient detail in the documentation, contact your local Bonfiglioli agent.

The present document was created in German. Other language versions are translations.

1.2 This document

This documentation describes the frequency inverters of the *ACTIVE* series. The modular hardware and software structure enables customer-specific adaptation of the frequency inverters. Applications with high functionality and dynamism requirements can be realized easily.

The Operating Instructions contain important information on the installation and the use of the product in its specified application range. Compliance with this user manual contributes to avoiding risks, minimizing repair cost and downtimes, and increasing the reliability and service life of the frequency inverter.

For this reason, make sure you read the Operating Instructions carefully.

IMPORTANT:

Compliance with the documentation is required to ensure safe operation of the frequency inverter. Bonfiglioli Vectron GmbH shall not be held liable for any damage caused by any non-compliance with the documentation.



In case any problems occur which are not covered by the documentation sufficiently, please contact the manufacturer.



For safe commissioning and operation of the ACT (ACTIVE) series, the following documentation must be complied with:

- This Operating Instructions Document

This documentation applies to the following frequency inverter series:

- ACTIVE 210
- ACTIVE 410

The ACTIVE series can be recognized by its label on the case and on the name plate.

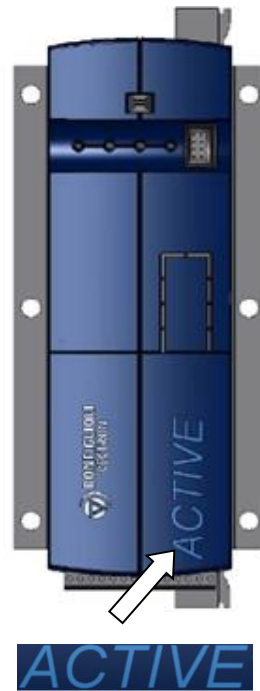

1.3 Warranty and liability

Bonfiglioli Vectron GmbH (hereinafter referred to as “manufacturer”) notes that the contents of this Operating Instructions document do not form part of any previous or existing agreement, assurance or legal relationship between the manufacturer and the user of these Operating Instructions (hereinafter referred to as the “User”). Neither are they intended to supplement or replace such agreements, assurances or legal relationships. Any obligations of the manufacturer shall solely be based on the relevant purchase agreement which also includes the complete and solely valid warranty stipulations. These contractual warranty provisions are neither extended nor limited by the specifications contained in this documentation.

The manufacturer reserves the right to correct or amend the specifications, product information and omissions in these operating instructions without prior notice. The manufacturer assumes no responsibility to update these Operating Instructions. The manufacturer shall not be liable for any damage, injuries or costs which may be caused by the aforementioned reasons.

In addition, the manufacturer excludes any warranty and disclaims all liability, including without limitation direct, indirect, special, punitive, incidental, exemplary or consequential damages arising out of or in connection with one or more of the following causes:

- inappropriate use of the frequency inverter,
- non-compliance with the instructions, warnings and prohibitions contained in the documentation,
- unauthorized modifications of the frequency inverter,
- insufficient monitoring of parts of the machine/plant which are subject to wear,
- repair work at the machine/plant not carried out properly or in time,
- catastrophes by external impact and Force Majeure.

1.4 Obligation

These Operating Instructions must be read before commissioning and complied with. Anybody entrusted with tasks in connection with the

- transport,
- assembly,
- installation of the frequency inverter and
- operation of the frequency inverter

must have read and understood the Operating Instructions and, in particular, the safety instructions in order to prevent personal and material losses.

1.5 Copyright

In accordance with applicable law any copyrights relating to this document shall remain with

Bonfiglioli Vectron GmbH
Europark Fichtenhain B6
47807 Krefeld
Germany

This document is intended for the operator of the frequency inverter. Any disclosure or copying of this document, exploitation and communication of its contents (as hardcopy or electronically) shall be forbidden, unless permitted expressly.

Any non-compliance will constitute an offense against the copyright law, the law against unfair competition and the German Civil Code and may result in claims for damages. All rights relating to patent, utility model or design registration reserved.

1.6 Storage

The documentation forms an integral part of the frequency inverter. It must be stored such that it is accessible to operating staff at all times. If the frequency inverter is sold on to other users, then the documentation must also be handed over.

1.7 Final decommissioning

After the end of product service life, the user/operator must take the device out of operation.



For more information about the decommissioning of the device refer to the applicable operating instructions document.

Disposal requirements under European Union WEEE regulations

The product is marked with the WEEE symbol shown below.

This product cannot be disposed as general household waste. Users responsible for the final disposal must make sure that it is carried out in accordance with the European Directive 2012/19/EU, where required, as well as the relative national transposition rules. Fulfil disposal also in according with any other legislation in force in the country.



2 General safety instructions and information on use

This chapter contains general safety instructions for the Operator and the Operating Staff. At the beginning of certain main chapters, some safety instructions are included which apply to all work described in the relevant chapter. Special work-specific safety instructions are provided before each safety-relevant work step.

2.1 Terminology

According to the documentation, different activities must be performed by certain persons with certain qualifications.

The groups of persons with the required qualification are defined as follows:

Operator

This is the entrepreneur/company who/which operates the frequency inverter and uses it as per the specifications or has it operated by qualified and instructed staff.

Operating staff

The term Operating Staff covers persons instructed by the Operator of the frequency inverter and assigned the task of operating the frequency inverter.

Skilled Personnel

The term Skilled Personnel covers staff that are assigned special tasks by the Operator of the frequency inverter, e.g. installation, maintenance and service/repair and troubleshooting. Based on their qualification and/or know-how, Skilled Personnel must be capable of identifying defects and assessing functions.

Qualified electrician

The term Qualified Electrician covers qualified and trained staff who has special technical know-how and experience with electrical installations. In addition, Qualified Electricians must be familiar with the applicable standards and regulations, they must be able to assess the assigned tasks properly and identify and eliminate potential hazards.

Instructed person

The term Instructed Person covers staff who was instructed and trained about/in the assigned tasks and the potential hazards that might result from inappropriate behavior. In addition, instructed persons must have been instructed in the required protection provisions, protective measures, the applicable directives, accident prevention regulations as well as the operating conditions and verified their qualification.

Expert

The term Expert covers qualified and trained staff who has special technical know-how and experience relating to frequency inverter. Experts must be familiar with the applicable government work safety directives, accident prevention regulations, guidelines and generally accepted rules of technology in order to assess the operationally safe condition of the frequency inverter.

2.2 Designated use

The frequency inverter is designed according to the state of the art and recognized safety regulations.

The frequency inverters are electrical drive components intended for installation in industrial plants or machines. Commissioning and start of operation are not allowed until it has been verified that the machine meets the requirements of the EC Machinery Directive 2006/42/EC and DIN EN 60204-1.

The frequency inverters meet the requirements of the low voltage directive 2014/35/EU and DIN EN 61800-5-1. CE-labelling is based on these standards. Responsibility for compliance with the EMC Directive 2014/30/EU lies with the operator. Frequency inverters are only available at specialized dealers and are exclusively intended for commercial use as per EN 61000-3-2.

No capacitive loads may be connected to the frequency inverter.

The technical data, connection specifications and information on ambient conditions are indicated on the rating plate and in the documentation and must be complied with in any case.

2.3 Misuse

Any use other than that described in "Designated use" shall not be permissible and shall be considered as misuse.

For, example, the machine/plant must not be operated

- by uninstructed staff,
- while it is not in perfect condition,
- without protection enclosure (e.g., covers),
- without safety equipment or with safety equipment deactivated,
- when general requirements, such as operating conditions and technical data, are not met.

The manufacturer shall not be held liable for any damage resulting from such misuse. The sole risk shall be borne by the operator.

Explosion protection

The frequency inverter is an IP 20 ingress protection rating device. For this reason, use of the device in explosive atmospheres is not permitted.

2.4 Residual risks

Residual risks are special hazards involved in handling of the frequency inverter which cannot be eliminated despite the safety-compliant design of the device. Residual risks are not obviously identifiable and can be a potential source of injury or a health hazard.

Typical residual hazards include:

- Electrical hazard
- Danger of contact with energized components due to a defect, opened covers or enclosures or improper working on electrical equipment.
- Danger of contact with energized components in frequency inverter if no external disconnection device was installed by the operator.

During operation, all covers must be installed correctly, and all electrical cabinet doors must be closed to minimize electrical hazards.

When LEDs and other indicating elements on the frequency inverter go out, this does not necessarily mean that the device is deenergized. Before carrying out any Work at the device where contact with energized parts might be possible, it must be checked in any case, i.e., irrespective of the status of any indicating elements that may be installed, if the device is deenergized.

Charged capacitors in DC link

Sizes 1 through 7 (up to 160 kW): The DC-link may have dangerous voltage levels even up to 3 minutes after shutdown.

Electrostatic charging

Touching electronic components entails the risk of electrostatic discharges.

Thermal hazards

Risk of accidents by hot machine/plant surfaces, e.g. heat sink, transformer, fuse or sine filter.

Danger of equipment falling down/over, e.g. during transport

Center of gravity is not the middle of the electrical cabinet modules.

2.5 Safety and warning signs on frequency inverter

- Comply with all safety instructions and danger information provided on the frequency inverter.
- Safety information and warnings on the frequency inverter must not be removed.

2.6 Warning information and symbols used in the Operating Instructions

2.6.1 Hazard classes

The following hazard identifications and symbols are used to mark particularly important information:



DANGER

Identification of immediate threat holding a **high** risk of death or serious injury if not avoided.



WARNING

Identification of immediate threat holding a **medium** risk of death or serious injury if not avoided.



CAUTION

Identification of immediate threat holding a **low** risk of minor or moderate physical injury if not avoided.

NOTICE

Identification of a threat holding a risk of material damage if not avoided.



2.6.2 Hazard symbols

Symbol	Meaning	Symbol	Meaning
	General hazard		Suspended load
	Electrical voltage		Hot surfaces
	Danger of crushing		

2.6.3 Prohibition signs

Symbol	Meaning
	No switching; it is forbidden to switch the machine/plant, assembly on

2.6.4 Personal safety equipment

Symbol	Meaning
	Wear body protection
	Wear ear protectors

2.6.5 Recycling

Symbol	Meaning
	Recycling, to avoid waste, collect all materials for reuse

2.6.6 Grounding symbol

Symbol	Meaning
	Ground connection

2.6.7 ESD symbol

Symbol	Meaning
	ESD: Electrostatic Sensitive Devices, i.e. components and assemblies sensitive to electrostatic energy

2.6.8 Information signs

Symbol	Meaning
	Tips and information making using the frequency inverter easier.

2.6.9 Font style in documentation

Example	Font style	Use
1234	bold	Representation of parameter numbers
<i>Parameter</i>	inclined , font: Times New Roman	Representation of parameter names
P.1234	bold	Representation of parameter numbers without name, e.g. in formulas
Q.1234	bold	Representation of source numbers

2.7 Directives and guidelines to be adhered to by the operator

The operator must follow the following directives and regulations:

- Ensure that the applicable workplace-related accident prevention regulations as well as other applicable national regulation are accessible to the staff.
- An authorized person must ensure, before using the frequency inverter, that the device is used in compliance with its designated use and that all safety requirements are met.
- Additionally, comply with the applicable laws, regulations and directives of the country in which the frequency inverter is used.
- Any additional guidelines and directives that may be required additionally shall be defined by the operator of the machine/plant considering the operating environment.

2.8 Operator's general plant documentation

- In addition to the Operating Instructions, the operator should issue separate internal user manuals for the frequency inverter. The Operating Instructions of the frequency inverter must be included in the Operating Instructions of the whole plant.

2.9 Operator's/operating staff's responsibilities

2.9.1 Selection and qualification of staff

- Any work on the frequency inverter may only be carried out by skilled personnel. The staff must not be under the influence of any drugs. Note the minimum age required by law. Define the staff's responsibility pertaining to all work on the frequency inverter clearly.
- Work on the electrical components may only be performed by a qualified electrician according to the applicable rules of electrical engineering.
- The operating staff must be trained for the relevant work to be performed.

2.9.2 General work safety

- In addition to the Operating Instructions of the machine/plant, any applicable legal or other regulations relating to accident prevention and environmental protection must be complied with. The staff must be instructed accordingly. Such regulations and/or requirements may include, for example, handling of hazardous media and materials or provision/use of personal protective equipment.
- In addition to this Operating Instructions, issue any additional directives that may be required to meet specific operating requirements, including supervision and reporting requirements, e.g. directives relating to work organization, workflow and employed staff.
- Unless approved of expressly by the manufacturer, do not modify the frequency inverter in any way, including addition of attachments or retrofits.
- Only use the frequency inverter if the rated connection and setup values specified by the manufacturer are met.
- Provide appropriate tools as may be required for performing all work on the frequency inverter properly.

2.9.3 Ear protectors

- The frequency inverter produces noise. Due to noise development, frequency inverters should only be installed in normally unstaffed areas.
- Noise emission in operation is < 85 dB(A) in the case of sizes 1 through 7.
- Noise emission in operation is approx. 86 dB(A) in the case of size 8. Ear protectors must be used when staying near the frequency inverter.

2.10 Organizational measures

2.10.1 General

- Train your staff in the handling and use of the frequency inverter and the machine/plant as well as the risks involved.
- Use of any individual parts or components of the frequency inverter in other parts of the operator's machine/plant is prohibited.
- Optional components for the frequency inverter must be used in accordance with their designated use and in compliance with the relevant documentation.

2.10.2 Use in combination with third-party products

- Please note that Bonfiglioli Vectron GmbH will not accept any responsibility for compatibility with third-party products (e.g. motors, cables or filters).
- In order to enable optimum system compatibility Bonfiglioli Vectron GmbH offers components facilitating commissioning and providing optimum synchronization of the machine/plant parts in operation.
- If you use the frequency inverter in combination with third-party products, you do so at your own risk.

2.10.3 Handling and installation

- Do not commission any damaged or destroyed components.
- Prevent any mechanical overloading of the frequency inverter. Do not bend any components and never change the isolation distances.
- Do not touch any electronic construction elements and contacts. The frequency inverter is equipped with components which are sensitive to electrostatic energy and can be damaged if handled improperly. Any use of damaged or destroyed components will endanger the machine/plant safety and shall be considered as non-compliance with the applicable standards.
- Only install the frequency inverter in a suitable operating environment. The frequency inverter is exclusively designed for installation in industrial environments.
- If seals are removed from the case, this can result in the warranty becoming null and void.

2.10.4 Electrical connections

- The five safety rules must be complied with.
- Never touch live terminals. In sizes 1 through 7, the DC-link may have dangerous voltage levels up to 3 minutes after shutdown. In size 8, the DC-link may have dangerous voltage levels up to 10 minutes after shutdown.
- When performing any work on/with the frequency inverter, always comply with the applicable national and international regulations/laws on work on electrical equipment/plants of the country in which the frequency inverter is used.
- The cables connected to the frequency inverters may not be subjected to high-voltage insulation tests unless appropriate circuitry measures are taken before.
- Only connect the frequency inverter to suitable supply mains. The frequency inverter may be operated in TN, TT and IT grid types. Precautions must be taken for operation in IT grids, see chapter 7 "Electrical Installation". Operation in a corner-grounded TN grid shall not be permissible.

The five safety rules

When working on/in electrical plants, always follow the five safety rules:

- Disconnect
- Secure to prevent restarting
- check for absence of voltage,
- carry out earthing and short-circuiting
- cover or shield neighboring live parts

2.10.5 Safe operation

- During operation of the frequency inverter, always comply with the applicable national and international regulations/laws on work on electrical equipment/plants.
- Before commissioning and the start of the operation, make sure to fix all covers and check the terminals. Check the additional monitoring and protective devices according to the applicable national and international safety directives.
- During operation, all covers must be installed correctly, and all electrical cabinet doors must be closed. During operation, never open the machine/plant.
- No connection work shall be carried out while power supply is on.
- The machine/plant holds high voltage levels during operation, is equipped with rotating parts (fan) and has hot surfaces. Any unauthorized removal of covers, improper use, wrong installation or operation may result in serious injuries or material damage.
- Some components, e.g. the heat sink or braking resistor, may be hot even some time after the machine/plant was shut down. Don't touch any surfaces directly after shutdown. Wear safety gloves where necessary.
- The frequency inverter may hold dangerous voltage levels until the capacitor in the DC link is discharged. After shutdown, wait for at least 3 minutes (sizes 1 through 7) before starting any electrical or mechanical work on the frequency inverter. Even after this waiting time, make sure that the equipment is deenergized in accordance with the safety rules before starting the work.
- In order to avoid accidents or damage, only skilled personnel and electricians may carry out the work such as installation, commissioning or setup.
- In the case of a defect of terminals and/or cables, immediately disconnect the frequency inverter from mains supply.
- Persons not familiar with the operation of the frequency inverter and children must not have access to the device.
- Do not bypass nor decommission any protective devices.
- The frequency inverter may be connected to power supply every 60 s. This must be considered when operating a mains contactor in jog operation mode. For commissioning or after an emergency stop, a non-recurrent, direct restart is permissible.
- After a failure and restoration of the power supply, the motor may start unexpectedly if the AutoStart function is activated.
If staff are endangered, a restart of the motor must be prevented by means of external circuitry.
- Before commissioning and the start of the operation, make sure to fix all covers and check the terminals. Check the additional monitoring and protective devices according to EN 60204 and applicable the safety directives (e.g. Working Machines Act or Accident Prevention Directives).

2.10.6 Maintenance and service/troubleshooting

- Visually inspect the frequency inverter when carrying out the required maintenance work and inspections at the machine/plant.
- Perform the maintenance work and inspections prescribed for the machine carefully, including the specifications on parts/equipment replacement.
- Work on the electrical components may only be performed by a qualified electrician according to the applicable rules of electrical engineering. Only use original spare parts.
- Unauthorized opening and improper interventions in the machine/plant can lead to personal injury or material damage. Any repair work may only be carried out by the manufacturer or persons approved/licensed by the manufacturer. Any repair work must be carried out by qualified electricians. Check protective equipment regularly.
- Before performing any maintenance work, the machine/plant must be disconnected from mains supply and secured against restarting. The five safety rules must be complied with.

2.10.7 Final decommissioning

Unless separate return or disposal agreements were made, recycle the disassembled frequency inverter components:

- Scrap metal materials
- Recycle plastic elements
- Sort and dispose of other component materials



Electric scrap, electronic components, lubricants and other utility materials must be treated as special waste and may only be disposed of by specialized companies.



In any case, comply with any applicable national disposal regulations as regards environmentally compatible disposal of the frequency inverter. For more details, contact the competent local authorities.

3 Storage and transport

3.1 Storage

NOTICE

Damage caused by incorrect storage

- Wrong or inappropriate storage may result in damage, e.g. due to moisture and dirt. Avoid major temperature variations and high air humidity.
- During storage, protect the device against moisture and dirt.

- The frequency inverters must be stored in an appropriate way. During storage, the devices must remain in their original packaging.
- The units may only be stored in dry rooms which are protected against dust and moisture and are exposed to small temperature deviations only. The requirements of DIN EN 60721-3-1 for storage, DIN EN 60721-3-2 for transport and labeling on the packaging must be met.
- The duration of storage without connection to the permissible nominal voltage may not exceed one year. After one year of storage, connect the device to mains voltage for 60 minutes.

If the duration of storage without connection to the permissible nominal voltage does exceed one year, the inverter capacitors must be re-formed. Contact your Bonfiglioli representative.

3.2 Special safety instructions on transport of heavy frequency inverters

WARNING



High weight and unusual center of gravity!

Tilting the frequency inverter may result in death or serious injuries. Due to the size and weight of the frequency inverter, there is the risk of accidents during transport. Center of gravity is not the middle of the frequency inverter. The underside of the frequency inverter, due to its design, cannot support the frequency inverter.

- Take utmost care during transport in order to prevent damage and deformation. Transport, attachment and lifting of loads may only be carried out by specially instructed staff who are familiar with the work.
- Only use suitable transport and lifting equipment with sufficient carrying capacity. The lifting cables/chains used must be able to carry the weight of the frequency inverter. Check the ropes or chains for damage.
- Wear appropriate safety clothing.
- When lifting the frequency inverter up ensure that it does not fall over, is displaced, swings out or falls down.
- Before the frequency inverter is lifted up, everybody must have left the work area.
- Before transport, make sure the transport path has sufficient carrying capacity.
- Do not step under suspended loads.
- Do not put the frequency inverter down in upright position without providing a suitable supporting structure.

3.3 Dimensions/weight



For information on the weight and dimensions of the frequency inverter, refer to chapter 5 "Technical Data".

3.4 Transfer to place of installation

Transfer to the place of installation is done with the product in its original packaging. Frequency inverters as from size 7 must be transferred to the place of installation in horizontal position, rear-side down. A forklift truck or crane with crane fork can be used for transfer to the place of installation.

- Apply the fork in the middle of the transport unit.
- Secure the transport unit to prevent it from falling down and overturning.
- Lift the transport unit up carefully.
- At the place of installation, put the transport unit down on a level and bearing surface.

3.5 Unpacking the device

- Carefully remove packaging.
- Check if the delivered devices correspond to the order.
- Check the device for transport damage and completeness.
- Any defects/damage must be reported to the supplier immediately.



Ensure that all packaging materials are disposed of in an environmentally compatible manner.

3.6 Bringing the device into installation position

3.6.1 Sizes 1 through 6

- Depending on the weight, one or two persons are required for lifting the device into the installation position in the electrical cabinet. For information on installation, refer to chapter 6 "Mechanical Installation".

3.6.2 Size 7

- Fix two crane eyes (M8) in the marked threaded holes on the top side of the device.
- Use appropriate lifting means.

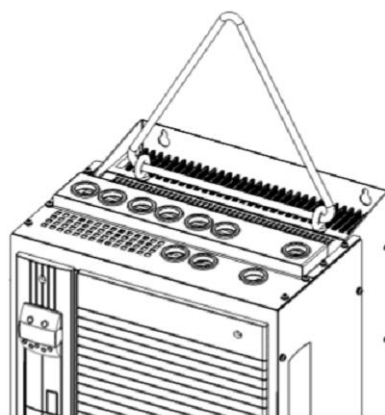

NOTICE

The pull angle must not be smaller than 60°.

- Use appropriate lifting means and a crane to lift the frequency inverter up carefully. Bring the device into vertical position by turning it up on the pallet via the rear lower edge of the case.

NOTICE

- Do not leave the device standing in upright position.

- Move the frequency inverter to its installation position in the electrical cabinet and fix it there, see chapter 6 "Mechanical Installation".
- After mechanical installation, disconnect the device from the crane and remove the crane eyes.

4 Scope of supply

Due to modular hardware components, the frequency inverters can be integrated in the automation concept easily. The scope of delivery described can be supplemented by optional components and adapted to the customer-specific requirements. The plug-in type of connection terminals enable a safe function and quick and easy assembly.

4.1 Sizes 1 and 2: ACT 210 (up to 3.0 kW) and 410 (up to 4.0 kW)

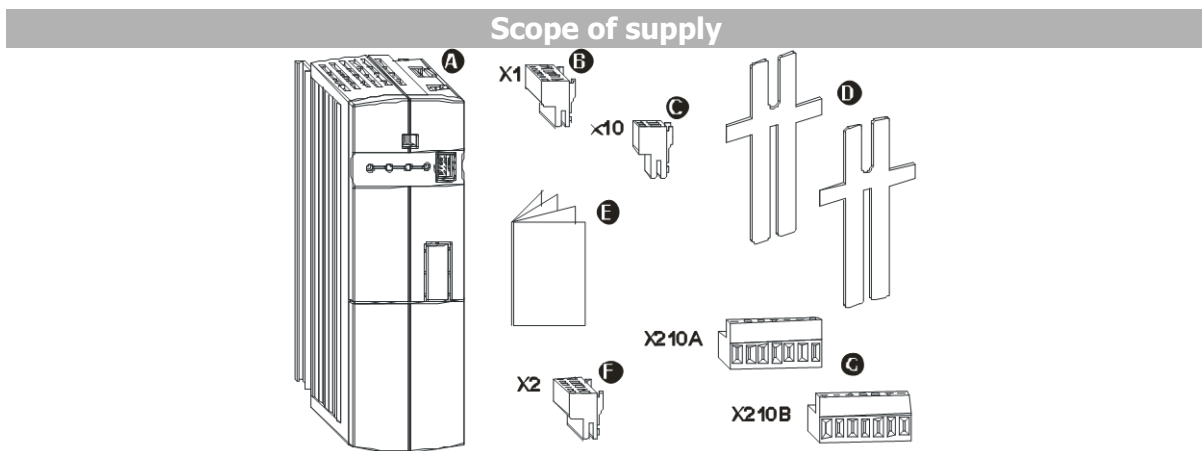

A	Frequency inverter
B	Terminal strip X1 (Phoenix ZEC 1,5/ST7,5). Plug-in terminals for mains connection and DC linking
C	Terminal strip X10 (Phoenix ZEC 1.5/3ST5.0). Plug-in terminals for the relay output
D	Standard fixtures for vertical assembly
E	Quick Start Guide
F	Terminal strip X2 (Phoenix ZEC 1,5/ST7,5). Plug-in terminal for braking resistor and motor connection
G	Control terminals X210A / X210B (Wieland DST85 / RM3.5). Plug-in terminal for connection of the control signals



Please check incoming goods for quality, quantity and type without delay. Obvious defects such as exterior damage of the packing and/or the unit must be notified to the sender within seven days for insurance reasons.

4.2 Sizes 3 and 4: ACT 210 (4.0 to 9.2 kW) and 410 (5.5 to 15.0 kW)

Scope of supply

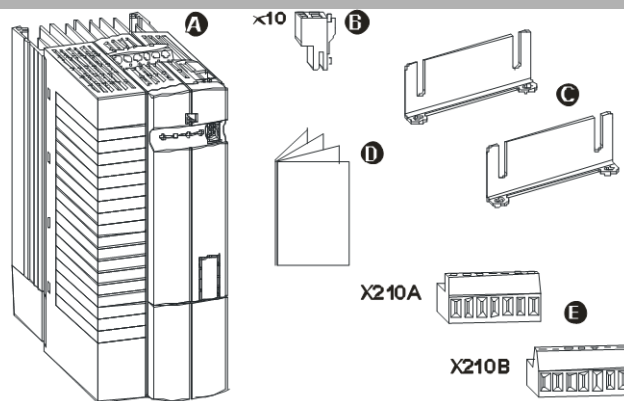

A	Frequency inverter
B	Terminal strip X10 (Phoenix ZEC 1.5/3ST5.0). Plug-in terminals for the relay output
C	Standard fittings with fitting screws (M4x20, M4x60) for vertical assembly
D	Quick Start Guide
E	Control terminals X210A / X210B (Wieland DST85 / RM3.5). Plug-in terminal for connection of the control signals



Please check incoming goods for quality, quantity and type without delay. Obvious defects such as exterior damage of the packing and/or the unit must be notified to the sender within seven days for insurance reasons.

4.3 Size 5 ACT410 (18.5 to 30.0 kW)

Scope of supply

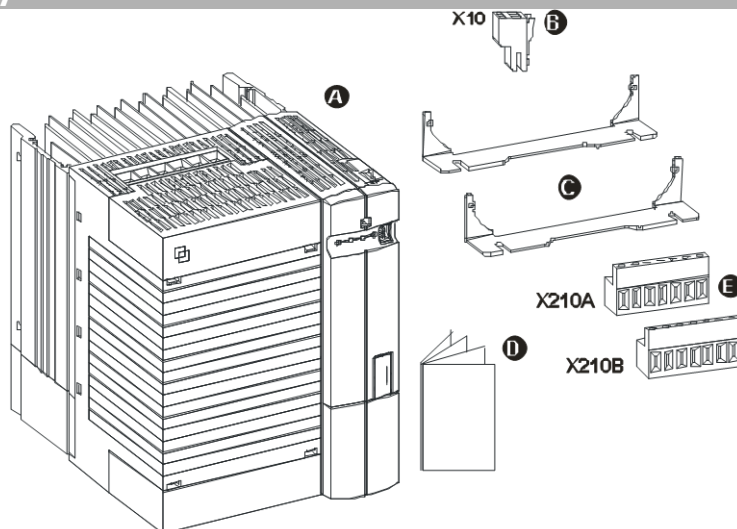

A	Frequency inverter
B	Terminal strip X10 (Phoenix ZEC 1.5/3ST5.0) Plug-in terminals for the relay output
C	Standard fittings with fitting screws (M4x20, M4x70) for vertical assembly
D	Quick Start Guide
E	Control terminals X210A / X210B (Wieland DST85 / RM3.5) Plug-in terminal for connection of the control signals



Please check incoming goods for quality, quantity and type without delay. Obvious defects such as exterior damage of the packing and/or the unit must be notified to the sender within seven days for insurance reasons.

4.4 Size 6 ACT410 (37.0 to 65.0 kW)

Scope of supply

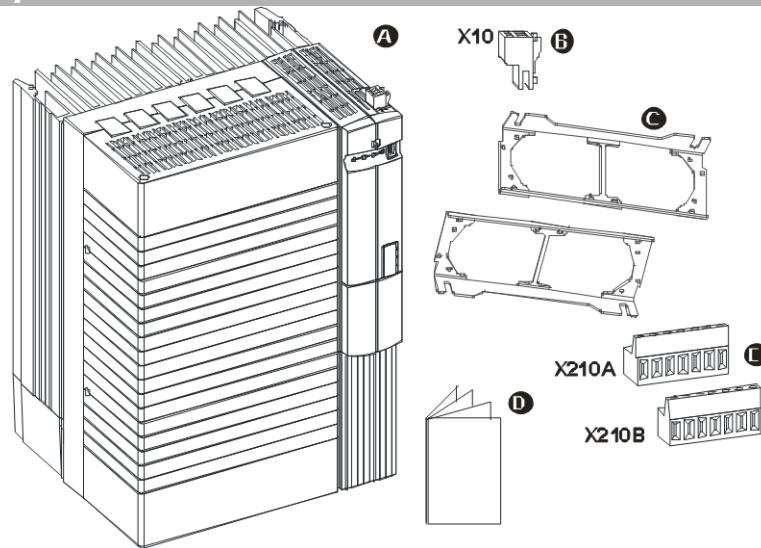

A	Frequency inverter
B	Terminal strip X10 (Phoenix ZEC 1.5/3ST5.0). Plug-in terminals for the relay output
C	Standard fittings with fitting screws (M5x20) for vertical assembly
D	Quick Start Guide
E	Control terminals X210A / X210B (Wieland DST85 / RM3.5). Plug-in terminal for connection of the control signals



Please check incoming goods for quality, quantity and type without delay. Obvious defects such as exterior damage of the packing and/or the unit must be notified to the sender within seven days for insurance reasons.

4.5 Size 7 ACT410 (75.0 to 160.0 kW)

Scope of supply

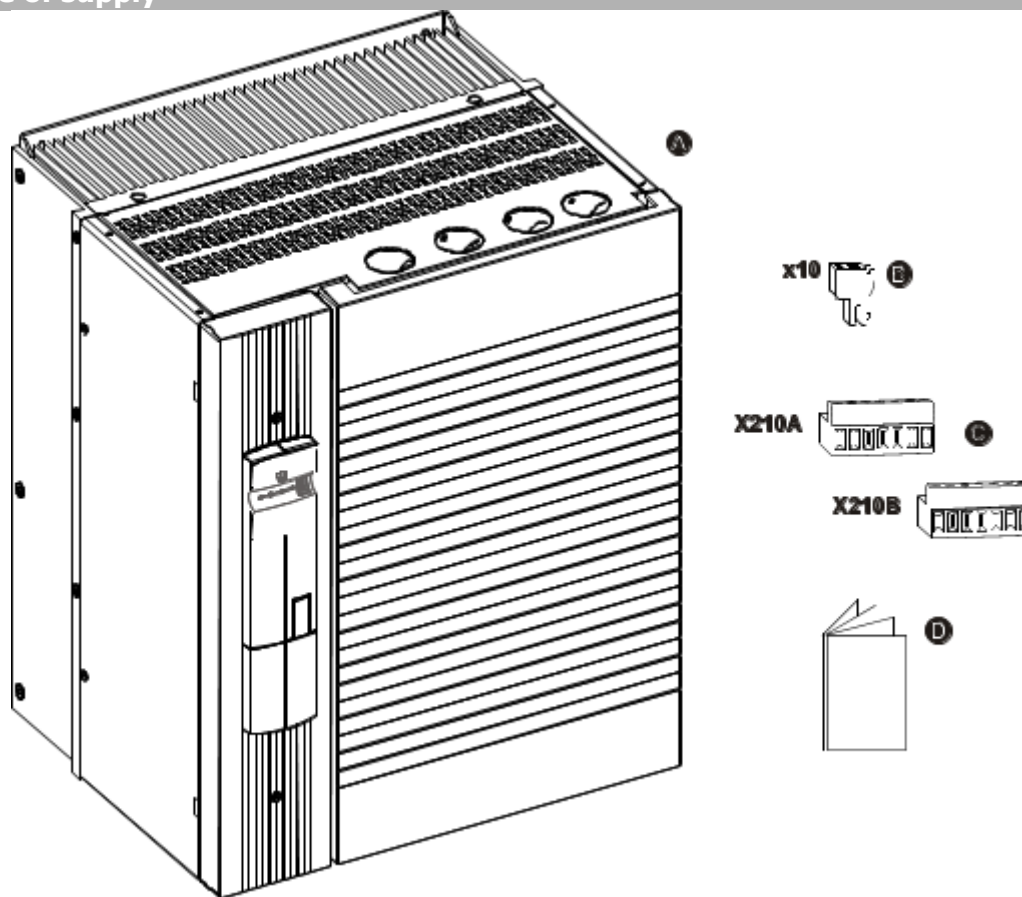

A	Frequency inverter
B	Terminal strip X10 (Phoenix ZEC 1.5/3ST5.0) Plug-in terminals for the relay output
C	Control terminals X210A / X210B (Wieland DST85 / RM3.5) Plug-in terminal for connection of the control signals
D	Quick Start Guide



Please check incoming goods for quality, quantity and type without delay. Obvious defects such as exterior damage of the packing and/or the unit must be notified to the sender within seven days for insurance reasons.

5 Technical Data

CAUTION



Device defect and motor defect

The recommended motor shaft power indicated in the technical data applies to IE1 motors only. Ignoring the possible DC-link currents may decrease the motor product life and may damage the inverter.

- Always verify the applicable operation parameters with regard to the particular motor type and inverter type combination.
- Adapt software parameters if necessary.

5.1 General technical data

CE conformity	The ACT frequency inverters meet the requirements of the low voltage directive 2014/35/EU and DIN EN 61800-5-1.
EMC directive	For proper installation of the frequency inverter in order to meet the requirements of EN 61800-3, please comply with the installation instructions in these operating instructions.
Interference immunity	The ACT frequency inverters meet the requirements of EN 61800-3 for use in industrial environments.
UL Approval	The frequency inverters marked with the UL label according to UL508c also meet the requirements of the CSA Standard C22.2-No. 14.
Ambient temperature	Storage: -25 ... 55°C Transport: -25 ... 70°C Operation: 0...55°C; as from 40 °C power reduction should be considered.
Ambient pressure	70 ... 106 kPa
Environmental class	Operation: 3K3 (EN60721-3-3) Relative humidity Air cooling: 15...85%, no water condensation In addition, the following environmental conditions must be considered for operation according to DIN EN 60721-3-3: 3Z1 (negligible thermal radiation) 3B1 (no biological impact) 3C1 (chemically active substances, limits as per standard) 3S1 (mechanically active substances, no sand in air, limits as per standard) 3M4 (mechanical vibration and shocks, limits as per standard)
Ingress protection rating	IP20 if covers and connection terminals are used properly.
Altitude of installation	Up to 1000 m at rated specifications. Up to 4000 m at reduced power.
Storage	Storage according to EN 61800-5-1. After one year of storage, connect the device to mains voltage for 60 minutes.
Permitted grid types	The frequency inverter may be operated in TN, TT and IT grid types. Precautions must be taken for operation in IT grids, see chapter 7 "Electrical Installation". Operation in a corner-grounded TN grid shall not be permissible.

Vibration and shock resistance	
Sine	According to DIN EN 60068-2-6 Fc
Shock / Half-Sine	According to DIN EN 60068-2-27 Ea
Max. permissible short-circuit current to be expected with mains supply	Up to 132 kW device power (size 7): 5 kA;
Contamination level	The frequency inverters are designed for Pollution Degree 2.
Overvoltage category	The frequency inverters are designed for Overvoltage Category III. Overvoltage Category III for relay connector circuit up to 2000 m altitude. Overvoltage Category III for relay connector circuit above 2000 m altitude.
Functions	<ul style="list-style-type: none"> – Control methods adjusted to motors and application (configuration). – Various protection functions for motor and frequency inverter. – Positioning absolute or relative to a reference point. – Special brake control and load detection for lifting gear. – S-ramps for jerk limitation during acceleration and deceleration. – Technology (PI) controller. – Parameterizable Master-Slave operation via system bus. – Error memory. – Simplified and extended control via PC (commissioning, parameterization, data set backup, diagnosis with Scope).
Parameterization	<ul style="list-style-type: none"> – Freely programmable digital inputs and outputs. – Various logic modules for linking and processing of signals. – Four separate data sets incl. motor parameters.



If required by the customer, the switching frequency may be increased if the output current is reduced at the same time. Comply with the applicable standards and regulations for this operating point.

5.2 Technical data of control electronics

Control terminal X210A		Control terminal X210B	
X210A.1	DC 20 V output ($I_{\max}=180$ mA)	X210B.1	Digital input ¹⁾
X210A.2	Ground 20 V/ Ground 24 V (ext.)	X210B.2	GND
X210A.3	Digital input Controller Release	X210B.3	Digital output ¹⁾
X210A.4	Digital inputs ¹⁾	X210B.4	Multi-function output ¹⁾ (voltage signal proportional actual frequency value, factory setting)
X210A.5		X210B.5	Supply voltage DC 10 V for reference value potentiometer, ($I_{\max}=4$ mA)
X210A.6		X210B.6	Multi-function input ¹⁾ (Reference speed 0 ... +10 V, factory setting)
X210A.7		X210B.7	Ground 10 V

Relay output X10

S3OUT.1	Monitoring function (factory setting)
---------	---------------------------------------

¹⁾ The control terminals are freely configurable.



By default, the different configurations occupy the control terminals with certain settings. These settings can be adjusted to the specific application, and various functions can be assigned freely to the control terminals.

Technical data of the control terminals
<p>Digital inputs (X210A.3...X210B.1): Low Signal: DC 0...3 V, High Signal: DC 12...30 V, Input resistance: 2.3 kΩ, response time: 16 ms, PLC compatible X210A.6 and X210A.7 additional: frequency signal: DC 0 V...30 V, 10 mA at DC 24 V, $f_{\max}=150$ kHz</p>
<p>Digital output (X210B.3): Low Signal: DC 0...3 V, High Signal: DC 12...30 V, maximum output current: 40 mA, PLC compatible</p>
<p>Multi-function output (X210B.4): analog signal: DC 24 V, maximum output current: 40 mA, pulse-width modulated ($f_{\text{PWM}}=116$ Hz), digital signal: Low Signal: DC 0...3 V, High Signal: DC 12...30 V, output current: 40 mA, PLC compatible, frequency signal: output voltage: DC 0...24 V, maximum output current: 40 mA, maximum output frequency: 150 kHz</p>
<p>Multi-function input (X210B.6): analog signal: input voltage: DC 0... 10 V ($R_i=70$ kΩ), input current: DC 0...20 mA ($R_i=500$ Ω), digital signal: Low Signal: DC 0...3 V, High Signal: DC 12 V...30 V, response time: 16 ms, PLC compatible</p>
<p>Conductor cross section: The terminals are suitable for the conductor cross sections: with wire end ferrule: 0.25...1.0 mm² without wire end ferrule: 0.14...1.5 mm²</p>

5.3 ACT210 (0.55 up to 3.0 kW, 230 V)

Type								
ACT210			-05	-07	-09	-11	-13	-15
Size			1			2		
Output motor side								
Recommended shaft output	P	kW	0.55	0.75	1.1	1.5	2.2	3.0 ⁴⁾
Output current	I	A	3.0	4.0	5.4 ⁵⁾	7.0	9.5	12.5 ^{4) 5)}
Long-term overload current (60 s)	I	A	4.5	6.0	7.3	10.5	14.3	16.2
Short-term overload current (1 s)	I	A	6.0	8.0	8.0	14.0	19.0	19.0
Output voltage	U	V	Maximum up to mains voltage, three-phase					
Protection	-	-	Short circuit / earth fault proof					
Rotary field frequency	f	Hz	0 ... 599, depending on switching frequency					
Switching frequency	f	kHz	2. 4. 8. 12. 16					
Output brake resistor								
min. brake resistor	R	Ω	100	100	100	37	37	37
Recommended brake resistor (U _{dBC} = 385 V)	R	Ω	230	160	115	75	55	37
Input, mains side								
Mains current ³⁾ , 3ph/PE 1ph/N/PE; 2ph/PE	I	A	3 5.4	4 7.2	5.5 ¹⁾ 9.5 ²⁾	7 13.2	9.5 16.5 ²⁾	10.5 ¹⁾ 16.5 ^{2) 4)} 7)
Mains voltage	U	V	184 ... 264					
Mains frequency	f	Hz	45 ... 66					
Fuse 3ph/PE 1ph/N/PE; 2ph/PE	I	A	6 10	10 16	16 20	16 20	16 20	16 20
UL Type 250 VAC RK5, 3ph/PE 1ph/N/PE; 2ph/PE	I	A	6 10	10 15	15 20	15 20	15 20	15 20
Mechanics								
Dimensions	HxWxD	mm	190x60x175			250x60x175		
Weight (approx.)	m	kg	1.2			1.6		
Degree of protection	-	-	IP20 (EN60529)					
Terminals	A	mm ²	0.2 ... 1.5					
Form of assembly	-	-	vertical					
Ambient conditions								
Energy dissipation (2 kHz switching frequency)	P	W	43	53	73	84	115	170
Coolant temperature	T _n	°C	0 ... 40 (3K3 DIN IEC 721-3-3)					
Storage temperature	T _L	°C	-25 ... 55					
Transport temperature	T _T	°C	-25 ... 70					
Rel. air humidity	-	%	15 ... 85; not condensing					

Output current ⁶⁾

Frequency inverter nominal power	Switching frequency				
	2 kHz	4 kHz	8 kHz	12 kHz	16 kHz
0.55 kW	3.0 A	3.0 A	3.0 A	2.5 A	2.0 A
0.75 kW	4.0 A	4.0 A	4.0 A	3.4 A	2.7 A
1.1 kW	5.4 A ²⁾	5.4 A ^{2) 5)}	5.4 A ^{2) 5)}	4.5 A ^{2) 5)}	3.7 A ⁵⁾
1.5 kW	7.0 A	7.0 A	7.0 A	5.9 A	4.8 A
2.2 kW	9.5 A ²⁾	9.5 A ²⁾	9.5 A ²⁾	8.0 A ²⁾	6.5 A
3.0 kW ^{2) 4)}	12.5 A ¹⁾	12.5 A ^{1) 5)}	12.5 A ^{1) 5)}	10.5 A ^{1) 5)}	8.5 A ⁵⁾

¹⁾ Three-phase connection requires a commutating choke.

²⁾ One- and two-phase connection requires a commutating choke.

³⁾ Mains current with relative mains impedance $\geq 1\%$ (see chapter 7 "Electrical Installation").

⁴⁾ Maximum output current is 9.5 A for one- and two-phase connection.

⁵⁾ Switching frequency is reduced in thermal limit range

⁶⁾ Maximum current in continuous operation

7) The device for one-phase connection is not included in the product catalogue. It is available on demand.

5.4 ACT210 (4.0 up to 9.2 kW, 230 V)

ACT210			-18	-19	-21	-22
Size			3		4	
Output motor side						
Recommended shaft output	P	kW	4.0	5.5	7.5 ⁴⁾	9.2
Output current	I	A	18.0	22.0	32.0	35.0
Long-term overload current (60 s)	I	A	26.3	30.3	44.5	51.5
Short-term overload current (1 s)	I	A	33.0	33.0	64.0	64.0
Output voltage	U	V	Maximum up to mains voltage, three-phase			
Protection	-	-	Short circuit / earth fault proof			
Rotary field frequency	f	Hz	0 ... 599, depending on switching frequency			
Switching frequency	f	kHz	2, 4, 8, 12, 16			
Output brake resistor						
min. brake resistor	R	Ω	24	24	12	12
Recommended brake resistor (U _{dBC} = 385 V)	R	Ω	30	24	16	12
Input, mains side						
Mains current ³⁾ , 3ph/PE 1ph/N/PE; 2ph/PE	I	A	18 28 ^{2) 7)}	20 ¹⁾ - ⁴⁾	28.2 ¹⁾ - ⁴⁾	35.6 ¹⁾ - ⁴⁾
Mains voltage	U	V	184 ... 264			
Mains frequency	f	Hz	45 ... 66			
Fuse 3ph/PE 1ph/N/PE; 2ph/PE	I	A	25 35	25 - ⁴⁾	35 - ⁴⁾	50 - ⁴⁾
UL Type 250 VAC RK5, 3ph/PE 1ph/N/PE; 2ph/PE	I	A	20	25	30	40
Mechanics						
Dimensions	HxWxD	mm	250x100x200		250x125x200	
Weight (approx.)	m	kg	3.0		3.7	
Degree of protection	-	-	IP20 (EN60529)			
Terminals	A	mm ²	0.2 ... 6		0.2 ... 16	
Form of assembly	-	-	vertical			
Ambient conditions						
Energy dissipation (2 kHz switching frequency)	P	W	200	225	310	420
Coolant temperature	T _n	°C	0 ... 40 (3K3 DIN IEC 721-3-3)			
Storage temperature	T _L	°C	-25 ... 55			
Transport temperature	T _T	°C	-25 ... 70			
Rel. air humidity	-	%	15 ... 85; not condensing			
Output current ⁶⁾						
Frequency inverter nominal power	Switching frequency					
	2 kHz	4 kHz	8 kHz	12 kHz	16 kHz	
4.0 kW	18.0 A ²⁾	18.0 A ²⁾	18.0 A ²⁾	15.1 A ²⁾	12.2 A	
5.5 kW ⁴⁾	23.0 A ¹⁾	22.7 A ^{1), 5)}	22.0 A ^{1), 5)}	18.5 A ⁵⁾	15.0 A ⁵⁾	
7.5 kW ⁴⁾	32.0 A ¹⁾	32.0 A ¹⁾	32.0 A ¹⁾	26.9 A ¹⁾	21.8 A	
9.2 kW ⁴⁾	40.0 A ¹⁾	38.3 A ^{1), 5)}	35.0 A ^{1), 5)}	29.4 A ^{1), 5)}	23.8 A ⁵⁾	

¹⁾ Three-phase connection requires a commutating choke.

²⁾ One- and two-phase connection requires a commutating choke.

³⁾ Mains current with relative mains impedance $\geq 1\%$ (see chapter 7 "Electrical Installation").

⁴⁾ Only three-phase connection

⁵⁾ Switching frequency is reduced in thermal limit range.

⁶⁾ Maximum current in continuous operation

⁷⁾ The device for one-phase connection is not included in the product catalogue. It is available on demand.

5.5 ACT410 (0.55 up to 4.0 kW, 400 V)

Type										
ACT410			-05	-07	-09	-11	-12	-13	-15	-18
Size			1				2			
Output motor side										
Recommended shaft output	P	kW	0.55	0.75	1.1	1.5	1.85	2.2	3.0	4.0
Output current	I	A	1.8	2.4	3.2	3.8 3)	4.2	5.8	7.8	9.0 3)
Long-term overload current (60 s)	I	A	2.7	3.6	4.8	5.7	6.3	8.7	11.7	13.5
Short-term overload current (1 s)	I	A	3.6	4.8	6.4	7.6	8.4	11.6	15.6	18.0
Output voltage	U	V	Maximum up to mains voltage, three-phase							
Protection	-	-	Short circuit / earth fault proof							
Rotary filed frequency	f	Hz	0 ... 599, depending on switching frequency							
Switching frequency	f	kHz	2, 4, 8, 12, 16							
Output brake resistor										
min. brake resistor	R	Ω	300	300	300	300	136	136	136	92
Recommended brake resistor (U _{dbc} = 770 V)	R	Ω	930	634	462	300	300	220	148	106
Input, mains side										
Mains current ²⁾ 3ph/PE	I	A	1.8	2.4	2.8 ¹⁾	3.3 ¹⁾	4.2	5.8	6.8 ¹⁾	7.8 ¹⁾
Mains voltage	U	V	320 ... 528							
Mains frequency	f	Hz	45 ... 66							
Fuse 3ph/PE	I	A	6				10			
UL-Type 600 VAC RK5. 3ph/PE	I	A	6				10			
Mechanics										
Dimensions	HxWxD	mm	190x60x175				250x60x175			
Weight (approx.)	m	kg	1.2				1.6			
Degree of protection	-	-	IP20 (EN60529)							
Terminals	A	mm ₂	0.2 ... 1.5							
Form of assembly	-	-	vertical							
Ambient conditions										
Energy dissipation (2 kHz Switching frequency)	P	W	40	46	58	68	68	87	115	130
Coolant temperature	T _n	°C	0 ... 40 (3K3 DIN IEC 721-3-3)							
Storage temperature	T _L	°C	-25 ... 55							
Transport temperature	T _T	°C	-25 ... 70							
Rel. air humidity	-	%	15 ... 85; not condensing							

Output current ⁴⁾

Frequency inverter nominal power	Switching frequency				
	2 kHz	4 kHz	8 kHz	12 kHz	16 kHz
0.55 kW	1.8 A	1.8 A	1.8 A	1.5 A	1.2 A
0.75 kW	2.4 A	2.4 A	2.4 A	2.0 A	1.6 A
1.1 kW	3.2 A ¹⁾	3.2 A ¹⁾	3.2 A ¹⁾	2.7 A ¹⁾	2.2 A
1.5 kW ¹⁾	3.8 A	3.8 A ³⁾	3.8 A ³⁾	3.2 A ³⁾	2.6 A ³⁾
1.85 kW	4.2 A	4.2 A	4.2 A	3.5 A	2.9 A
2.2 kW	5.8 A	5.8 A	5.8 A	4.9 A	3.9 A
3.0 kW	7.8 A ¹⁾	7.8 A ¹⁾	7.8 A ¹⁾	6.6 A ¹⁾	5.3 A
4.0 kW	9.0 A ¹⁾	9.0 A ^{1) 3)}	9.0 A ^{1) 3)}	7.6 A ^{1) 3)}	6.1 A ³⁾

1) Three-phase connection requires a commutating choke.

2) Mains current with relative mains impedance $\geq 1\%$ (see chapter 7 "Electrical Installation").

3) Switching frequency is reduced in thermal limit range.

4) Maximum current in continuous operation

5.6 ACT410 (5.5 up to 15.0 kW, 400 V)

Type							
ACT410			-19	-21	-22	-23	-25
Size			3			4	
Output motor side							
Recommended shaft output	P	kW	5.5	7.5	9.2	11.0	15.0
Output current	I	A	14.0	18.0	22.0 3)	25.0	32.0
Long-term overload current (60 s)	I	A	21.0	26.3	30.3	37.5	44.5
Short-term overload current (1 s)	I	A	28.0	33.0	33.0	50.0	64.0
Output voltage	U	V	Maximum up to mains voltage, three-phase				
Protection	-	-	Short circuit / earth fault proof				
Rotary filed frequency	f	Hz	0 ... 599, depending on switching frequency				
Switching frequency	f	kHz	2, 4, 8, 12, 16				
Output brake resistor							
min. brake resistor	R	Ω	48	48	48	32	32
Recommended brake resistor (U _{dBC} = 770 V)	R	Ω	80	58	48	48	32
Input, mains side							
Mains current ²⁾ 3ph/PE	I	A	14.2	15.8 ¹⁾	20.0 ¹⁾	26.0	28.2 ¹⁾
Mains voltage	U	V	320 ... 528				
Mains frequency	f	Hz	45 ... 66				
Fuse 3ph/PE	I	A	16	25		35	
UL-Type 600 VAC RK5. 3ph/PE	I	A	20			30	40
Mechanics							
Dimensions	HxWxD	mm	250x100x200			250x125x200	
Weight (approx.)	m	kg	3.0			3.7	
Degree of protection	-	-	IP20 (EN60529)				
Terminals	A	mm ²	0.2 ... 6			0.2 ... 16	
Form of assembly	-	-	vertical				
Ambient conditions							
Energy dissipation (2 kHz Switching frequency)	P	W	145	200	225	240	310
Coolant temperature	T _n	°C	0 ... 40 (3K3 DIN IEC 721-3-3)				
Storage temperature	T _L	°C	-25 ... 55				
Transport temperature	T _T	°C	-25 ... 70				
Rel. air humidity	-	%	15 ... 85; not condensing				
Output current							
Frequency inverter nominal power	Switching frequency						
	2 kHz	4 kHz	8 kHz	12 kHz	16 kHz		
5.5 kW	14.0 A	14.0 A	14.0 A	11.8 A	9.5 A		
7.5 kW	18.0 A ¹⁾	18.0 A ¹⁾	18.0 A ¹⁾	15.1 A ¹⁾	12.2 A		
9.2 kW ¹⁾	23.0 A	22.7 A ³⁾	22.0 A ³⁾	18.5 A ³⁾	15.0 A ³⁾		
11 kW	25.0 A	25.0 A	25.0 A	21.0 A	17.0 A		
15 kW	32.0 A ¹⁾	32.0 A ¹⁾	32.0 A ¹⁾	26.9 A ¹⁾	21.8 A		

1) Three-phase connection requires a commutating choke.

2) Mains current with relative mains impedance $\geq 1\%$ (see chapter 7 "Electrical Installation").

3) Switching frequency is reduced in thermal limit range.

4) Maximum current in continuous operation

5.7 ACT410 (18.5 up to 30.0 kW, 400 V)

Type					
ACT410			-27	-29	-31
Size			5		
Output, motor side					
Recommended shaft output	P	kW	18.5	22.0	30.0
Output current	I	A	40.0	45.0	60.0
Long-term overload current (60 s)	I	A	60.0	67.5	90.0
Short-term overload current (1 s)	I	A	80.0	90.0	120.0
Output voltage	U	V	Maximum up to mains voltage, three-phase		
Protection	-	-	Short circuit / earth fault proof		
Rotary filed frequency	f	Hz	0 ... 599, depending on switching frequency		
Switching frequency	f	kHz	2, 4, 8		
Output brake resistor					
min. brake resistor	R	Ω	16		
Recommended brake resistor (U _{dBC} = 770 V)	R	Ω	26	22	16
Input, mains side					
Mains current ²⁾ 3ph/PE	I	A	42.0	50.0	58.0 ¹⁾
Mains voltage	U	V	320 ... 528		
Mains frequency	f	Hz	45 ... 66		
Fuse 3ph/PE	I	A	50	63	
UL-Type 600 VAC RK5. 3ph/PE	I	A	50	60	
Mechanics					
Dimensions	HxWxD	mm	250x200x260		
Weight (approx.)	m	kg	8		
Degree of protection	-	-	IP20 (EN60529)		
Terminals	A	mm ²	up to 25		
Form of assembly	-	-	vertical		
Ambient conditions					
Energy dissipation (2 kHz Switching frequency)	P	W	445	535	605
Coolant temperature	T _n	°C	0 ... 40 (3K3 DIN IEC 721-3-3)		
Storage temperature	T _L	°C	-25 ... 55		
Transport temperature	T _T	°C	-25 ... 70		
Rel. air humidity	-	%	15 ... 85; not condensing		

Output current ³⁾

Frequency inverter nominal power	Switching frequency		
	2 kHz	4 kHz	8 kHz
18.5 kW	40.0 A	40.0 A	40.0 A
22 kW	45.0 A	45.0 A	45.0 A
30 kW	60.0 A ¹⁾	60.0 A ¹⁾	60.0 A ¹⁾

1) Three-phase connection requires a commutating choke.

2) Mains current with relative mains impedance $\geq 1\%$ (see chapter 7 "Electrical Installation").

3) Maximum current in continuous operation

5.8 ACT410 (37.0 up to 65.0 kW, 400 V)

Type						
ACT410			-33	-35	-37	-39
Size			6			
Output, motor side						
Recommended shaft output	P	kW	37.0	45.0	55.0	65.0
Output current	I	A	75.0	90.0	110.0	125.0
Long-term overload current (60 s)	I	A	112.5	135.0	165.0	187.5
Short-term overload current (1 s)	I	A	150.0	180.0	220.0	250.0
Output voltage	U	V	Maximum up to mains voltage, three-phase			
Protection	-	-	Short circuit / earth fault proof			
Rotary filed frequency	f	Hz	0 ... 599, depending on switching frequency			
Switching frequency	f	kHz	2. 4. 8			
Output brake resistor ⁵⁾						
min. brake resistor	R	Ω	7.5			
Recommended brake resistor (U _{dBC} = 770 V)	R	Ω	13	11	9	7.5
Input, mains side						
Mains current ²⁾ 3ph/PE	I	A	87.0	104.0	105.0 ¹⁾	120.0 ¹⁾
Mains voltage	U	V	320 ... 528			
Mains frequency	f	Hz	45 ... 66			
Fuse 3ph/PE	I	A	100	125	125	125
UL-Type 600 VAC RK5. 3ph/PE	I	A	100	125	125	125
Mechanics						
Dimensions	HxWxD	mm	400x275x260			
Weight (approx.)	m	kg	20			
Degree of protection	-	-	IP20 (EN60529)			
Terminals	A	mm ²	up to 70			
Form of assembly	-	-	Vertical			
Ambient conditions						
Energy dissipation (2 kHz Switching frequency)	P	W	665	830	1080	1255
Coolant temperature	T _n	°C	0 ... 40 (3K3 DIN IEC 721-3-3)			
Storage temperature	T _L	°C	-25 ... 55			
Transport temperature	T _T	°C	-25 ... 70			
Rel. air humidity	-	%	15 ... 85; not condensing			
Output current ⁴⁾						
Frequency inverter nominal power	Switching frequency					
	2 kHz	4 kHz	8 kHz			
37 kW	75.0 A	75.0 A	75.0 A			
45 kW	90.0 A	90.0 A	90.0 A			
55 kW	110.0 A ¹⁾	110.0 A ¹⁾	110.0 A ¹⁾			
65 kW	125.0 A ^{1), 3)}	125.0 A ^{1), 3)}	125.0 A ^{1), 3)}			

1) Three-phase connection requires a commutating choke.

2) Mains current with relative mains impedance $\geq 1\%$ (see chapter 7 "Electrical Installation").

3) Switching frequency is reduced in thermal limit range

4) Maximum current in continuous operation

5) Optional the frequency inverter of this size is purchasable without brake transistor.

5.9 ACT410 (75.0 up to 132.0 kW, 400 V)

Type						
ACT410			-43	-45	-47	-49
Size			7			
Output, motor side						
Recommended shaft output	P	kW	75.0	90.0	110.0	132.0
Output current	I	A	150.0	180.0	210.0	250.0
Long-term overload current (60 s)	I	A	225.0	270.0	315.0	332.0
Short-term overload current (1 s)	I	A	270.0	325.0	375.0	375.0
Output voltage	U	V	Maximum up to mains voltage, three-phase			
Protection	-	-	Short circuit / earth fault proof			
Rotary filed frequency	f	Hz	0 ... 1000, depending on switching frequency			
Switching frequency	f	kHz	2, 4, 8			
Output brake resistor (external) ⁵⁾						
min. brake resistor	R	Ω	4.5		3.0	
Recommended brake resistor (U _{dBC} = 770 V)	R	Ω	6.1	5.1	4.1	3.8
Input, mains side						
Mains current ²⁾ 3ph/PE	I	A	143.0 ¹⁾	172.0 ¹⁾	208.0 ¹⁾	249.0 ¹⁾
Mains voltage	U	V	320 ... 528			
Mains frequency	f	Hz	45 ... 66			
Fuses 3ph	I	A	160	200	250	315
Fuses according to UL ⁶⁾ Cooper Bussmann	Type		FWH-250A	FWH-300A	FWH-350A	FWH-400A
Mechanics						
Dimensions	HxWxD	mm	510x412x351			
Weight (approx.)	m	kg	45		48	
Degree of protection	-	-	IP20 (EN60529)			
Terminals	A	mm ²	up to 2 x 95			
Form of assembly	-	-	Vertical			
Ambient conditions						
Energy dissipation (2 kHz Switching frequency)	P	W	1600	1900	2300	2800
Coolant temperature	T _n	°C	0 ... 40 (3K3 DIN IEC 721-3-3)			
Storage temperature	T _L	°C	-25 ... 55			
Transport temperature	T _T	°C	-25 ... 70			
Rel. air humidity	-	%	15 ... 85; not condensing			

Output current ⁴⁾			
Frequency inverter nominal power	Switching frequency		
	2 kHz	4 kHz	8 kHz
75 kW	150 A	150 A	150 A
90 kW	180 A	180 A	180 A
110 kW	210 A	210 A	210 A3)
132 kW	250 A	250 A	250 A3)

- 1) Three-phase connection requires a commutating choke.
- 2) Mains current with relative mains impedance $\geq 1\%$ (see chapter 7 "Electrical Installation").
- 3) Switching frequency is reduced in thermal limit range
- 4) Maximum current in continuous operation
- 5) Optional the frequency inverter of this size is purchasable without brake transistor.
- 6) For the UL conform fuse protection the mentioned fuses of the company Cooper Bussmann must be used. Other fuses must not be used for the UL conform fuse protection.

5.10 Operation Diagrams

The technical data of the frequency inverters refer to the nominal point which was selected to enable a wide range of applications. A functionally and efficient dimensioning (de-rating) of the frequency inverters is possible based on the following diagrams.

Site altitude

Power reduction (Derating),
5%/1000 m above sea level,
 $h_{max} = 4000$ m

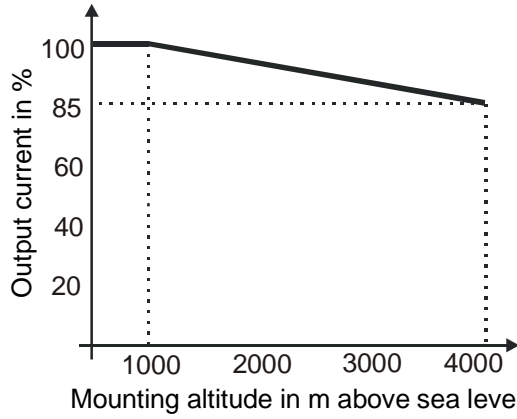

max. coolant temperature,
3.3 °C/1000 m above sea level,

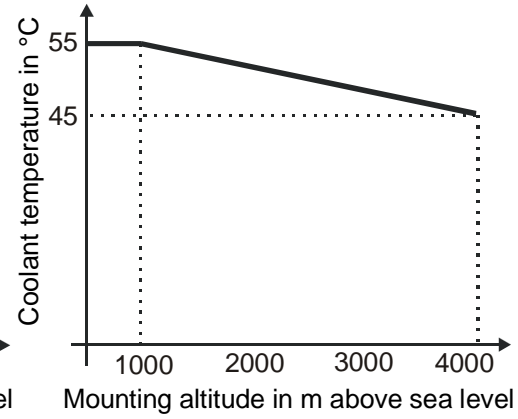

Coolant temperature

Power reduction (Derating)
2.5%/K upper 40 °C, $T_{max} = 55$ °C

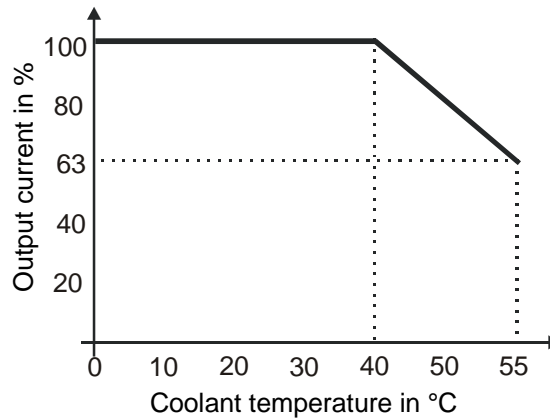

Mains voltage

Reduction of output current at constant output power (Derating)
0.22%/ V upper 400 V, $U_{max} = 480$ V

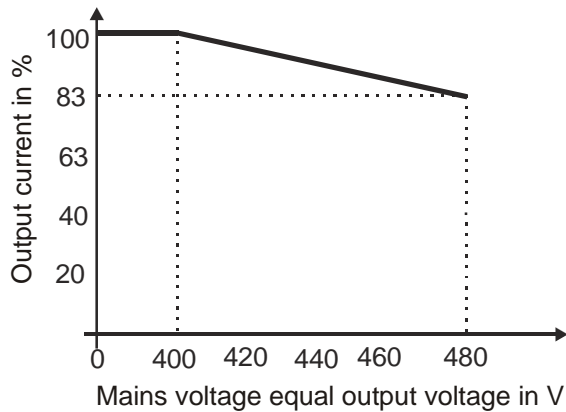

6 Mechanical Installation

The frequency inverters of degree of protection IP20 are designed, as a standard, for installation in electrical cabinets.

- During installation, both the installation and the safety instructions as well as the device specifications must be complied with.

WARNING



Inappropriate handling of the device may result in serious physical injuries or major material damage.

- To avoid serious physical injuries or major material damage, only qualified persons are allowed to Work at the device.

WARNING



Intrusion of foreign particles

Risk of short circuit and fire!

- During assembly, make sure that no foreign particles (e.g. chips, dust, wires, screws, tools) can get inside the frequency inverter.
- The frequency inverter complies with IP20 ingress protection rating only if the covers, components and terminals are mounted properly.
- Overhead installation or installation in horizontal position is not permissible.

6.1 Air circulation

CAUTION



Insufficient air circulation

Short circuits and fire may cause major material damage, which may in turn result in physical injuries.

- Mount the devices with sufficient clearance to other components so that the cooling air can circulate freely.
- Avoid soiling by grease and air pollution by dust, aggressive gases, etc.
- Do not cover fan inlet and outlet openings.

For cooling the frequency inverters, air is taken in through openings in the bottom plate. The air coming from below heats up and escapes through openings in the top of the case.

6.2 ACT210 (up to 3.0 kW) and ACT410 (up to 4.0 kW)

The frequency inverter is mounted in a vertical position on the assembly panel by means of the standard fittings.

The following illustration shows the different mounting possibilities.

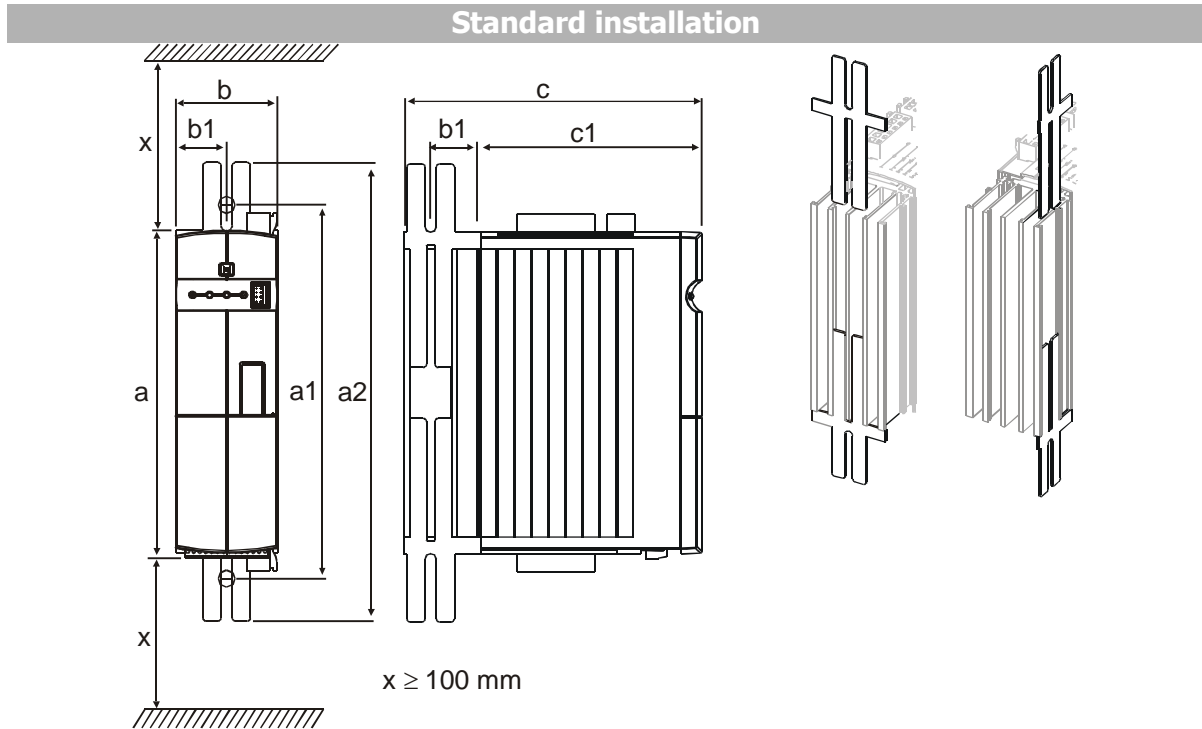

To assemble, insert the long side of the fixing plate in the heat sink and screwing it to the mounting plate.

The dimensions of the device and the installation dimensions are those of the standard device without optional components and are given in millimeters.

		Dimensions in mm			Installation dimensions in mm			
Frequency inverter		a	b	c	a1	a2	b1	c1
ACT210	0.55 kW ... 1.1 kW	190	60	178	210 ... 230	230	30	133
	1.5 kW ... 3.0 kW	250	60	178	270 ... 290	286	30	133
ACT410	0.55 kW ... 1.5 kW	190	60	178	210 ... 230	230	30	133
	1.85 kW ... 4.0 kW	250	60	178	270 ... 290	286	30	133

6.3 ACT210 (4.0 up to 9.2 kW) and ACT410 (5.5 up to 15.0 kW)

The frequency inverter is mounted in a vertical position on the assembly panel by means of the standard fittings. The following illustration shows the standard fitting.

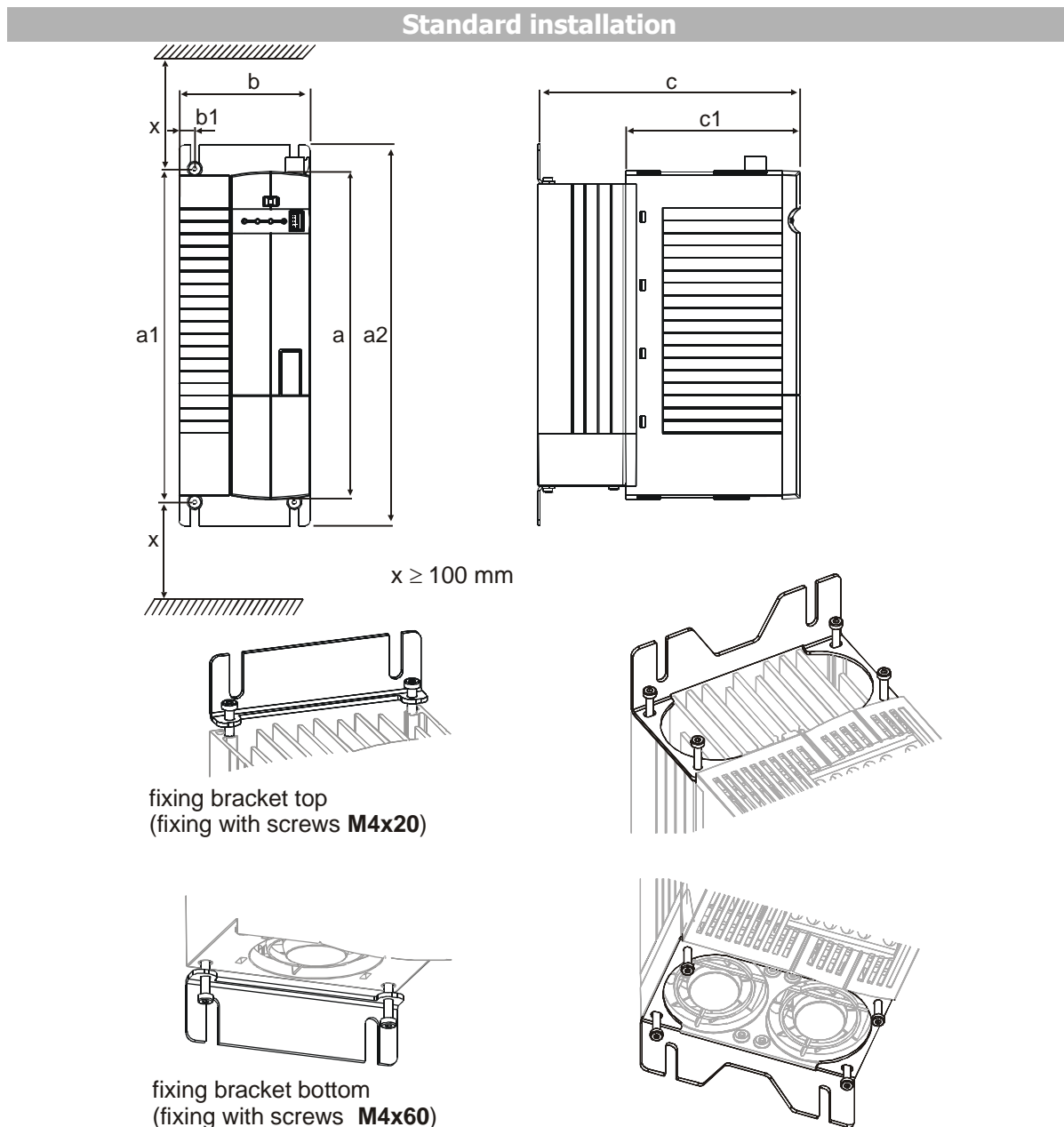

To assemble, screw the two fixing brackets to the heat sink of the frequency inverter and the assembly panel.

The frequency inverters are provided with fixing brackets, which are fitted using four thread-cutting screws.

The dimensions of the device and the installation dimensions are those of the standard device without optional components and are given in millimeters.

		Dimensions in mm			Installation dimensions in mm			
Frequency inverter		a	b	c	a1	a2	b1	c1
ACT210	4.0 ... 5.5 kW	250	100	200	270 ... 290	315	12	133
	7.5 ... 9.2 kW	250	125	200	270 ... 290	315	17.5	133
ACT410	5.5 ... 9.2 kW	250	100	200	270 ... 290	315	12	133
	11.0 ... 15.0 kW	250	125	200	270 ... 290	315	17.5	133

6.4 ACT410 (18.5 up to 30.0 kW)

The frequency inverter is mounted in a vertical position on the assembly panel by means of the standard fittings. The following illustration shows the standard fitting.

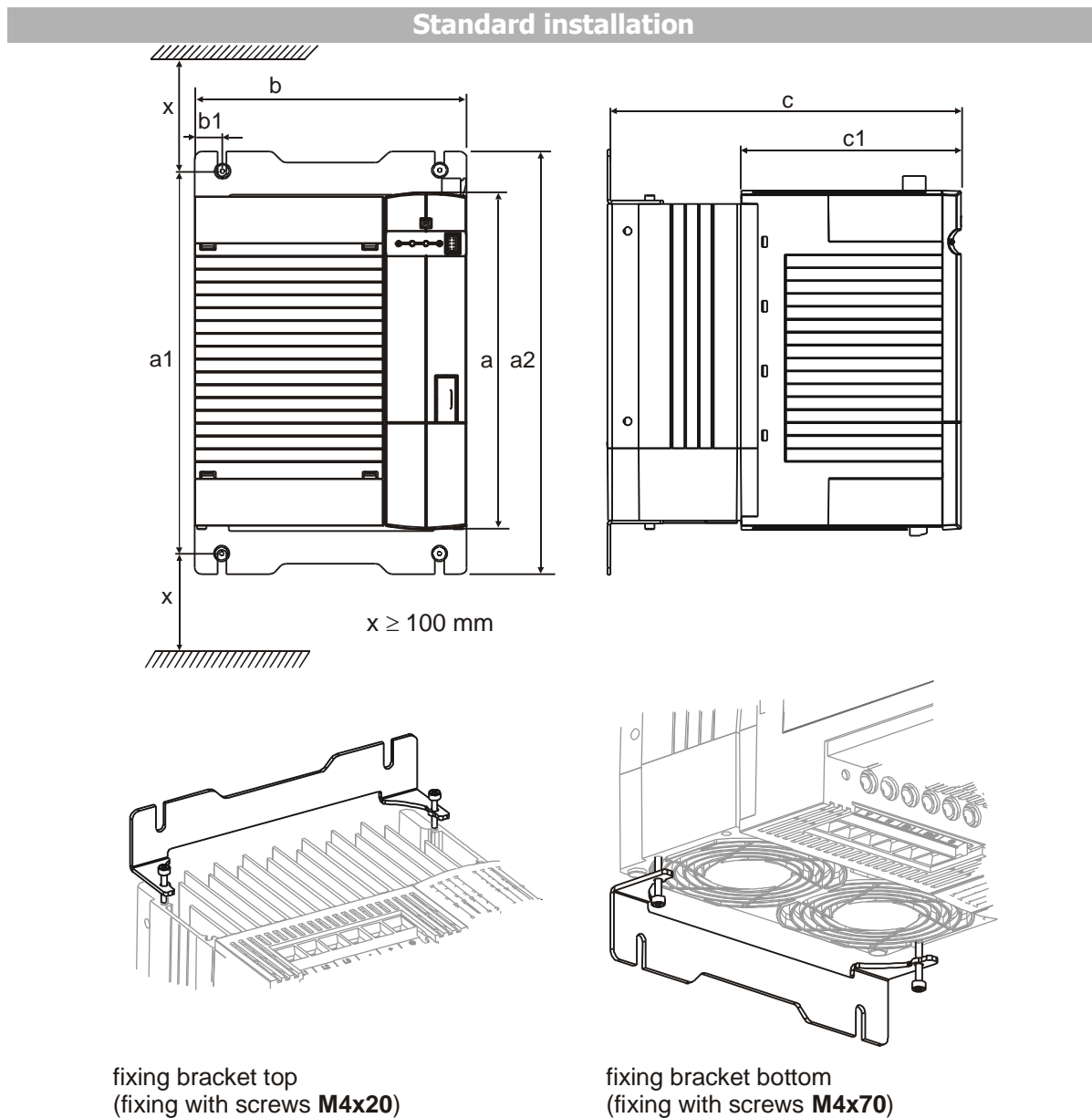

To assemble, screw the two fixing brackets to the heat sink of the frequency inverter and the assembly panel.

The frequency inverters are provided with fixing brackets, which are fitted using four thread-cutting screws. The dimensions of the device and the installation dimensions are those of the standard device without optional components and are given in millimeters.

	Dimensions in mm			Installation dimensions in mm			
Frequency inverter	a	b	c	a1	a2	b1	c1
18.5 kW ... 30.0 kW	250	200	260	270 ... 290	315	20	160

6.5 ACT410 (37.0 up to 65.0 kW)

The frequency inverter is mounted in a vertical position on the assembly panel by means of the standard fittings. The following illustration shows the standard fitting.

Standard installation

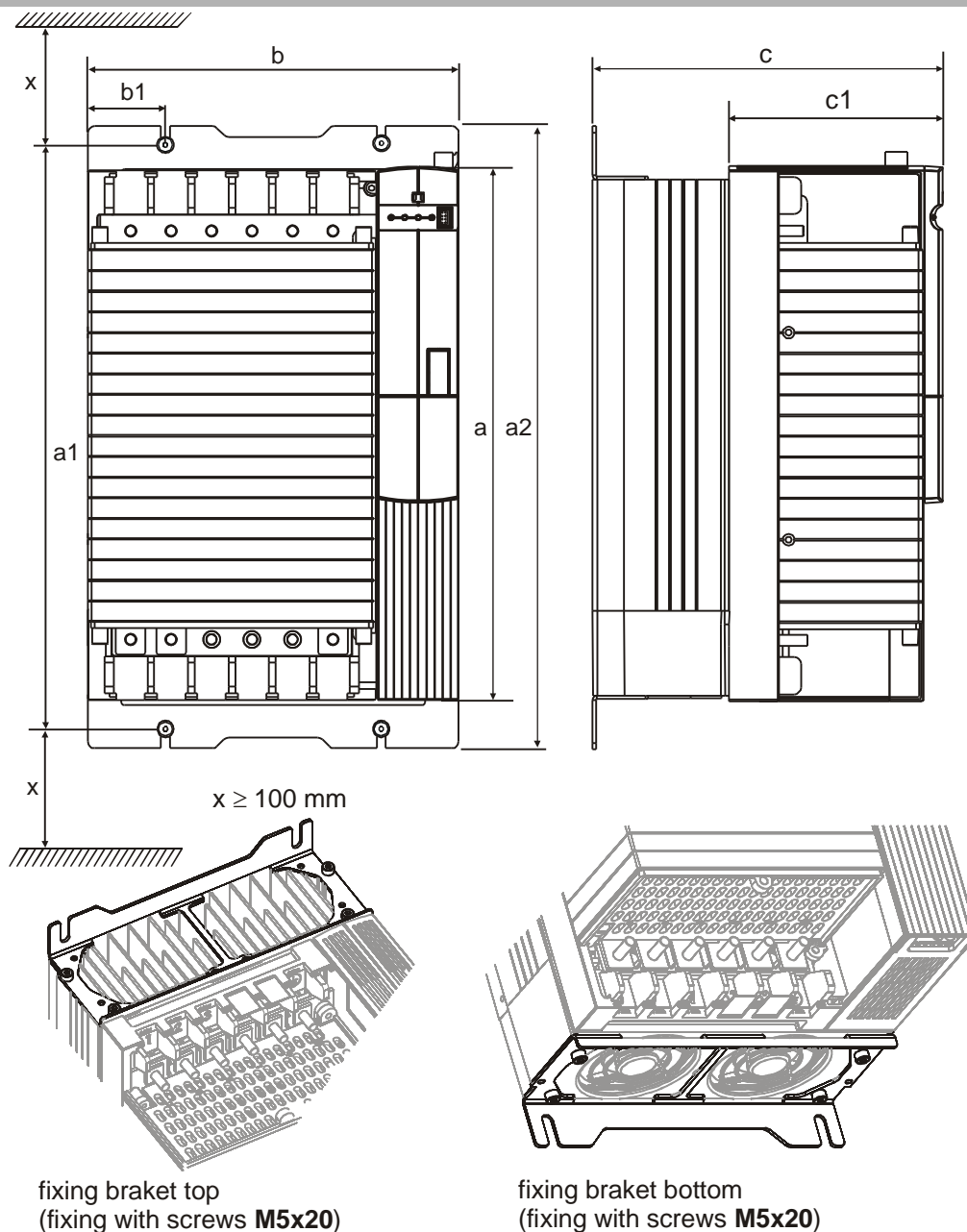

To assemble, screw the two fixing brackets to the heat sink of the frequency inverter and the assembly panel.

The frequency inverters are provided with fixing brackets, which are fitted using four thread-cutting screws. The dimensions of the device and the installation dimensions are those of the standard device without optional components and are given in millimeters.

Dimensions in mm				Installation dimensions in mm			
Frequency inverter	a	b	c	a1	a2	b1	c1
37.0 kW ... 65.0 kW	400	275	260	425 ... 445	470	20	160

6.6 ACT410 (75.0 up to 132.0 kW)

The frequency inverter is mounted in a vertical position on the assembly panel. The following illustration shows the standard fitting.

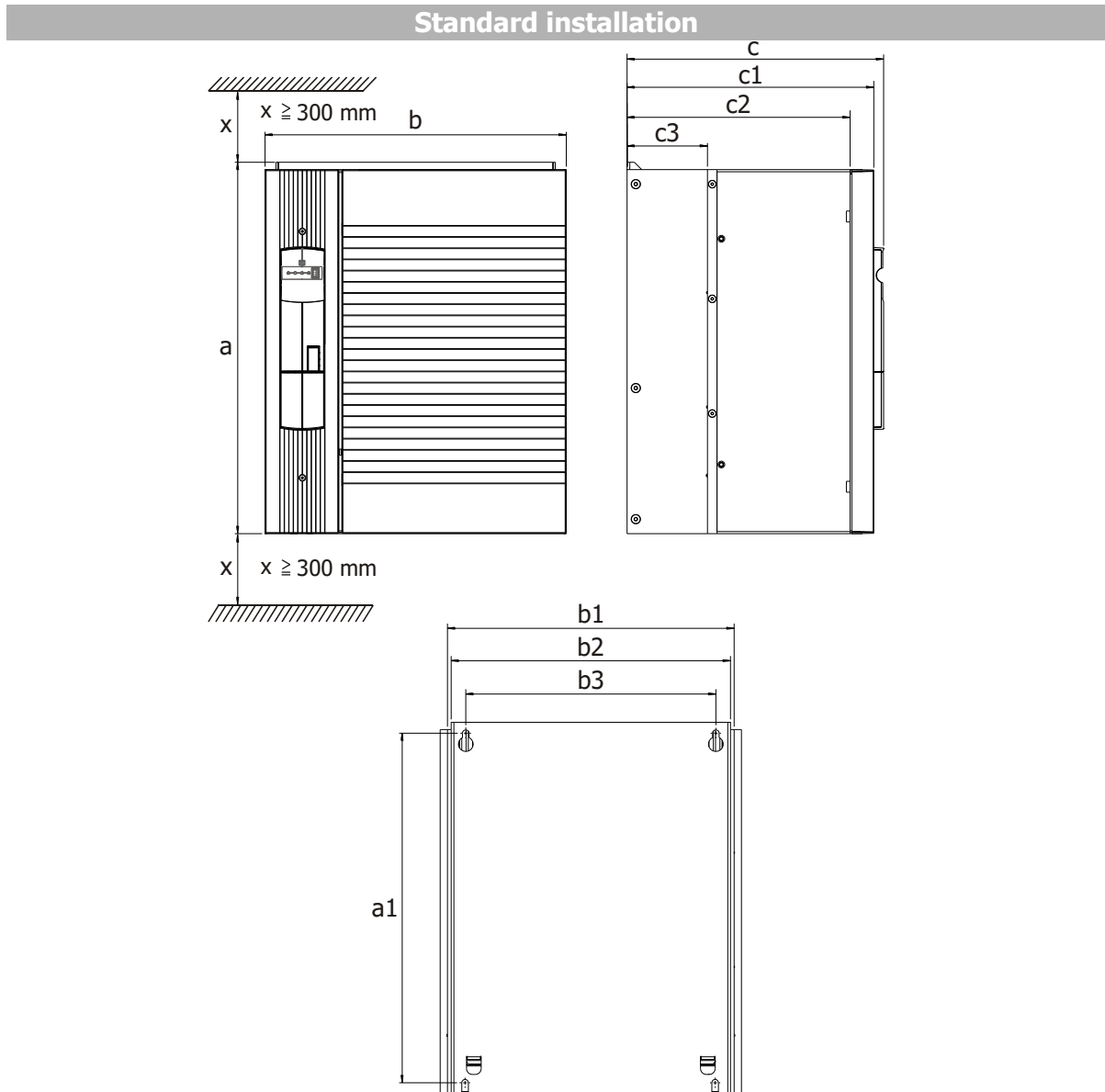

The diameter of the assembly holes is 9 mm.

To assemble, screw the back plate of the frequency inverter to the assembly panel.

The dimensions of the device and the installation dimensions are those of the standard device without optional components and are given in millimeters.

Dimensions in mm			Installation dimensions in mm							
Frequency inverter	a	b	c	a1	b1	b2	b3	c1	c2	c3
75.0 ... 132.0 kW	510	412	351	480	392	382	342	338	305	110

7 Electrical Installation

The electrical installation must be carried out by qualified staff according to the general and regional safety and installation directives. For a safe operation of the frequency inverter, it is necessary that the documentation and the device specifications be complied with during installation and commissioning. In the case of special applications, you may also have to comply with further guidelines and instructions.



WARNING

Dangerous voltage!

When the frequency inverter is disconnected from power supply, the mains, DC-link voltage and motor terminals may still be live for some time. Work at the device may only be started once the DC link capacitors have discharged. The time to wait is at least 3 minutes. The valid waiting period is indicated on the device housing.

- The electrical installation must be carried out by qualified electricians according to the general and regional safety and installation directives.
- The documentation and device specification must be complied with during installation.
- Before any assembly or connection work, discharge the frequency inverter.
- Verify safe isolation from power supply.
- Do not connect inappropriate voltage sources. The nominal voltage of the frequency inverter must correspond to the supply voltage.
- The frequency inverter must be connected to ground potential.
- Do not remove any covers of the frequency inverter while power supply is on.

The connecting cables must be protected externally, considering the maximum voltage and current values of the fuses. The mains fuses and cable cross-sections are to be selected according to EN 60204-1 and DIN VDE 0298 Part 4 for the nominal operating point of the frequency inverter. According to UL/CSA, the frequency inverter is suitable for operation at a supply network of a maximum of 480 VAC which delivers a maximum symmetrical current of 5000 A (effective value) if protected by fuses of class RK5. Only use copper cables with a temperature range of 60/75 °C.



The fuses must be chosen depending on the individual application. The values recommended in the technical data apply for the continuous rated operation without overload.

The frequency inverters are to be grounded properly, i.e. large connection area and with good conductivity. The leakage current of the frequency inverters may be > 3.5 mA. According to EN 50178 a permanent connection must be provided. The protective conductor cross-section required for grounding the fixing plate must be at least 10 mm², or a second protective conductor must be installed electrically parallel to the first one. In these applications, the cross-section must correspond to the recommended cross-section of the wire.



CAUTION

Improperly mounted covers

Malfunction due to ingress of dirt and foreign objects into the housing of the device.

- Take care to mount all covers correctly and properly.
- Insert all terminal connectors and mount all covers before starting operation.
- The frequency inverter complies with IP20 ingress protection rating only if the covers, components and terminals are mounted properly.

Connection conditions

- The frequency inverter is suited for connection to the public or industrial supply mains according to the technical data. If the transformer output of the supply mains is ≤ 500 kVA, the optional mains commutation choke is only necessary for the frequency inverters identified in the technical data. The other frequency inverters are suitable for connection without a mains commutating choke with a relative mains impedance $\geq 1\%$.
- It must be checked, based on the specifications of EN 61000-3-2, if the devices can be connected to the public supply means without taking additional measures. The frequency inverters ≤ 9.2 kW with integrated EMC filter comply with the emission limits of the product standard EN 61800-3 up to a motor cable length of 10 m, without additional measures being required. Increased requirements in connection with the specific application of the frequency inverter are to be met by means of optional components. Commutating chokes and EMC filters are optionally available for the series of devices.
- Operation on unearthed mains (IT mains) is admissible after disconnection of the Y capacitors in the interior of the device.
- Interference-free operation with residual-current device is guaranteed at a tripping current ≥ 30 mA if the following points are observed:
- Pulse-current and alternating-current sensitive residual current devices (Type A to EN 50178) in the case of a connection of frequency inverters with one-phase power supply (L1/N)
- All-current sensitive residual current devices (Type B to EN 50178) in the case of a connection of frequency inverters with two-phase (L1/L2) or three-phase (L1/L2/L3) power supply.
- Use EMC filters with reduced leakage current or, if possible, do not use EMC filters at all.
- The length of the shielded motor cable is ≤ 10 m and there are no additional capacitive components between the mains or motor cables and PE.

NOTICE

Unexpected current

Please note (according to EN 61800-5-1): This product may cause direct current in the protective earth conductor.

- Where residual current devices (RCD) or residual current monitors (RCM) are used as a protection against direct or indirect contact, only RCDs / RCMs of Type B are permissible on the power supply side of this product.
- The fuses to be used are to be selected depending on the specific application. The safety recommendations in the Technical Data are valid for continuous operation without overload.

7.1 EMC Information

The frequency inverters are designed according to the requirements and limit values of product norm EN 61800-3 with an interference immunity factor (EMI) for operation in industrial applications. Electromagnetic interference is to be avoided by expert installation and observation of the specific product information.

Measures

- Install the frequency inverters and commutating chokes on a metal mounting panel. Ideally, the mounting panel should be galvanized.
- Provide proper equipotential bonding within the system or the plant. Plant components such as control cabinets, control panels, machine frames, etc. must be connected by means of PE cables.
- Connect the frequency inverter, the commutating choke, external filters and other components to an earthing point via short cables.
- Keep the cables as short as possible, make sure that cables are installed properly using appropriate cable clamps, etc.
- Contactors, relays and solenoids in the electrical cabinet are to be provided with suitable interference suppression components.

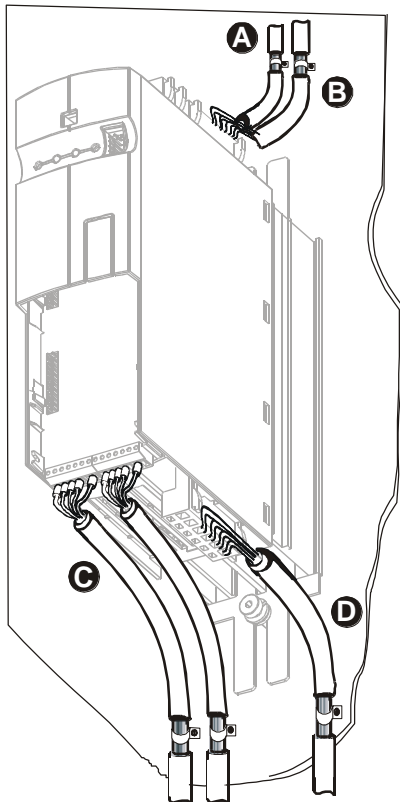

A Mains Connection

The length of the mains supply cable is not limited. However, it must be installed separate from the control, data and motor cables.

B DC link connection

The frequency inverters are to be connected to the same mains potential or a common direct voltage source. Cables longer than 300 mm are to be shielded. The shield must be connected to the mounting panel on both sides.

C Control Connection

The control and signal cables must be kept physically separate from the power cables. The shield of the control cables is to be connected to ground potential properly, i.e., with good conductivity, on both sides. Analog signal lines are to be connected to the shield potential on one side.

D Motor and brake resistor

The shield of the motor cable is to be connected to ground potential properly on both sides. On the motor side use a metal compression gland. On the frequency inverter side an appropriate shield clamp is to be used. The signal cable used for monitoring the motor temperature must be kept separate from the motor cable. Connect the shield of this line on both sides. If a brake resistor is used, the connection cable must also be shielded, and the shield is to be connected to earth potential on both sides.



The frequency inverters meet the requirements of the low voltage directive 2014/35/EU and the requirements of the EMC Directive 2014/30/EU. The EMC product standard EN 61800-3 relates to the drive system. The documentation provides information on how the applicable standards can be complied if the frequency inverter is a component of the drive system. The declaration of conformity is to be issued by the supplier of the drive system.

7.2 Block diagram

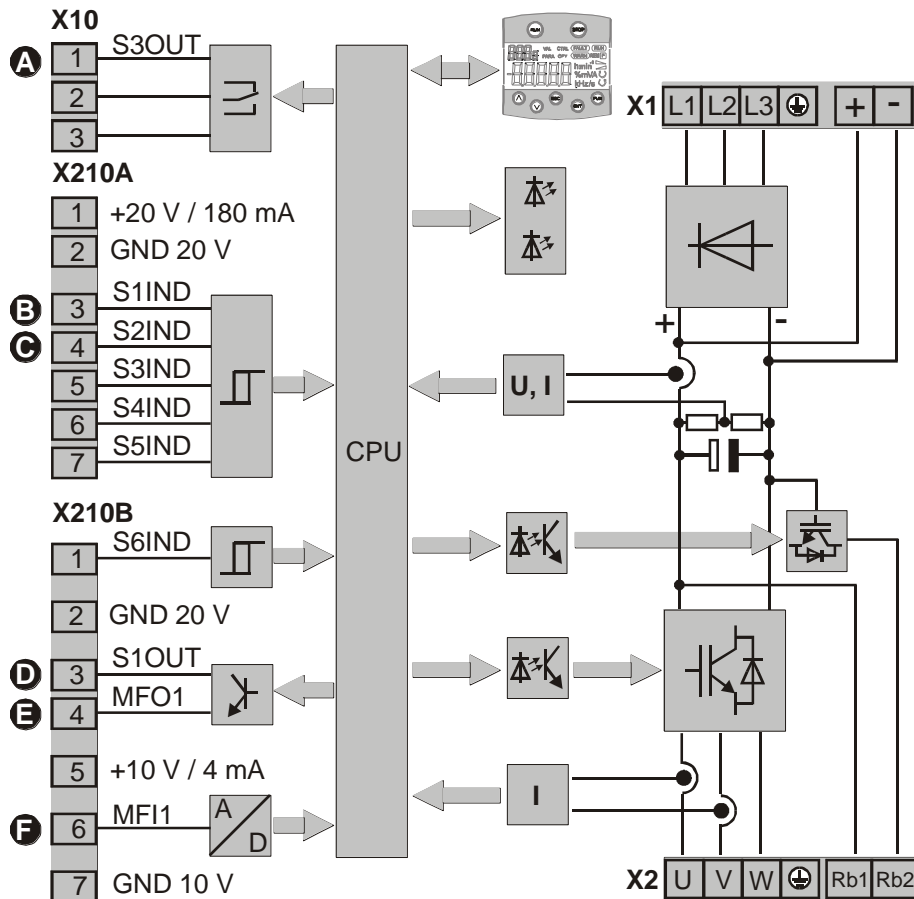

A Relay connection S3OUT

Change-over contact,
response time approx. 40 ms, maximum contact load:

- make contact AC 5 A / 240 V, DC 5 A (ohmic) / 24 V DC
- break contact AC 3 A / 240 V, DC 1 A (ohmic) / 24 V DC

B Digital input S1IND

Digital signal, controller enable signal, response time approx. 16 ms (on), 10 μ s (off),
 U_{max} = DC 30 V, 10 mA at DC 24 V, PLC compatible

C Digital input S2IND ... S6IND

Digital signal: response time approx. 16 ms, U_{max} = DC 30 V, 10 mA at DC 24 V, PLC compatible, fre-
quency signal: DC 0...30 V, 10 mA at DC 24 V, f_{max} = 150 kHz

D Digital output S1OUT

Digital signal, DC 24 V, I_{max} = 40 mA,
PLC compatible, overload and short-circuit proof

E Multi-function output MFO1

Analog signal: DC 24 V, I_{max} = 40 mA, pulse-width modulated, f_{PWM} = 116 Hz

Digital signal: DC 24 V, I_{max} = 40 mA,
frequency signal: DC 0...24 V, I_{max} = 40 mA, f_{max} = 150 kHz,
PLC compatible, overload and short-circuit proof

F Multi-function input MFI1

Analog signal: resolution 12 Bit, DC 0...10 V (R_i = 70 k Ω), 0...20 mA (R_i = 500 Ω),
digital signal: response time approx. 16 ms, U_{max} = DC 30 V, 4 mA at DC 24 V,
PLC compatible

7.3 Optional Components

The optional modules are recognized during the initialization and the controller functionality is adjusted automatically. For the information required for installation and handling of the optional modules, refer to the corresponding documentation.

WARNING



Dangerous voltage!

When the frequency inverter is disconnected from power supply, the mains, DC-link voltage and motor terminals may still be live for some time. Work at the device may only be started once the DC link capacitors have discharged. The time to wait is at least 3 minutes. The valid waiting period is indicated on the device housing.

- The electrical installation must be carried out by qualified electricians according to the general and regional safety and installation directives.
- The documentation and device specification must be complied with during installation.
- Before any assembly or connection work, discharge the frequency inverter.
- Verify safe isolation from power supply.

NOTICE

Deactivation of system bus interface in the EM extension module!

If two optional components with CAN-Protocol controller are installed, the system bus interface in the EM extension module is deactivated!

Hardware modules

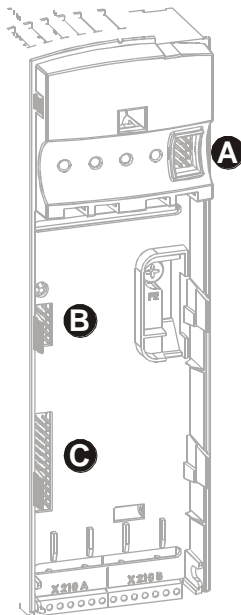

A Control Unit KP500

Connection of the optional control unit KP500 or an interface adapter KP232.

B Communication module CM

Plug-in section for connection to various communication protocols:

- CM-232: RS232 interface
- CM-485: RS485 interface
- CM-PDP: Profibus-DP interface
- CM-CAN: CANopen interface

C Expansion module EM

Slot for customer-specific adaptation of the control inputs and outputs to various applications:

- EM-ENC: extended speed sensor evaluation
- EM-RES: resolver evaluation
- EM-IO: analog and digital inputs and outputs
- EM-SYS: system-bus
(system bus in combination with CM-CAN communication module upon request)

7.4 Connection of the device

7.4.1 Dimensioning of the conductor cross section

Dimension the wire according to the electrical load and applied voltage. Use a suitable conductor cross section to reduce the voltage drop at the wire. The motor cannot obtain the full torque if the voltage drop at the wire is too high. Comply to the country-specific and application-specific regulations and to the UL-Notes. Suitable fuse protection values for the mains connection are listed in the chapter 5 "Technical Data".

Dimension the conductor cross section of the protective conductor (PE) according to EN 61800-5-1:

Mains cable cross section	Protective conductor (PE)
Up to 10 mm ²	Install two protective conductors with the same conductor cross section as for the mains cable or 10 mm ² conductor cross section.
10...16 mm ²	Install a protective conductor with the same conductor cross section as for the mains cable.
16...35 mm ²	Install a protective conductor with 16 mm ² conductor cross section.
> 35 mm ²	Install a protective conductor with the half cross section of the mains cable cross section.

Typical conductor cross sections

The following tables give an overview with typical conductor cross sections (copper cable with PVC insulation, 30 °C ambient temperature, continuous mains current maximum 100% of rated mains current). Depending on the operation conditions other conductor cross sections may be applicable.

230 V: one-phase (L/N) and two-phase (L1/L2) connection

ACT210		Mains cable	PE-conductor	Motor cable
-05	0.55 kW	1.5 mm ²	2x1.5 mm ² or 1x10 mm ²	1.5 mm ²
-07	0.75 kW			
-09	1.1 kW			
-11	1.5	2.5 mm ²	2x2.5 mm ² or 1x10 mm ²	1.5 mm ²
-13	2.2 kW			
-15	3 kW			
-18	4 kW	4 mm ²	2x4 mm ² or 1x10 mm ²	4 mm ²

230 V: three-phase connection (L1/L2/L3)

ACT210		Mains cable	PE-conductor	Motor cable
-05	0.55 kW	1.5 mm ²	2x1.5 mm ² or 1x10 mm ²	1.5 mm ²
-07	0.75 kW			
-09	1.1 kW			
-11	1.5 kW			
-13	2.2 kW			
-15	3 kW	4 mm ²	2x4 mm ² or 1x10 mm ²	4 mm ²
-18	4 kW			
-19	5.5 kW			
-21	7.5 kW	6 mm ²	2x 6 mm ² or 1x10 mm ²	6 mm ²
-22	9.2 kW	10 mm ²	1x10 mm ²	10 mm ²

400 V: three-phase connection (L1/L2/L3)

ACT410		Mains cable	PE-conductor	Motor cable
-05	0.55 kW	1.5 mm ²	2x1.5 mm ² or 1x10 mm ²	1.5 mm ²
-07	0.75 kW			
-09	1.1 kW			
-11	1.5 kW			
-12	1.85 kW			
-13	2.2 kW			
-15	3 kW			
-18	4 kW			

ACT410		Mains cable	PE-conductor	Motor cable
-19	5.5 kW	2.5 mm ²	2x2.5 mm ² or 1x10 mm ²	2.5 mm ²
-21	7.5 kW			
-22	9.2 kW	4 mm ²	2x4 mm ² or 1x10 mm ²	4 mm ²
-23	11 kW			
-25	15 kW	6 mm ²	2x6 mm ² or 1x10 mm ²	6 mm ²
-27	18.5 kW	10 mm ²	1x10 mm ²	10 mm ²
-29	22 kW			
-31	30 kW	16 mm ²	1x16 mm ²	16 mm ²
-33	37 kW	25 mm ²	1x16 mm ²	25 mm ²
-35	45 kW	35 mm ²	1x16 mm ²	35 mm ²
-37	55 kW			
-39	65 kW	50 mm ²	1x25 mm ²	50 mm ²
-43	75 kW	70 mm ²	1x35 mm ²	70 mm ²
-45	90 kW	95 mm ²	1x50 mm ²	95 mm ²
-47	110 kW	2x70 mm ²	1x70 mm ²	2x70 mm ²
-49	132 kW	2x95 mm ²	1x95 mm ²	2x95 mm ²

7.4.2 Mains Connection

WARNING



Dangerous voltage!

When the frequency inverter is disconnected from power supply, the mains, DC-link voltage and motor terminals may still be live for some time. Work at the device may only be started once the DC link capacitors have discharged. The time to wait is at least 3 minutes. The valid waiting period is indicated on the device housing.

- The electrical installation must be carried out by qualified electricians according to the general and regional safety and installation directives.
- The documentation and device specification must be complied with during installation.
- Before any assembly or connection work, discharge the frequency inverter.
- Verify safe isolation from power supply.
- Do not connect inappropriate voltage sources. The nominal voltage of the frequency inverter must correspond to the supply voltage.
- The frequency inverter must be connected to ground potential.
- Do not remove any covers of the frequency inverter while power supply is on.

CAUTION



Device damage possible!

Routing the lines inappropriately may lead to device damage.

- The control, mains and motor lines must be kept physically separate from one another.
- The cables connected to the frequency inverters may not be subjected to high-voltage insulation tests unless appropriate circuitry measures are taken before.
- The mains fuses and cable cross-sections are to be selected according to EN 602041 and DIN VDE 0298 Part 4 for the nominal operating point of the frequency inverter.
- According to UL/CSA, approved Class 1 copper lines with a temperature range of 60/75 °C and matching mains fuses are to be used for the power cables.
- The electrical installation is to be done according to the device specifications and the applicable standards and directives.

7.4.3 Motor connection



WARNING

Dangerous voltage!

When the frequency inverter is disconnected from power supply, the mains, DC-link voltage and motor terminals may still be live for some time. Work at the device may only be started once the DC link capacitors have discharged. The time to wait is at least 3 minutes. The valid waiting period is indicated on the device housing.

- The electrical installation must be carried out by qualified electricians according to the general and regional safety and installation directives.
- The documentation and device specification must be complied with during installation.
- Before any assembly or connection work, discharge the frequency inverter.
- Verify safe isolation from power supply.
- Do not connect inappropriate voltage sources. The nominal voltage of the frequency inverter must correspond to the supply voltage.
- The frequency inverter must be connected to ground potential.
- Do not remove any covers of the frequency inverter while power supply is on.



CAUTION

Device damage possible!

Routing the lines inappropriately may lead to device damage.

- The control, mains and motor lines must be kept physically separate from one another.
- The cables connected to the frequency inverters may not be subjected to high-voltage insulation tests unless appropriate circuitry measures are taken before.



Bonfiglioli recommends using shielded cables for the connection of the motor and the braking resistor to the frequency inverter. The shield is to be connected to PE potential properly, i.e., with good conductivity, on both sides. The control, mains and motor lines must be kept physically separate from one another.

- Comply with the applicable limits stipulated in the relevant national and international directives as regards the application, the length of the motor cable and the switching frequency.

7.4.3.1 Motor cable length, without filter

Permissible length of motor cable without output filter		
Frequency inverter	unshielded cable	shielded cable
0.55 kW ... 1.5 kW	50 m	25 m
1.85 kW ... 4.0 kW	100 m	50 m
5.5 kW ... 9.2 kW	100 m	50 m
11.0 kW ... 15.0 kW	100 m	50 m
18.5 kW ... 30.0 kW	150 m	100 m
37.0 kW ... 65.0 kW	150 m	100 m
75.0 kW ... 132.0 kW	150 m	100 m

The specified lengths of the motor cables must not be exceeded if no output filter is installed.



The frequency inverters ≤ 9.2 kW with integrated EMC filter comply with the emission limits stipulated in EN 61800-3 if the motor cable is no longer than 10 m. The frequency inverters ≤ 9.2 kW of the construction size 3 with integrated EMC filter comply with the emission limits stipulated in EN 61800-3 if the motor cable is no longer than 20 m. Customer-specific requirements can be met by means of an optional filter.

7.4.3.2 Motor cable length, with output filter dU/dt

Longer motor cables can be used after taking appropriate technical measures, e.g. use of low-capacitance cables and output filters. The following table includes standard values if an output filter is used.

Permissible length of motor cable with output filter		
Frequency inverter	unshielded cable	shielded cable
0.55 kW ... 1.5 kW	on inquiry	on inquiry
1.85 kW ... 4.0 kW	150 m	100 m
5.5 kW ... 9.2 kW	200 m	135 m
11.0 kW ... 15.0 kW	225 m	150 m
18.5 kW ... 30.0 kW	300 m	200 m
37.0 kW ... 65.0 kW	300 m	200 m
75.0 kW ... 132.0 kW	300 m	200 m

7.4.3.3 Motor cable length, with sine filter

Longer motor cables can be used if sine filters are installed. The high-frequency current components will be filtered out which results in smoothed current and allows longer motor cables. Take the voltage drop at the wire and the sine filter into account. The voltage drop causes an increase of the output current. Verify that the increased output current can be achieved by the frequency inverter. Consider this for the engineering.

If the motor cable is longer than 300 m, please contact the Bonfiglioli service.

7.4.3.4 Group drive

For a group drive (several motors at one frequency inverter) the total length must be shared in the number of motors according to the table values. A group drive with synchronous servomotors is not possible.

Use a thermocouple for monitoring (for example PTC resistor) at each motor to avoid damage.

7.4.3.5 Speed sensor connection

Install the speed sensor lines physically separate from the motor cables. Comply with the manufacturer's data of the speed sensor.

Install the shielding near to the frequency inverter and keep the speed sensor lines as short as possible.

7.4.4 Connection of a Brake Resistor

WARNING



Dangerous voltage!

When the frequency inverter is disconnected from power supply, the mains, DC-link voltage and motor terminals may still be live for some time. Work at the device may only be started once the DC link capacitors have discharged. The time to wait is at least 3 minutes. The valid waiting period is indicated on the device housing.

- The electrical installation must be carried out by qualified electricians according to the general and regional safety and installation directives.
- The documentation and device specification must be complied with during installation.
- Before any assembly or connection work, discharge the frequency inverter.
- Verify safe isolation from power supply.
- Do not connect inappropriate voltage sources. The nominal voltage of the frequency inverter must correspond to the supply voltage.
- The frequency inverter must be connected to ground potential.
- Do not remove any covers of the frequency inverter while power supply is on.

WARNING



Hot surface

The surface of the braking resistor may reach a high temperature during operation and may remain hot for some time after operation.

- Do not touch the braking resistor while the frequency inverter is in operation or ready for operation. Non-compliance may result in burns.
- Install a safeguard to prevent touching or provide a warning sign.
- Do not install the braking resistor near inflammable or heat-sensitive materials.
- Do not cover the braking resistor.



Bonfiglioli recommends using a temperature switch. Depending on the resistor selected, the temperature switch is integrated as a standard or available as an option. The temperature switch disconnects the frequency inverter from mains supply if the braking resistor is overloaded.

Using braking resistors without temperature switches may result in critical situations.

The connection of a brake resistor is done via terminal **X2**.

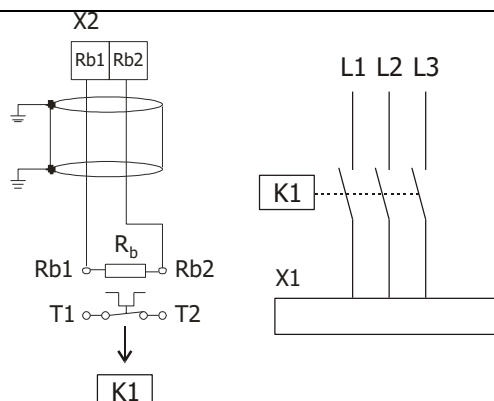

- Limit the length of the braking resistor cables to the necessary minimum.

7.5 Connection of the construction sizes

7.5.1 ACT210 (up to 3.0 kW) and ACT410 (up to 4.0 kW)

Frequency inverters are connected to mains via plug-in terminal X1. The motor and braking resistor are connected to the frequency inverter via plug-in terminal X2. IP20 ingress protection rating (EN60529) is only guaranteed with the terminals plugged.

WARNING



Dangerous voltage!

When the frequency inverter is disconnected from power supply, the mains, DC-link voltage and motor terminals may still be live for some time. Work at the device may only be started once the DC link capacitors have discharged. The time to wait is at least 3 minutes. The valid waiting period is indicated on the device housing.

- The electrical installation must be carried out by qualified electricians according to the general and regional safety and installation directives.
- The documentation and device specification must be complied with during installation.
- Before any assembly or connection work, discharge the frequency inverter.
- Verify safe isolation from power supply.

Mains power connection ACT210 (up to 3.0 kW) and ACT410 (up to 4.0 kW)

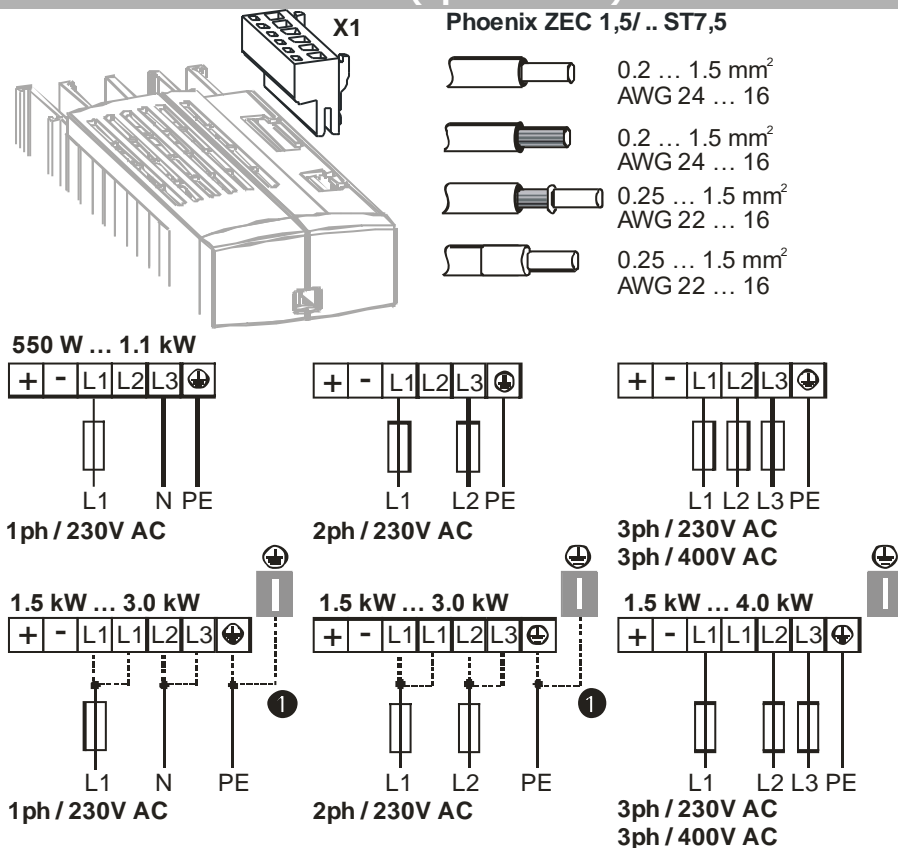

- ① With a mains current above 10 A, the mains power connection 230 V 1ph/N/PE and the mains power connection 230 V 2ph/N/PE are to be done on two terminals.

Motor power connection ACT210 (up to 3.0 kW) and ACT410 (up to 4.0 kW)

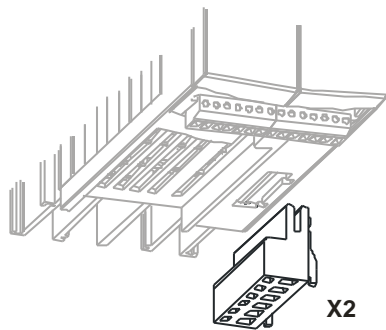

Phoenix ZEC 1,5/ .. ST7,5

- 0.2 ... 1.5 mm²
AWG 24 ... 16
- 0.2 ... 1.5 mm²
AWG 24 ... 16
- 0.25 ... 1.5 mm²
AWG 22 ... 16
- 0.25 ... 1.5 mm²
AWG 22 ... 16

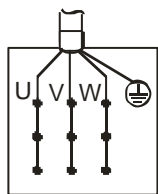

Delta connection

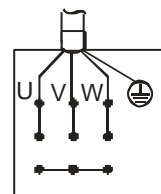

Star connection

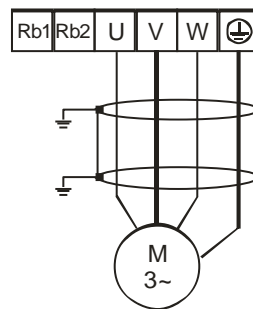

Connection of brake resistor with temperature switch

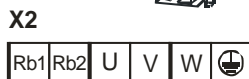
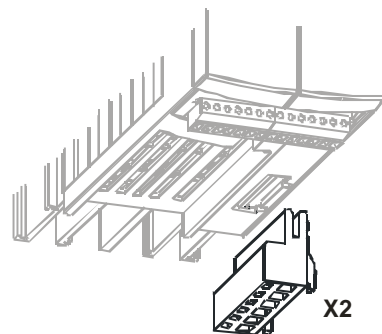

Phoenix ZEC 1,5/ .. ST7,5

- 0.2 ... 1.5 mm²
AWG 24 ... 16
- 0.2 ... 1.5 mm²
AWG 24 ... 16
- 0.25 ... 1.5 mm²
AWG 22 ... 16
- 0.25 ... 1.5 mm²
AWG 22 ... 16

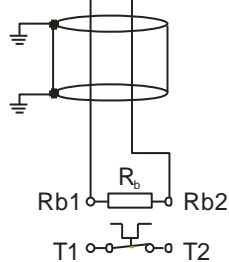

7.5.2 ACT210 (4.0 up to 9.2 kW) and ACT410 (5.5 up to 15.0 kW)

Frequency inverters are connected to mains via terminal X1. The motor and braking resistor are connected to the frequency inverter via terminal X2.

WARNING



Dangerous voltage!

When the frequency inverter is disconnected from power supply, the mains, DC-link voltage and motor terminals may still be live for some time. Work at the device may only be started once the DC link capacitors have discharged. The time to wait is at least 3 minutes. The valid waiting period is indicated on the device housing.

- The electrical installation must be carried out by qualified electricians according to the general and regional safety and installation directives.
- The documentation and device specification must be complied with during installation.
- Before any assembly or connection work, discharge the frequency inverter.
- Verify safe isolation from power supply.

Mains power connection ACT210 (4.0 up to 9.2 kW) and ACT410 (5.5 up to 15.0 kW)

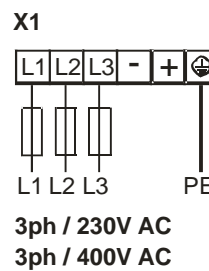
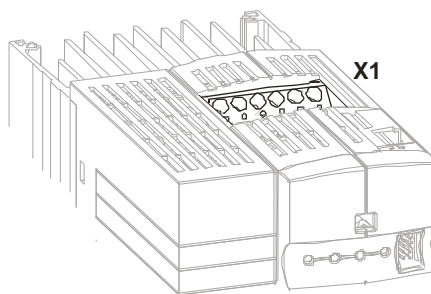

ACT 201-18 (4.0 kW):

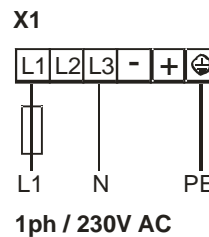

4.0 kW & 9.2 kW
6qmm / RM7,5

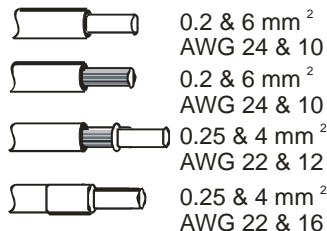

11 kW & 15 kW
16qmm / RM10+15

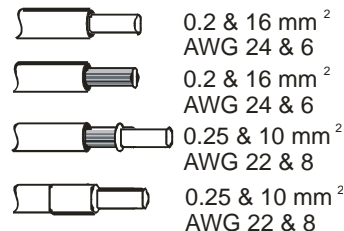

ACT210-18 (4.0 kW): one- and three-phase connection is possible.

ACT210-19 (5.5 kW) and above: three-phase connection is possible

Motor power connection ACT210 (4.0 up to 9.2 kW) and ACT410 (5.5 up to 15.0 kW)

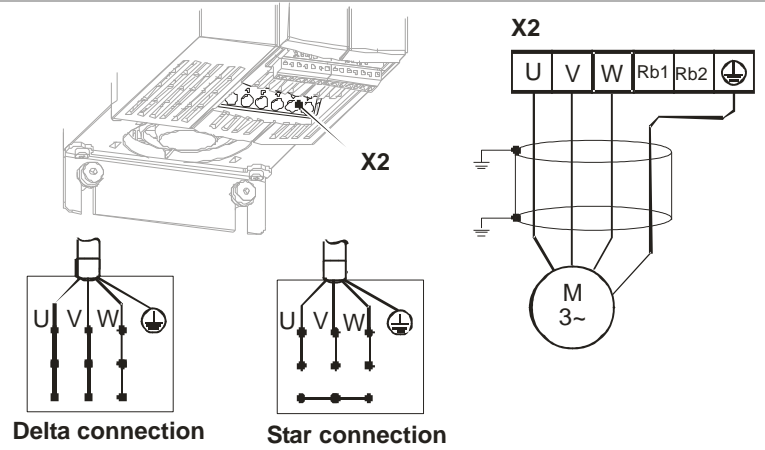

4.0 kW ... 9.2 kW
6qmm / RM7,5

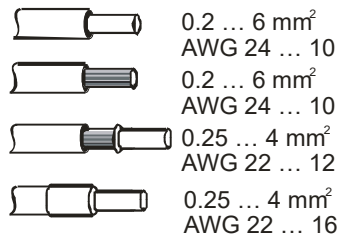

11.0 kW ... 15.0 kW
16qmm / RM10+15

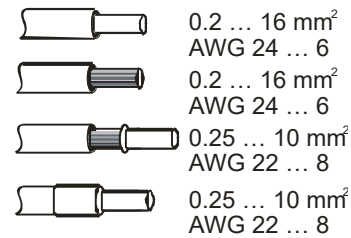

Connection of brake resistor with temperature switch

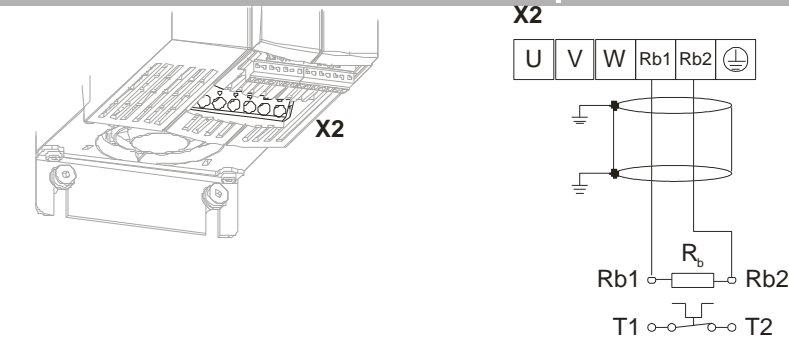

4.0 kW ... 9.2 kW
6qmm / RM7,5

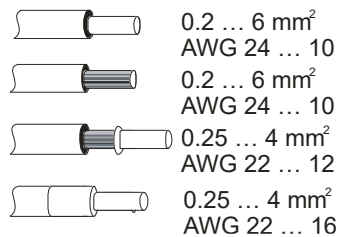

11.0 kW ... 15.0 kW
16qmm / RM10+15

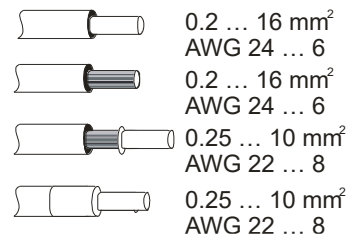

7.5.3 ACT410 (18.5 up to 30.0 kW)

Frequency inverters are connected to mains via terminal X1. The motor and braking resistor are connected to the frequency inverter via terminal X2.

WARNING



Dangerous voltage!

When the frequency inverter is disconnected from power supply, the mains, DC-link voltage and motor terminals may still be live for some time. Work at the device may only be started once the DC link capacitors have discharged. The time to wait is at least 3 minutes. The valid waiting period is indicated on the device housing.

- The electrical installation must be carried out by qualified electricians according to the general and regional safety and installation directives.
- The documentation and device specification must be complied with during installation.
- Before any assembly or connection work, discharge the frequency inverter.
- Verify safe isolation from power supply.

Mains power connection ACT410 (18.5 up to 30.0 kW)

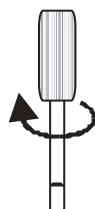
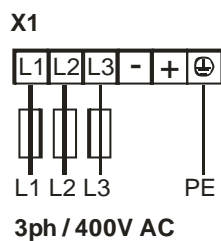
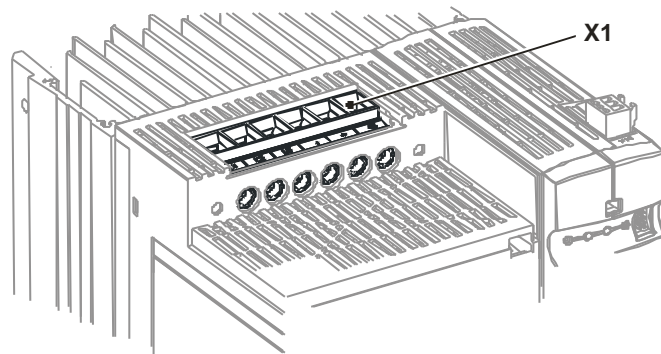

2.5 Nm
22.1 lb-in

18.5 kW ... 30.0 kW PHOENIX MKDSP 25/ 6-15,00-F

	0.5 ... 35 mm ² AWG 20 ... 2
	0.5 ... 25 mm ² AWG 20 ... 4
	1.00 ... 25 mm ² AWG 18 ... 4
	1.5 ... 25 mm ² AWG 16 ... 4

Motor power connection ACT410 (18.5 up to 30.0 kW)

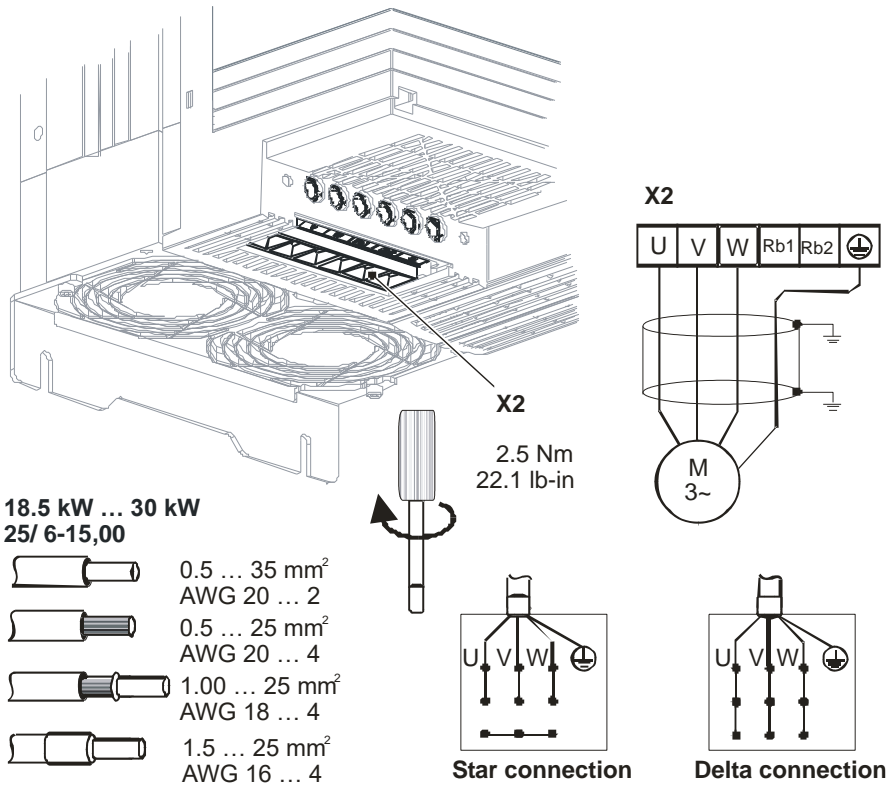

Connection of brake resistor with temperature switch

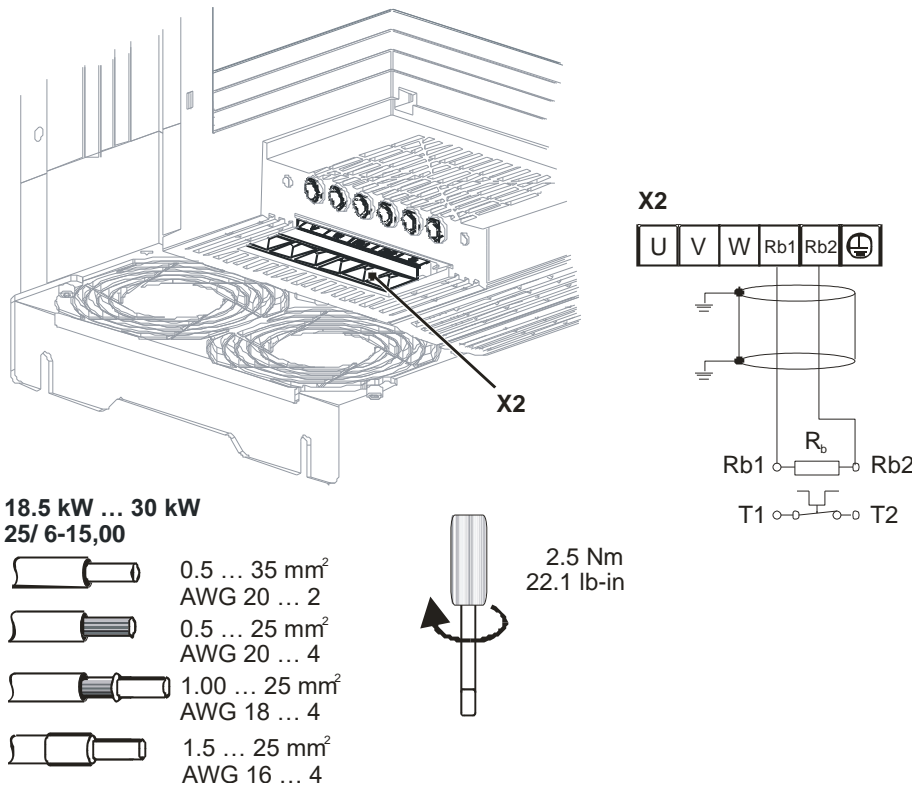

7.5.4 ACT410 (37.0 up to 65.0 kW)

WARNING



Dangerous voltage!

When the frequency inverter is disconnected from power supply, the mains, DC-link voltage and motor terminals may still be live for some time. Work at the device may only be started once the DC link capacitors have discharged. The time to wait is at least 3 minutes. The valid waiting period is indicated on the device housing.

- The electrical installation must be carried out by qualified electricians according to the general and regional safety and installation directives.
- The documentation and device specification must be complied with during installation.
- Before any assembly or connection work, discharge the frequency inverter.
- Verify safe isolation from power supply.

Mains power connection ACT410 (37.0 up to 65.0 kW)

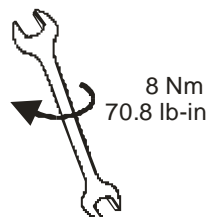
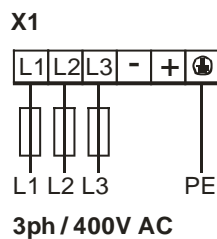
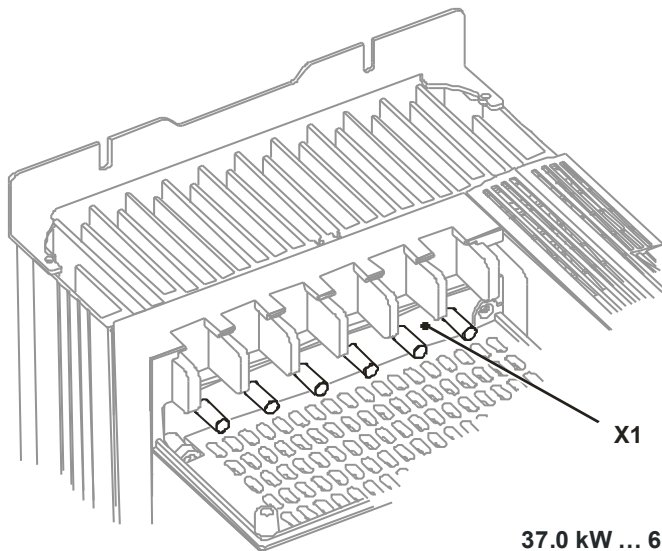

37.0 kW ... 65.0 kW
threaded bolt M8x25
wire cross section up to 70 mm²

Motor power connection ACT410 (37.0 up to 65.0 kW)

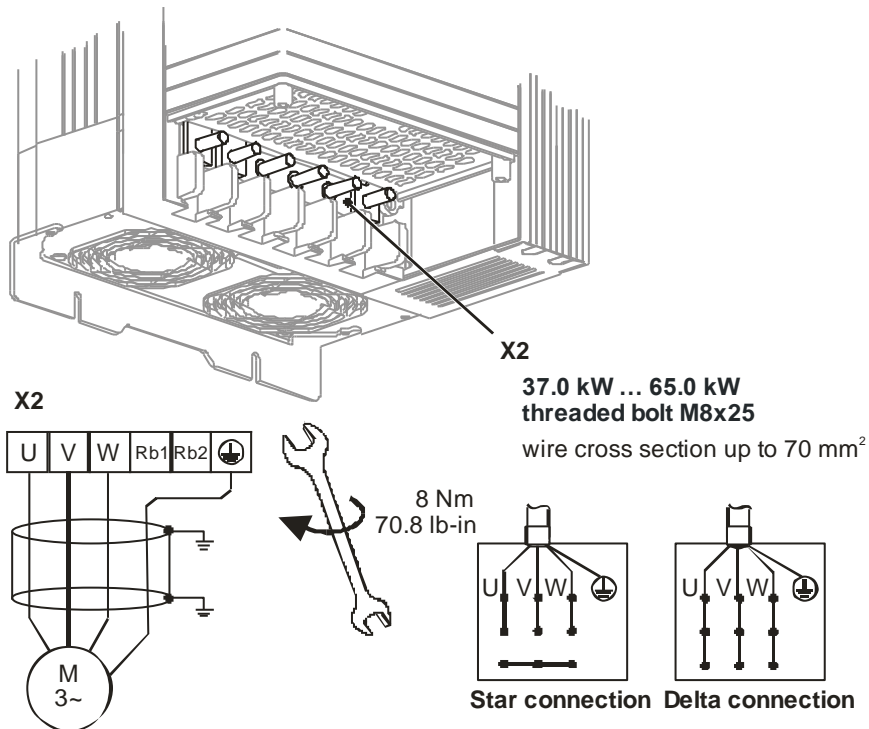

Connection of brake resistor with temperature switch

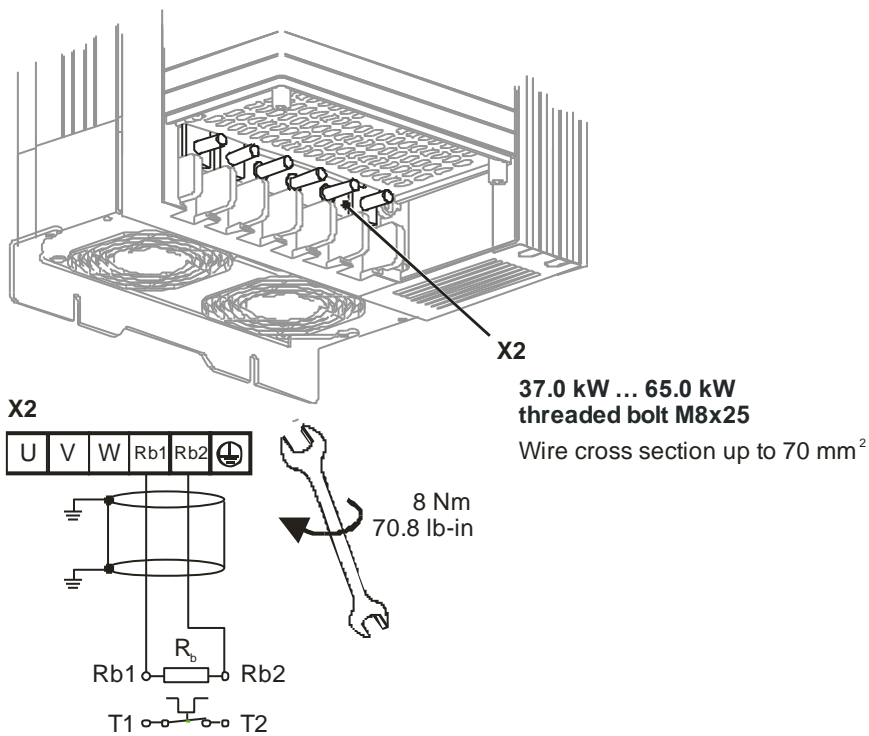

Optionally, devices of this size are available without brake chopper. These devices are designed without connecting terminals for the braking resistor.

7.5.5 ACT410 (75.0 up to 132.0 kW)

WARNING



Dangerous voltage!

When the frequency inverter is disconnected from power supply, the mains, DC-link voltage and motor terminals may still be live for some time. Work at the device may only be started once the DC link capacitors have discharged. The time to wait is at least 3 minutes. The valid waiting period is indicated on the device housing.

- The electrical installation must be carried out by qualified electricians according to the general and regional safety and installation directives.
- The documentation and device specification must be complied with during installation.
- Before any assembly or connection work, discharge the frequency inverter.
- Verify safe isolation from power supply.

Mains power connection ACT410 (75.0 up to 132.0 kW)

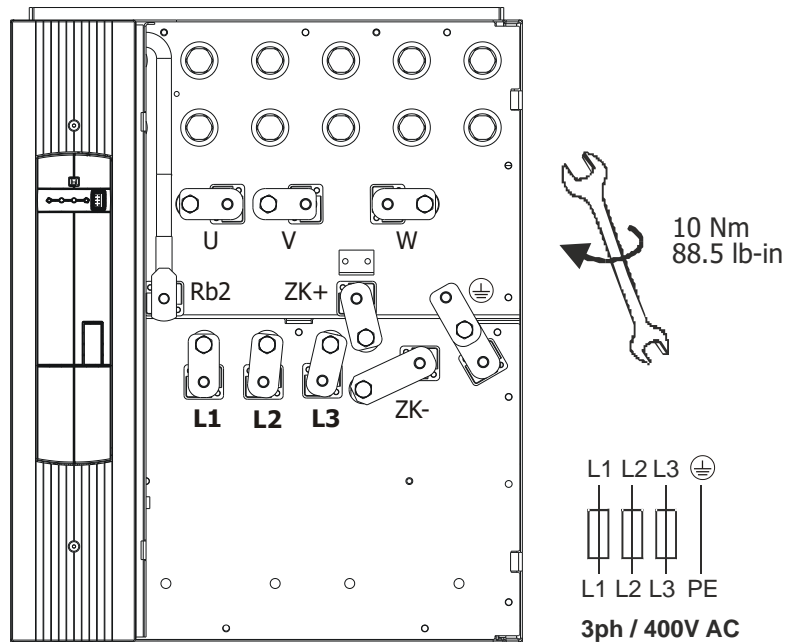

Threaded bolt M8x20

Motor power connection ACT410 (75.0 up to 132.0 kW)

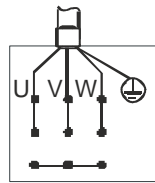
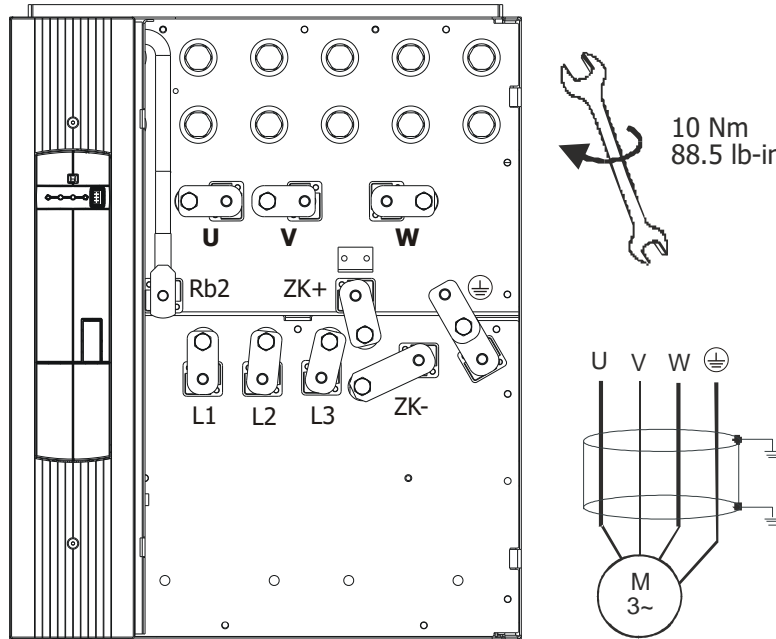

Star connection

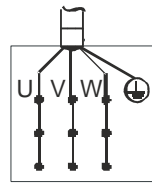

Delta connection

Threaded bolt M8x20

Connection of brake resistor with temperature switch

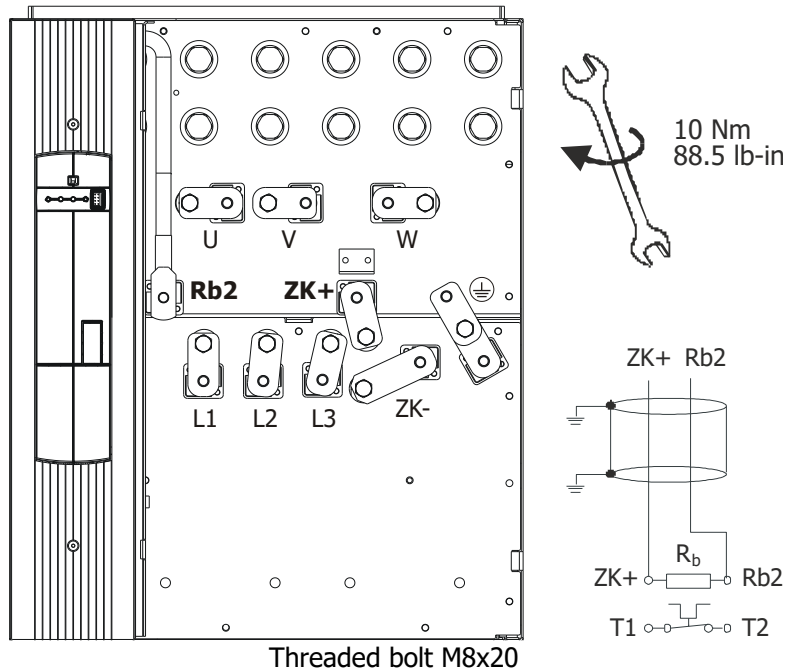

Threaded bolt M8x20



Optionally, devices of this size are available without brake chopper. These devices are designed without connecting terminals for the braking resistor.

7.6 Control terminals



CAUTION

Live voltage

The control terminals may be energized.

- Connect the unit only with the power supply switched off.
- Verify safe isolation from power supply.
- Switch off power supply before connecting or disconnecting the control inputs and outputs. Otherwise, components may be damaged.

The control and software functionality is freely configurable to ensure a reliable and economical operation. The operating instructions describe the factory settings of the standard connections in the relevant *Configuration 30* as well as the software parameters to be set up.

Control Terminals

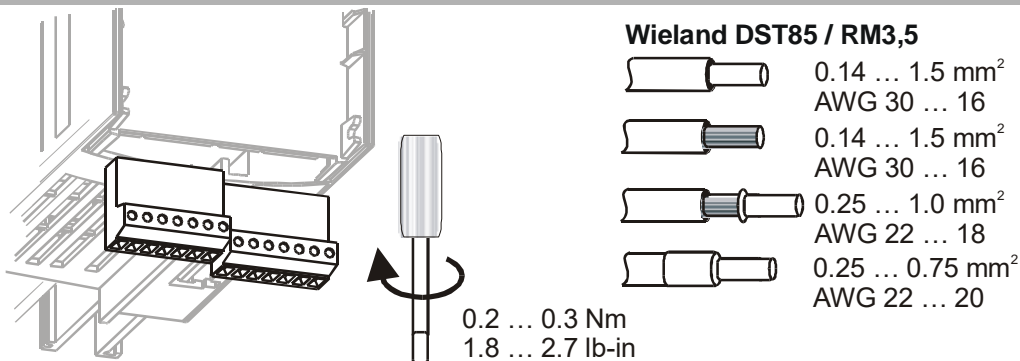

Control terminal X210A

Ter.	Description
1	Voltage output 20 V, $I_{\max}=180$ mA 1)
2	Ground / GND 20 V
3	Digital input S1IND, $U_{\max}=$ DC 30 V, 10 mA at DC 24 V, PLC compatible, response time approx. 16ms (on), 10 μ s (off)
4	Digital input EM-S2IND, $U_{\max}=$ DC 30 V, 10 mA at DC 24 V, PLC compatible, response time approx. 16 ms
5	Digital input EM-S3IND, $U_{\max}=$ DC 30 V, 10 mA at DC 24 V, PLC compatible, response time approx. 16 ms
6	Digital input S4IND, $U_{\max}=$ DC 30 V, 10 mA at DC 24 V, PLC compatible, frequency signal: 0...30 V, 10 mA at 24 V, $f_{\max}=$ 150 kHz
7	Digital input S5IND, $U_{\max}=$ DC 30 V, 10 mA at DC 24 V, PLC compatible, frequency signal: 0...30 V, 10 mA at 24 V, $f_{\max}=$ 150 kHz

Control terminal X210B

Ter.	Description
1	Digital input S6IND, $U_{max}=30\text{ V}$, 10 mA at 24 V, PLC compatible, response time approx. 16 ms
2	Ground / GND 20 V
3	Digital output S1OUT, $U= DC\ 24\text{ V}$, $I_{max}=40\text{ mA}$, overload and short-circuit proof
4	Multi-function output MFO1, analog signal: $U= DC\ 24\text{ V}$, $I_{max}=40\text{ mA}$, pulse-width modulated, $f_{PWM}=116\text{ Hz}$ digital signal: $U= DC\ 24\text{ V}$, $I_{max}=40\text{ mA}$, overload and short-circuit proof, frequency signal: $DC\ 0...24\text{ V}$, $I_{max}=40\text{ mA}$, $f_{max}=150\text{ kHz}$
5	Reference output DC 10 V, $I_{max}=4\text{ mA}$
6	Multi-function input MF11, analog signal: resolution 12 Bit, DC 0... 10 V ($R_i=70\text{ k}\Omega$), 0...20 mA ($R_i=500\ \Omega$), digital signal: response time approx. 16 ms, $U_{max}= DC\ 30\text{ V}$, 4 mA at DC 24 V, PLC compatible
7	Ground / GND 10 V

1)The power supply at terminal X210A.1 may be loaded with a maximum current of $I_{max} = 180\text{ mA}$. The maximum current available is reduced by the digital output S1OUT and multifunctional output MFO1.

7.6.1 Relay Output

By default, the freely programmable relay output is linked to the monitoring function (factory setting). The logic link to various functions can be freely configured via the software parameters. Connection of the relay output is not absolutely necessary for the function of the frequency inverter.

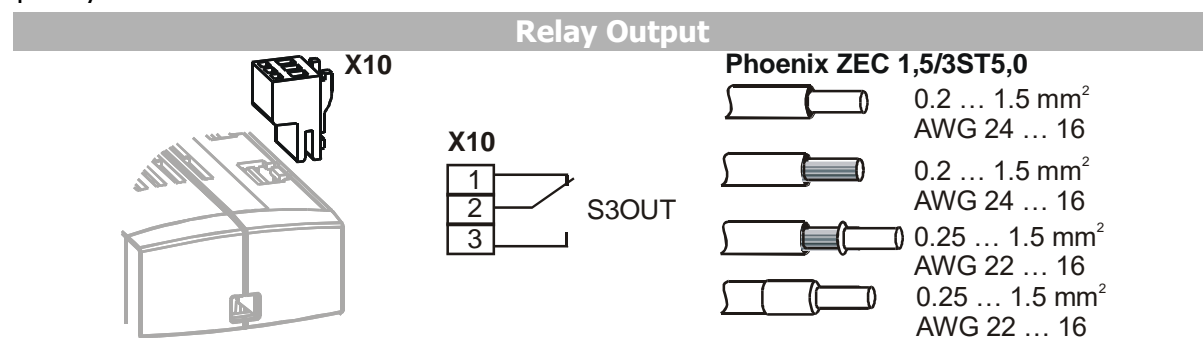

Control terminal X10

Ter.	Description
1 ... 3	Relay output, floating change-over contact, response time approx. 40 ms, max. contact load, make contact AC 5 A / 240 V, DC 5 A (ohmic) / 24 V max. contact load, break contact AC 3 A / 240 V, DC 1 A (ohmic) / 24 V

7.6.2 Control Terminals – Terminal Diagram

The control hardware and the software of the frequency inverter are freely configurable to a great extent. Certain functions can be assigned to the control terminals, and the internal logic of the software modules can be freely selected.

Thanks to the modular design, the frequency inverter can be adapted to a great range of different driving tasks.

The demands made of the control hardware and software are well known in the case of standard driving tasks. This control terminal logic and internal function assignments of the software modules are available in standard configurations. These assignments can be selected via parameter *Configuration* **30**. For information on other configurations, please contact us.

7.6.2.1 Configuration 110 – Sensorless Control

Configuration 110 contains the functions for variable-speed control of a 3-phase machine in a wide range of standard applications. The motor speed is set according to the selected ratio of the reference frequency to the necessary voltage.

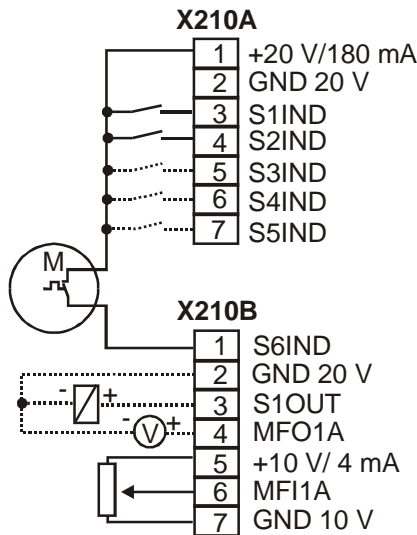

Control terminal X210A	
X210A.1	Supply voltage +20 V
X210A.2	Ground 20 V
X210A.3	Controller release / error acknowledgment
X210A.4	Start of clockwise operation
X210A.5	Start of anticlockwise operation
X210A.6	Data set change-over 1
X210A.7	Data set change-over 2

Control terminal X210B	
X210B.1	Motor thermal contact
X210B.2	Ground 20 V
X210B.3	Operating message
X210B.4	Analog signal of actual frequency
X210B.5	Supply voltage +10 V Reference value potentiometer
X210B.6	Reference speed 0 ...+10 V
X210B.7	Ground 10 V

7.6.2.2 Configuration 111 – Sensorless Control with Technology Controller

Configuration 111 extends the functionality of the sensorless control by software functions for easier adaptation to the customer's requirements in different applications. The Technology Controller enables flow rate, pressure, level or speed control.

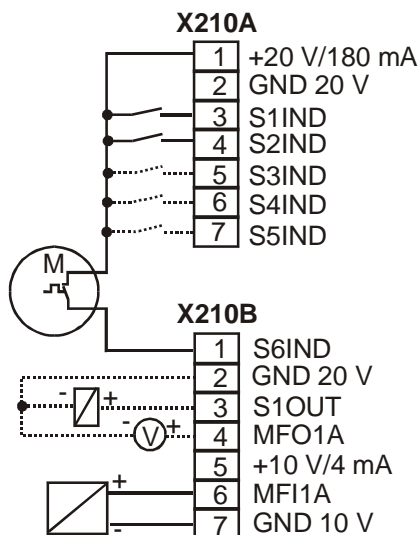

Control terminal X210A	
X210A.1	Supply voltage +20 V
X210A.2	Ground 20 V
X210A.3	Controller release / error acknowledgment
X210A.4	Fixed percentage value change-over 1
X210A.5	Fixed percentage value change-over 2
X210A.6	Data set change-over 1
X210A.7	Data set change-over 2

Control terminal X210B	
X210B.1	Motor thermal contact
X210B.2	Ground 20 V
X210B.3	Operating message
X210B.4	Analog signal of actual frequency
X210B.5	Supply voltage +10 V
X210B.6	Actual percentage value 0 ...+10 V
X210B.7	Ground 10 V

7.6.2.3 Configuration 410 – Sensorless Field-Oriented Control

Configuration 410 contains the functions for sensorless, field-oriented control of a 3-phase machine. The current motor speed is determined from the present currents and voltages in combination with the machine parameters. Separate control of torque and flux-forming current enables a high drive dynamic at a high load moment.

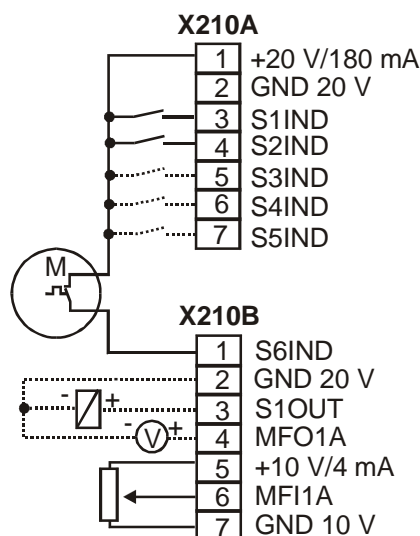

Control terminal X210A	
X210A.1	Supply voltage +20 V
X210A.2	Ground 20 V
X210A.3	Controller release / error acknowledgment
X210A.4	Start of clockwise operation
X210A.5	Start of anticlockwise operation
X210A.6	Data set change-over 1
X210A.7	Data set change-over 2

Control terminal X210B	
X210B.1	Motor thermal contact
X210B.2	Ground 20 V
X210B.3	Operating message
X210B.4	Analog signal of actual frequency
X210B.5	Supply voltage +10 V Reference value potentiometer
X210B.6	Reference speed 0 ...+10 V
X210B.7	Ground 10 V

7.6.2.4 Configuration 411 – Sensorless Field-Oriented Control with Technology Controller

Configuration 411 extends the functionality of the sensor-less field-oriented control of Configuration 410 by a Technology Controller. The Technology Controller enables a control based on parameters such as flow rate, pressure, filling level or speed.

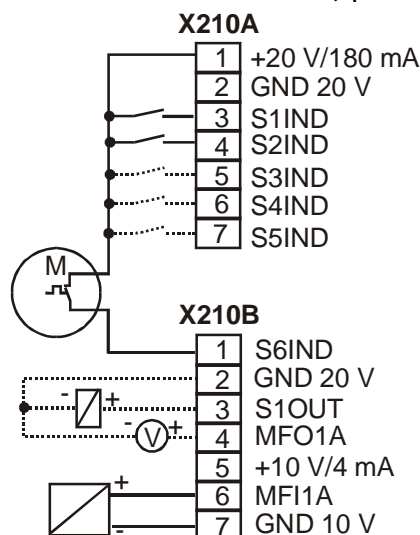

Control terminal X210A	
X210A.1	Supply voltage +20 V
X210A.2	Ground 20 V
X210A.3	Controller release / error acknowledgment
X210A.4	Fixed percentage value change-over 1
X210A.5	no function assigned
X210A.6	Data set change-over 1
X210A.7	Data set change-over 2

Control terminal X210B	
X210B.1	Motor thermal contact
X210B.2	Ground 20 V
X210B.3	Operating message
X210B.4	Analog signal of actual frequency
X210B.5	Supply voltage +10 V
X210B.6	Actual percentage value 0 ...+10 V
X210B.7	Ground 10 V

7.6.2.5 Configuration 430 – Sensorless Field-Oriented Control, speed or torque controlled

Configuration 430 extends the functionality of the sensor-less field-oriented control of Configuration 410 by a Torque Controller. The reference torque is represented as a percentage, and it is transmitted into the corresponding operational performance of the application. Change-over between variable-speed control and torque-dependent control is done via a digital control input.

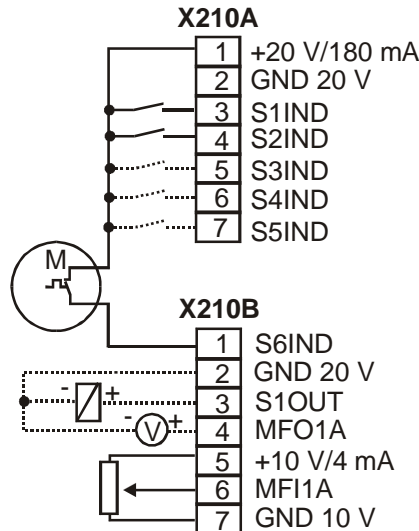

Control terminal X210A	
X210A.1	Supply voltage +20 V
X210A.2	Ground 20 V
X210A.3	Controller release / error acknowledgment
X210A.4	Start of clockwise operation
X210A.5	n-/T change-over control function
X210A.6	Data set change-over 1
X210A.7	Data set change-over 2

Control terminal X210B	
X210B.1	Motor thermal contact
X210B.2	Ground 20 V
X210B.3	Operating message
X210B.4	Analog signal of actual frequency
X210B.5	Supply voltage +10 V Reference value potentiometer
X210B.6	Reference speed 0 ...+10 V
X210B.7	Ground 10 V

7.6.2.6 Configuration 210 – Field-Oriented Control, speed controlled

Configuration 210 contains the functions for speed-controlled, field-oriented control of a 3-phase machine with speed sensor feedback. The separate control of torque and flux-forming current enables high drive dynamics with a high load moment. The necessary speed sensor feedback results in a precise speed and torque performance.

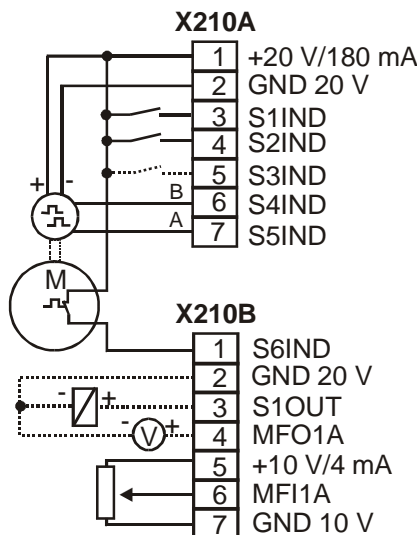

Control terminal X210A	
X210A.1	Supply voltage +20 V
X210A.2	Ground 20 V
X210A.3	Controller release / error acknowledgment
X210A.4	Start of clockwise operation
X210A.5	Start of anticlockwise operation
X210A.6	Speed sensor track B
X210A.7	Speed sensor track A

Control terminal X210B	
X210B.1	Motor thermal contact
X210B.2	Ground 20 V
X210B.3	Operating message
X210B.4	Analog signal of actual frequency
X210B.5	Supply voltage +10 V Reference value potentiometer
X210B.6	Reference speed 0 ...+10 V
X210B.7	Ground 10 V

7.6.2.7 Configuration 211 – Field-Oriented Control, with Technology Controller

Configuration 211 extends the functionality of the speed-controlled, field-oriented control of Configuration 210 by a Technology Controller. The Technology Controller enables a control based on parameters such as flow rate, pressure, filling level or speed.

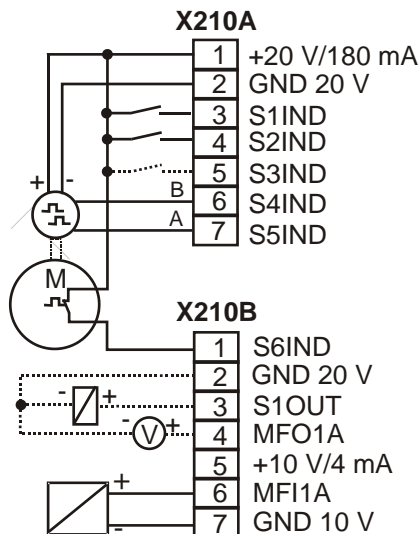

Control terminal X210A	
X210A.1	Supply voltage +20 V
X210A.2	Ground 20 V
X210A.3	Controller release / error acknowledgment
X210A.4	Fixed percentage value change-over 1
X210A.5	no function assigned
X210A.6	Speed sensor track B
X210A.7	Speed sensor track A

Control terminal X210B	
X210B.1	Motor thermal contact
X210B.2	Ground 20 V
X210B.3	Operating message
X210B.4	Analog signal of actual frequency
X210B.5	Supply voltage +10 V
X210B.6	Actual percentage value 0 ...+10 V
X210B.7	Ground 10 V

7.6.2.8 Configuration 230 – Field-Oriented Control, speed and torque controlled

Configuration 230 extends the functionality of Configuration 210 by functions for torque-dependent, field-oriented control. The reference torque is represented as a percentage, and it is transmitted into the corresponding operational performance of the application. Change-over between variable-speed control and torque-dependent control is done via a digital control input.

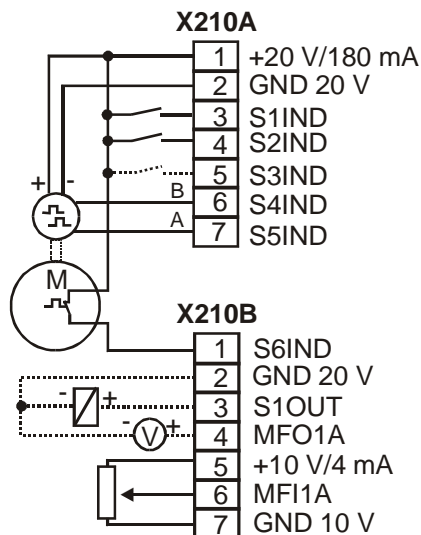

Control terminal X210A	
X210A.1	Supply voltage +20 V
X210A.2	Ground 20 V
X210A.3	Controller release / error acknowledgment
X210A.4	Start of clockwise operation
X210A.5	n-/T change-over control function
X210A.6	Speed sensor track B
X210A.7	Speed sensor track A

Control terminal X210B	
X210B.1	Motor thermal contact
X210B.2	Ground 20 V
X210B.3	Operating message
X210B.4	Analog signal of actual frequency
X210B.5	Supply voltage +10 V Reference value potentiometer
X210B.6	Reference speed 0 ...+10 V
X210B.7	Ground 10 V

7.6.3 Installation notes according to UL508c

NOTICE

No branch circuit protection

Integral solid state short circuit protection does not provide branch circuit protection.

- Branch circuit protection must be provided in accordance with the Manufacturer Instructions, National Electrical Code and any additional local codes.

For an installation according to UL508c the motor must be supervised regarding the thermal behavior. The connection and the parameter settings for the temperature motor supervision is described in chapter 14.6 "Motor Temperature" and 16.4.4 "Thermo-contact" .

For an installation according to UL508c only allowed fuses can be used for mains protection. The allowed fuses are described in chapter 5 "Technical Data".

For an installation according to UL508c the in chapter 5 "Technical Data" described maximum temperatures must not be exceeded.

For an installation according to UL508c only 60/75°C copper conductors are allowed to be used.

For an installation according to UL508c the devices are only allowed to be used in environments according to Pollution Degree 2.

According to UL508c Warn- or Marking labels are not allowed to be removed.

8 Control Unit KP500

The optional KP500 control unit is a practical tool for controlling the frequency inverter and setting and displaying the frequency inverter parameters.

The control unit is not absolutely necessary for the operation of the frequency inverter and can be plugged on when required.

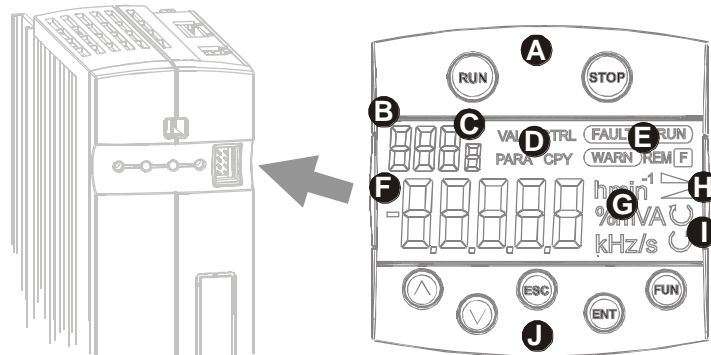

Keys

A	RUN	Used for starting the drive and opening the CTRL menu. Press the RUN key to open the motor potentiometer function.
	STOP	Used for opening the CTRL menu, stopping the drive and acknowledging faults.
J	▲ ▼	Used for navigating in the menu structure and selecting parameters. Used for increasing/decreasing parameter values.
	ENT	Accessing parameters or changing the menu within the menu structure. Confirmation of the selected function or the set parameter.
	ESC	Used for aborting parameters or switching back to the previous menu within the menu structure. Canceling the function or resetting the parameter value.
	FUN	Used for switching over the key function, access to special functions.

Display

B	Three-digit 7-segment display to show the parameter number.	
C	One-digit 7-segment display for display of the active data record, direction of rotation etc.	
D	Display of the selected menu branch:	
	VAL	Display actual values.
	PARA	Select parameters and adjust parameter values.
	CTRL	Select a function for adjustment and/or display via the control unit: SETUP guided commissioning. Ctrl motor potentiometer and jog function.
	CPY	Copy parameters via the control unit: ALL All the parameter values are copied. Act Only the active parameter values are copied. FOr Control unit memory is formatted and deleted.
E	Status and operating messages:	
	WARN	Warning about a critical operating behavior.
	FAULT	Message indicating that the unit was switched off due to a fault.
	RUN	Flashing: signals readiness for operation. Lights up: signals that the unit is operating, and the output stage is enabled.
	REM	Active remote control via interface connection.
F	Function switch-over with the FUN key.	
F	Five-digit 7-segment display for display of parameter value and sign.	
G	Physical unit of the parameter value displayed.	
H	Active acceleration or deceleration ramp.	
I	Current direction of rotation of the drive.	

8.1 Menu Structure

The menu structure of the control unit is arranged as shown in the following illustration. In the optionally available PC user software VPlus, the functions and parameters are structured in various levels depending on their function. The software contains the full set of information and enables a flexible use of the parameter setting and control options.

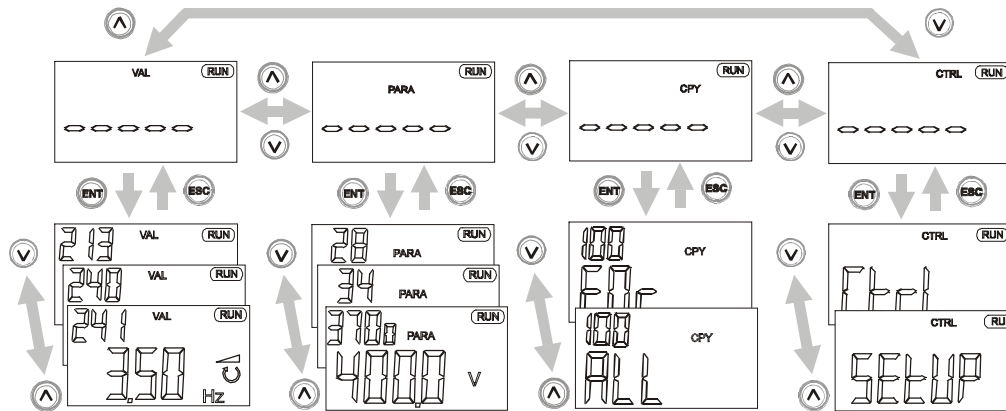

8.2 Main Menu

The various parameters and information of the frequency inverter can be displayed by means of the control unit. The different functions and parameters are grouped together in four menu branches. From any point in the menu structure, you can return to the main menu by pressing the ESC key either continuously or repeatedly.



In the following description of the key functions, a plus (+) between the key symbols indicates that the keys have to be pressed at the same time.

A comma (,) between the key symbols indicates that the keys have to be pressed one after the other.

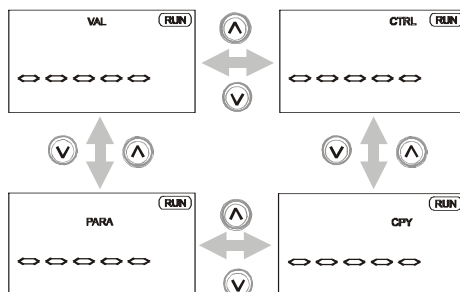

Menu branch VAL

Display of actual values

Menu branch PARA

Display and edit parameters

Menu branch CPY

Copy parameters

Menu branch CTRL

Select control and test functions

Use the arrow keys to select the required menu branch. The selected menu branch is displayed (flashing).

Select the menu branch by pressing the ENT key. The first parameter or the first function in the selected menu branch will be displayed.

Press the ESC key to return to the main menu of the control unit.

Keys	
▲ ▼	Navigate through the menu structure and select a menu branch.
ENT	Open the selected menu branch.
ESC	Cancel the current menu branch and return to the main menu.

8.3 Actual Value Menu (VAL)

In the VAL menu branch, the control unit displays a variety of actual values, depending on the configuration selected and the options installed. The parameters and basic software functions linked to the corresponding actual value are documented in the operating instructions.

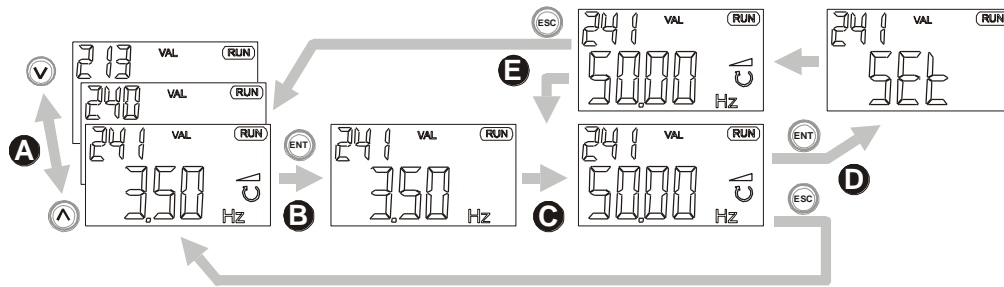

- A** Use the arrow keys to select the required number from the actual values displayed in numerical order.
In the current record, the record-related actual value parameters are displayed, including the corresponding data record number. The seven-segment display shows data record 0 if the actual values in the four data sets are identical.

Keys	
▲ + ▼	Display the actual value parameter upon switch-on.
FUN , ▲	Display last actual value parameter (highest number).
FUN , ▼	Display first actual value parameter (lowest number).

- B** Use the ENT key to select the parameter. The parameter is displayed including its current value, unit and the active data record.

- C** During commissioning, operation and error analysis, it is possible to monitor each actual value parameter specifically.
Some of the actual value parameters are arranged in the four available data records. If the parameter values in the four data records are identical, the actual value is displayed in data record 0. If the actual values in the four data records are different, diFF is displayed in data record 0.

Keys	
▲ , ▼	Switch to another of the data set in the case of related actual values.
FUN , ▲	Determine minimum value and display it permanently.
FUN , ▼	Determine maximum value and display it permanently.
FUN , ENT	Display of mean value of the actual value during the monitoring period.

- D** Use the ENT key to save the selected actual value as a parameter displayed at switch-on. The message SEt (with parameter number) is displayed for a short time. When the frequency inverter is switched on the next time, this actual value will be displayed automatically.

- E** After saving the parameter, you can monitor and display the value again. Use the ESC key to switch to the parameter selection of the VAL menu branch.

8.4 Parameter Menu (PARA)

The parameters to be configured during the guided commissioning were selected from common applications and can be supplemented as required by further settings in the PARA menu branch. The parameters and basic software functions linked to the corresponding actual value are documented in the operating instructions.

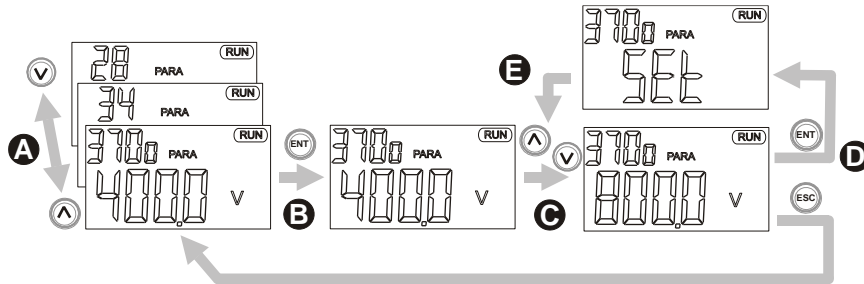

A Use the arrow keys to select the required number from the parameters displayed in numerical order. The parameter number is displayed with the active data set (flashes). In the current data set, the related parameters are displayed, including the corresponding data set number. The seven-segment display shows data set 0 if the parameter values in the four data sets are identical.

Keys	
▲ + ▼	Change to the last parameter edited.
FUN , ▲	Display of last parameter (highest number).
FUN , ▼	Display of first parameter (lowest number).

B Use the ENT key to select the parameter. The parameter is displayed including its value, unit and the active data set. If settings are edited in data set 0, the parameter values are changed in the four data sets.

C Use the arrow keys to adjust the parameter value or to select an operation mode. The adjustment possibilities you have depend on the parameter. Keep the arrow keys pressed for a while to change the displayed values quickly. If you release the keys again, the speed at which the values change is reduced again. If the parameter value starts to flash, the speed at which the values change is reset to the initial value again.

Keys	
▲ + ▼	Set parameter to factory setting.
FUN , ▲	Set parameter to highest value.
FUN , ▼	Set parameter to smallest value.
FUN , ENT	Change of the data set in the case of data set related parameters.

D Use the ENT key to save the parameter. For a short time, the message SEt including the parameter number and the data set is displayed. To leave the parameter unchanged, press the ESC key.

Messages	
Err1: EEPrO	Parameter has not been saved.
Err2: StOP	Parameter can only be read (i.e. not edited) when the unit is in operation.
Err3: Error	Other error.

E After saving the parameter, you can edit the value again or return to the parameter selection menu by pressing the ESC key.

8.5 Copy Menu (CPY)

With the copy function of the control unit you can copy the parameter values from the frequency inverter to a non-volatile memory of the control unit (upload) and store (download) them to a frequency inverter again.

The copy function makes the parameterization of recurring applications much easier. The function archives all parameter values, regardless of access control and value range. The memory space available in the control unit for the files is dynamically scaled to match the scope of the data.



The Copy Menu (CPY) is accessible in control level 3. The control level can be adjusted, if necessary, via parameter *Control Level* **28**.

8.5.1 Reading the Stored Information

When you open the CPY menu branch, the data stored in the control unit are read out. This process takes a few seconds. During this time, **init** and a progress indicator are displayed. After the initialization in the copy menu, the function can be selected.

If the information stored in the control unit is not valid, the initialization is stopped and an error message is displayed.

In this case, the memory in the control unit must be formatted as follows:

- Use the ENT key to confirm the error message.
- Use the arrow keys to select the function **FOr**.
- Use the ENT key to confirm the selection.

During the formatting operation, **FCOPY** and a progress indicator are displayed.

The process takes a few seconds. When the process is complete, the message **rdY** is displayed.

- Confirm the message by pressing the ENT key.

Now, you can select the copy function as described in the following.

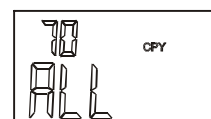
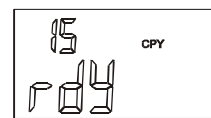
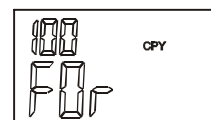
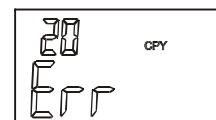
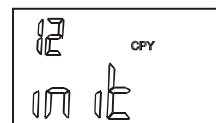

8.5.2 Menu Structure

The copy menu CPY contains three main functions. Use the arrow keys to select the required function. Select the source and the destination for the process. The memory space available in the non-volatile memory of the control unit is displayed on the three-digit seven-segment display as a percentage value.

Function – FOr

Use the function **FOr** to format and delete the memory in the control unit. This may be necessary if a new control unit is used for the first time.

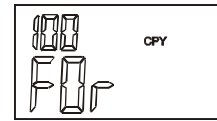

Function – ALL

All readable and writable parameter values are transferred.

- Confirm this selection by pressing the ENT key and continue by selecting the source.

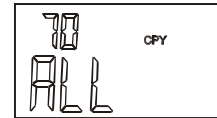

Function – Act

Only the active parameter values of the frequency inverter are copied to the control unit. The number of active parameter values depends on the current selected configuration of the frequency inverter.

When data are copied from the control unit to the frequency inverter, all parameter values stored are transferred, like in the case of the ALL function.

- Confirm the selection **Act** by pressing the ENT key and continue by selecting the source.

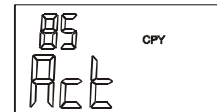

8.5.3 Selecting the Source

The parameters of the ALL and Act sub-functions in the CPY menu branch can be parameterized to meet the requirements of the specific application.

The available memory space of the control unit is shown on the seven-segment display.

- Use the arrow keys to select the data source (Src.) for the copy operation (upload). You can use either the data sets of the frequency inverter (Src. x) or the files of the control unit (Src. Fy) as the data source.
- Confirm the selected data source by pressing the ENT key and continue by selecting the destination.

Display	Description
Src. 0	The data of the four data records of the frequency inverter are copied.
Src. 1	The data of data record 1 of the frequency inverter are copied.
Src. 2	The data of data record 2 of the frequency inverter are copied.
Src. 3	The data of data record 3 of the frequency inverter are copied.
Src. 4	The data of data record 4 of the frequency inverter are copied.
Src. E	An empty data record for deletion of a file in the control unit.
Src. F1	File 1 is transferred from the memory of the control unit. 1)
Src. F2	File 2 is transferred from the memory of the control unit. 1)
Src. F3	File 3 is transferred from the memory of the control unit. 1)
Src. F4	File 4 is transferred from the memory of the control unit. 1)
Src. F5	File 5 is transferred from the memory of the control unit. 1)
Src. F6	File 6 is transferred from the memory of the control unit. 1)
Src. F7	File 7 is transferred from the memory of the control unit. 1)
Src. F8	File 8 is transferred from the memory of the control unit. 1)

1) Empty files which are not filled with data yet cannot be used as signal sources. The control unit memory is managed dynamically.

8.5.4 Selecting the Destination

Select the destination (dSt.) of the copy operation (application-specific). The data source is transferred to the selected target (download).

- Use the arrow keys to select the destination (dSt.) for the copied data (download). Depending on the data source selected, either the data records of the frequency inverter (dSt. x) or empty files of the control unit (dSt. F y) can be used as the target.
- Confirm the selection by pressing the ENT key. The copy process is started and **COPY** is displayed.

Display	Description
dSt. 0	The four data records of the frequency inverter are overwritten.
dSt. 1	The data are copied to data record 1 of the frequency inverter.
dSt. 2	The data are copied to data record 2 of the frequency inverter.
dSt. 3	The data are copied to data record 3 of the frequency inverter.
dSt. 4	The data are copied to data record 4 of the frequency inverter.
dSt. F1	The data are copied to file 1 of the control unit. 1)
dSt. F2	The data are copied to file 2 of the control unit. 1)
dSt. F3	The data are copied to file 3 of the control unit. 1)
dSt. F4	The data are copied to file 4 of the control unit. 1)
dSt. F5	The data are copied to file 5 of the control unit. 1)
dSt. F6	The data are copied to file 6 of the control unit. 1)
dSt. F7	The data are copied to file 7 of the control unit. 1)
dSt. F8	The data are copied to file 8 of the control unit. 1)

1) Already existing files are not offered as possible targets.

8.5.5 Copy Operation



Before the parameter settings are transferred to the frequency inverter, the individual parameter values are checked.

The value range and the parameter settings can differ according to the power range of the frequency inverter. If parameter values are outside of the value range, an error message will be displayed.

While the copy operation is in process, the message **COPY** and, as a progress indicator, the number of the currently copied parameter will be displayed.

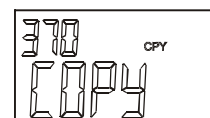

In the case of the Act function, the active parameter values are copied only. Using the ALL function, parameters which are not relevant to the selected configuration are copied, too.

Depending on the selected copy function (ALL or Act), the copy operation is completed after some 100 seconds and the display reads **rdY**.

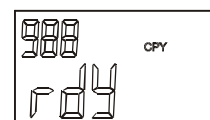

Press the ENT key to switch to the copy menu. Use the ESC key to switch to the target selection menu.

If the ESC key is pressed during the copy operation, the copy operation is aborted before the transmission of the data is complete. The message **Ab** and the number of the last parameter which was copied are displayed.

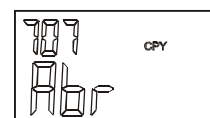

Press the ENT key to return to the selection in the copy menu. Use the ESC key to switch to the target selection menu.

8.5.6 Error Messages

The copy function archives all parameters, regardless of the access control and the value range. Some of the parameters are only writable if the frequency inverter is not in operation. The controller input (S1IND) may not be activated during the copy operation, otherwise the data transmission is aborted. The message **S1Ind** and the number of the last parameter which was copied are displayed. If the controller enable input is deactivated again, the aborted copy operation is continued.

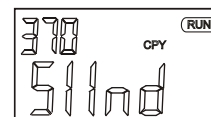

The data transmission from the selected source to the destination is continuously monitored by the copy function. If an error occurs, the copy operation is aborted and the message **Err** and an error code are displayed.

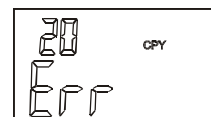

Error Messages	
Code	Meaning
0	1 Write error in memory of control unit; repeat the copy operation. If error message is displayed again, format the memory.
	2 Read error in memory of control unit; repeat the copy operation. If error message is displayed again, format the memory.
	3 The size of the memory of the control unit was not determined correctly. If this error occurs repeatedly, replace the control unit.
	4 Not enough memory; the data are incomplete. Delete the incomplete file and data no longer needed from the control unit.
	5 The communication has been disturbed or interrupted; repeat the copy operation, delete the incomplete file if necessary.
1	0 Invalid identification of a file in the control unit; delete faulty file and format memory if necessary.
	2 The memory space of the selected target file is occupied; delete file or use different target file in the control unit.
	3 The source file to be read in the control unit is empty; only files containing reasonable data should be selected as a source.
	4 Defective file in control unit; delete faulty file and format memory, if necessary.
2	0 The memory in the control unit is not formatted; format the memory via the FOr function in the copy menu.
3	0 Error during reading of a parameter from the frequency inverter; check connection between the control unit and the frequency inverter and repeat reading operation.
	1 Error during writing of a parameter in the frequency inverter; Check connection between the control unit and the frequency inverter and repeat the writing operation.
	2 Unknown parameter type; delete faulty file and format memory if necessary.
4	0 The communication has been disturbed or interrupted; repeat the copy operation, delete the incomplete file if necessary.

8.6 Read data from the KP 500 control unit

The Parameter transfer operation mode enables the transmission of data from the KP 500 control unit to the frequency inverter. In this operation mode, all functions of the control unit are disabled except for the COPY function. Data transmission from the frequency inverter to the control unit is also disabled.

Activation of the KP 500 control unit for Parameter transfer mode is prepared via the parameter *Program(ming)* **34**. For this purpose, the KP 500 control unit must be connected to the frequency inverter.

Program(ming) 34	Function
111 - Parameter transfer	The KP 500 control unit is prepared for parameter transmission. A connected frequency inverter can receive data from the control unit.
110 - Normal mode	Reset the KP 500 control unit to standard mode.



The KP 500 control unit can be activated for Parameter transfer only if at least one file is stored in the control unit. Otherwise, the error message "**FOA10**" will be displayed.

8.6.1 Activating

The KP 500 control unit can be configured both via the keys of the KP 500 and via any other available CM communication module. To configure and activate the KP 500 control unit, proceed as follows:

Activation via keyboard of the control unit

- In the parameter menu PARA, use the arrow keys to select parameter *Program(ming)* **34** and confirm the selection by pressing the ENT key.
- Use the arrow keys to enter the value **111** – Parameter transfer and confirm your selection by pressing the ENT key.

Now, the control unit is ready for activation.

Before data can be transferred, the control unit must be initialized.

- Disconnect the control unit from the frequency inverter and re-connect it to the same or another frequency inverter.

The initialization operation is started. During the initialization, **init** and a progress indicator are displayed. After the initialization, the KP 500 control unit is ready for transferring data to the frequency inverter.



Adjustment of parameter *Program(ming)* **34** to value **111** – Parameter transfer, can be undone via the control unit, provided that the control unit has not been initialized yet.

- In Parameter *Program(ming)* **34** use the arrow keys to set the value **110** – Normal operation again and confirm by pressing the **ENT** key.

Activation via CM Communication Module



Activation of the control unit via a communication connection is only possible if the frequency inverter is equipped with an optional CM communication module and the communication is affected via this module. For this purpose, the control unit must be connected to the frequency inverter.

- Establish a communication connection to the frequency inverter.
- Start the communication and select parameter *Program(ing)* **34** via the communication interface.
- Via the communication interface, enter and confirm the value 111 in parameter *Program(ing)* **34**.
- Via the communication interface, enter and confirm the value 123 in parameter *Program(ing)* **34**.

Frequency inverter is initialized again. The display of the control unit reads "rESET". Then, the initialization operation is started.

8.6.2 Transfer data

In order to transmit a file from the control unit to the frequency inverter, proceed as follows:

- Connect the KP 500 control unit to the frequency inverter.

After the initialization, the data sources which are available for download are displayed.

- Use the arrow keys to select the data source (Src.F.y) for the copy operation from the control unit to the frequency inverter.

The files stored in the control unit can be used as data sources.



The files stored in the control unit contain all information and parameters stored in the control unit according to the selected copy function ALL or Act (see chapter 8.5 "Copy Menu (CPY)").

- Confirm the selection by pressing the ENT key.

The copy operation is started. The message **COPY** and the number of the currently processed parameter will be displayed to indicate the progress of the operation.

After the copy operation is complete, the control unit is initialized again.

8.6.3 Reset to Normal Mode

A KP 500 control unit which was activated as a Download Keypad can be reset to standard operation mode with full functionality via a special key sequence on the control unit or via any available CM communication module.

Resetting at control unit

- Press the control unit keys RUN and STOP at the same time for about 1 second.

The display shows **- - - - - . Subsequent the topmost operation level of the control unit display is available.**

- In the parameter menu PARA, use the arrow keys to select parameter *Program(ming)* **34** and confirm the selection by pressing the ENT key.
- Use the arrow keys to enter the value **110** – Normal Mode and confirm your selection by pressing the ENT key.
- Disconnect the control unit from the frequency inverter and re-connect it.
- After the initialization, the control unit is ready for operation with its full functionality.

Resetting via CM communication module and/or control software VPlus



Resetting the control unit via a communication connection is only possible if the frequency inverter is equipped with an optional CM communication module and the communication is affected via this module.

- Establish a communication connection to the frequency inverter.
- Start the communication and select parameter Program(ing) **34** via the communication connection.
- Via the communication connection, enter and confirm the value 110 in parameter Program(ing) **34**.
- Via the communication connection, enter and confirm the value 123 in parameter Program(ing) **34**.

The frequency inverter is reset. The display of the control unit reads "rESEt".

After reset, the control unit is ready for operation with its full functionality.

8.7 Control Menu (CTRL)



In order to be able to control the drive via the control unit, the digital controller input S1IND must be connected and set to "High-Signal" in order to enable the output stage.

In the CTRL menu branch, various functions are available which make commissioning easier and enable the control of the inverter via the control unit.

The frequency inverters can be controlled by means of the control unit and/or a communication module. In the CTRL menu branch, various functions are available which make commissioning easier and enable the control of the inverter via the control unit.

If you want to control the frequency inverter via an optional communication module, the necessary adjustments can be made via parameter *Local/Remote* **412**. Via this parameter, you can specify which functions will be available to the controller. Depending on the operation mode selected, only some of the control menu functions are available. Refer to chapter 19.3 "Bus controller" for a detailed description of the parameter *Local/Remote* **412**.

8.8 Controlling the Motor via the Control Unit

The control unit enables controlling the connected motor in accordance with the selected operation mode of parameter *Local/Remote* **412**.



In order to be able to control the drive via the control unit, the digital controller input S1IND (controller release) must be connected and set to "High-Signal" in order to enable the output stage.

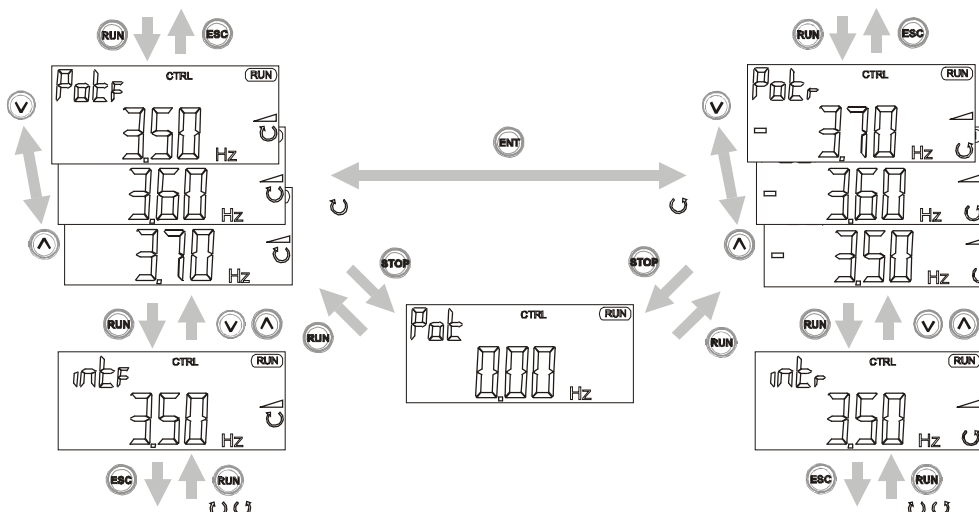

: When the RUN key was pressed, the drive was in operation already.

The CTRL menu branch can be accessed via the navigation within the menu structure. The Ctrl function contains sub-functions which are displayed according to the operating point of the frequency inverter.

Press the RUN key anywhere within the menu structure to access the motor potentiometer function **PotF** for clockwise operation or **Potr** for anti-clockwise operation directly.

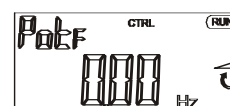
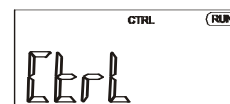

If the drive is running already, the display reads **intF** (forward, clockwise operation) / **intr** (reverse, anti-clockwise operation) for the function internal reference value or **inPF** (forward, clockwise operation) / **inPr** (reverse, anti-clockwise operation) for the function "Motorpoti (KP)".

The function Motorpoti (KP) enables a link to other reference value sources in the frequency reference value channel. The function is described in chapter 15.10.2 "Motorpoti (KP)".

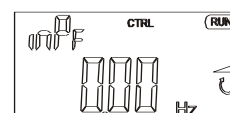
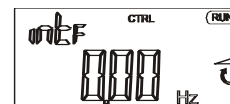

Motor potentiometer function **Pot**

Use the arrow keys to adjust the output frequency of the frequency inverter from the *minimum frequency* **418** to the *maximum frequency* **419**. The acceleration corresponds to the factory settings (2 Hz/s) for parameter *Ramp Keypad-Motorpoti* **473**. The parameters *Acceleration (Clockwise)* **420** and *Deceleration (Clockwise)* **421** are considered in the case of low acceleration values.

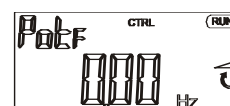

Function Motorpoti (KP) **inP**

Use the arrow keys to adjust the output frequency of the frequency inverter from the *Minimum Frequency* **418** to the *Maximum Frequency* **419**. The adjusted frequency value by means of the control unit can be connected with further reference values via *Reference Frequency Source* **475**. (Refer to chapters 15.4 "Frequency Reference Channel" and 15.10.2 "Motorpoti (KP)".)

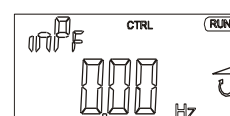

Internal reference value **int**

The drive is in operation, i.e., output signals are present at the frequency inverter and the current actual value is displayed. Press an arrow key to switch to the motor potentiometer function **Pot**. The current frequency value is taken over in the motor potentiometer function **Pot**.

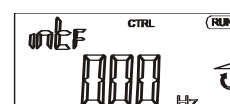

JOG frequency **JOG**

This function is useful for manual setup and positioning of a machine. The frequency of the output signal is set to the entered value if the FUN key is pressed.

Press FUN key to switch from the internal reference value **int** or the motor potentiometer function **Pot** to the parameter *JOG frequency* **489**.

Keep the FUN key pressed and press the arrow keys to adjust the required frequency.

(The frequency value last adjusted is saved as the *JOG frequency* **489**.)

Release the FUN key to stop the drive.

(The display returns to the previous function **Pot** or **int** or to **inP** if function "Motorpoti (KP)" is active.)

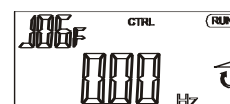

CAUTION



Unexpected system behavior

If you press the ENT key, the **direction of rotation is changed** is changed independent of the signal on the terminals Clockwise S2IND or Anticlockwise S3IND.

If the *Minimum Frequency* **418** is set to 0.00 Hz, the sense of rotation of the motor changes as soon as the sign of the reference frequency value changes.

- Note the correct operation.

Key functions

ENT	Reversal of the direction of rotation independent of the control signal on the terminals Clockwise S2IND or Anticlockwise S3IND.
ESC	Cancel function and return to the menu structure.
FUN	Switch from internal set point int or rather motor potentiometer function Pot to JOG frequency; the drive starts. Release the key to switch to the sub-function and stop the drive.
RUN	Start drive; alternative to control signal S2IND or S3IND.
STOP	Stop drive; alternative to control signal S2IND or S3IND.

9 Commissioning the Frequency Inverter

NOTICE

If filters (e.g. dU/dt filters or sine filters) are used between the frequency inverter and machine, the following must be noted.

For configurations with sensor feedback (2xx, 5xx):

- Carry out the installation with the filter connected. Note the filter manufacturer's specifications concerning permissible switching frequencies. During setup note that the filter may be overloaded thermally.

For configurations without sensor feedback (1xx, 4xx, 6xx):

- Carry out the installation without connected filters. After setup, connect the filters between the frequency inverter and the motor.

9.1 Switching on Mains Voltage

After completion of the installation work, make sure to check all control and power connections again before+- switching on the mains voltage. If all electrical connections are correct, make sure that the frequency inverter is not enabled (control input S1IND open). After power-up, the frequency inverter carries out a self-test and the relay output (X10) reports "Fault".

After a few seconds, the self-test is complete, the relay (X10) picks up and signals "no fault".

If the unit is in "as-delivered" condition or after resetting the unit to the factory settings, the guided commissioning procedure is started automatically. On the control unit, the "SetUP" menu from the menu branch CTRL is displayed.

9.2 Setup Using the Control Unit

The guided commissioning of the frequency inverter determines all parameter settings relevant to the required application. The available parameters were selected based on known standard drive applications. This facilitates the selection of the important parameters. After successful completion of the SETUP routine, the actual value *Actual frequency* **241** from the VAL menu branch is displayed on the control unit. Now, the user should check whether further parameters are relevant for the application.



The guided commissioning contains the function for parameter identification. The parameters are determined by way of measurement and set accordingly. Guided commissioning must be carried out when the machine is cold since a part of the machine data depends on the operating temperature.

NOTICE

For control of a synchronous machine and setting parameter *Configuration* **30** to "510 - FOC Syn. Speed Controlled", you will have to cancel the guided commissioning first by pressing the ESC key after the "SETUP" message and set parameter *Offset* **382**.

- To do this, proceed according to the operating instructions for the extension module EM-RES or EM-ABS-01 installed.

When the unit is in "as-delivered" condition, the guided commissioning procedure is started automatically. After successful commissioning, the guided commissioning can be carried out again later via the sub-menu CTRL.

- Use the ENT key to switch to the CTRL sub-menu.
- In the CTRL sub-menu, select the menu item "SETUP" and confirm by pressing the ENT key.
- Use the ENT key to select parameter Configuration **30**.

The available configurations are displayed automatically depending on the selected *Control level* **28**.

- Use the arrow keys to enter the number of the required configuration. (For a description of the configurations, refer to the following chapter.)

If the setup was changed, the hardware and software functionality will be configured. The message "SETUP" is displayed again.

Confirm this message by pressing the ENT key in order to continue the commissioning procedure.

- Switch to the next parameter.
- After initialization, confirm the selected configuration by pressing the ENT key.
- Continue the guided commissioning procedure according to the following chapters.

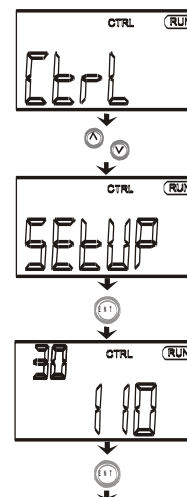

9.2.1 Configuration

Parameter *Configuration* **30** determines the assignment and basic function of the control inputs and outputs as well as the software functions. The software of the frequency inverter offers several configuration options. These differ with respect to the way in which the drive is controlled. Analog and digital inputs can be combined and complemented by optional communication protocols as further reference value sources. The operating instructions describe the configurations and the relevant parameters in the third *Control level* **28** (adjustment of parameter *Control level* **28** to value 3).

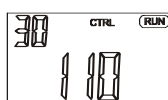

Configuration 110, sensorless control

Configuration 110 contains the functions for variable-speed control of a 3-phase machine in a wide range of standard applications. The motor speed is set according to the V/f characteristic in accordance with the voltage/frequency ratio.

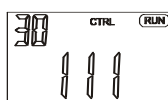

Configuration 111, sensorless control with technology controller

Configuration 111 extends the functionality of the sensor-less control by software functions for easier adaptation to the customer's requirements in different applications. The Technology Controller enables flow rate, pressure, level or speed control.

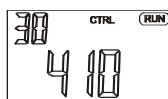

Configuration 410, sensorless field-oriented control

Configuration 410 contains functions for sensor-less, field-oriented control of a 3-phase machine. The current motor speed is determined from the present currents and voltages in combination with the machine parameters. In this configuration, parallel connection of several 3-phase motors is possible to a limited extent only.

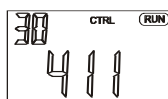

Configuration 411, sensorless field-oriented control with Technology Controller

Configuration 411 extends the functionality of Configuration 410 by a Technology Controller. The Technology Controller enables a control based on parameters such as flow rate, pressure, filling level or speed.



Configuration 430, sensorless field-oriented control with speed/torque control

Configuration 430 extends the functionality of Configuration 410 by functions for torque-dependent, field-oriented control. The reference torque is represented as a percentage and it is transmitted into the corresponding operational performance of the application. Change-over between variable-speed control and torque-dependent control is done via a digital control input.

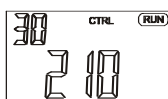

Configuration 210, field-oriented control

Configuration 210 contains the functions for speed-controlled, field-oriented control of a 3-phase machine with speed sensor feedback. The separate control of torque and flux-forming current enables high drive dynamics with a high load moment. The necessary speed sensor feedback results in a precise speed and torque performance.

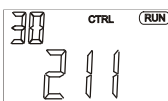

Configuration 211, field-oriented control with technology controller

Configuration 211 extends the functionality of Configuration 210 by a Technology Controller. The Technology Controller enables a control based on parameters such as flow rate, pressure, filling level or speed.

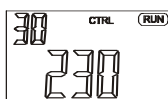

Configuration 230, field-orientated control with speed/torque control

Configuration 230 extends the functionality of Configuration 210 by functions for torque-dependent, field-oriented control. The reference torque is represented as a percentage and it is transmitted into the corresponding operational performance of the application. Change-over between variable-speed control and torque-dependent control is done via a digital control input.

9.2.2 Data Set

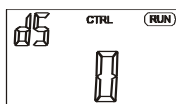

The data set change-over function enables the selection of one of four data sets for storing parameter settings.

If data set 0 is selected (factory setting), the parameter values stored in data set 0 are copied to data sets 1 through 4. In this way, all values determined during the guided commissioning procedure are saved in all data sets. In the factory settings, the frequency inverter uses data set 1 as the active data set. (For information on data set change-over via logic signals, refer to the chapter 16.4.6 "Data Set Change-Over").

For example, if data set 2 is selected for guided commissioning ("SETUP"), all values which were determined or entered are saved in this data set. In this case, the other data sets do not contain any defined values. For the operation of the frequency inverter, data set 2 must be selected as the active data set in this case.

Data Set Setup	
dS	Function
0	All data sets (DS0)
1	Data set 1 (DS1)
2	Data set 2 (DS2)
3	Data set 3 (DS3)
4	Data set 4 (DS4)

9.2.3 Motor Type

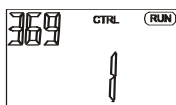

The properties of the control functions and methods to be set vary depending on the motor which is connected. The parameter *Motor type* **369** offers a range of motor variants with the corresponding table values. The verification of the entered rated values and the guided commissioning are carried out on the basis of the parameterized motor type. The selection of motor types varies depending on the requirements of the different control methods. In operating instructions the functionality and operating performance are described for 3-phase motors.

Motor type 369	Function
0 - Unknown	The motor is not a standard type.
1 - Asynchronous	Three-phase asynchronous motor, squirrel cage.
2 - Synchronous	Three-phase synchronous motor.
3 - Reluctance	Three-phase reluctance motor.
10 - Transformer	Transformer with three primary windings.

NOTICE

Polling and pre-setting of parameter values depends on the operation mode selected for parameter *Motor type* **369**.

If the motor type is not entered correctly, the drive may be damaged.

When the motor type is specified, the machine data must be entered. This is described in the following chapter. The data are polled in accordance with the table below.

9.2.4 Machine Data

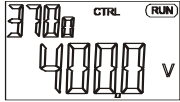

The machine data to be entered during the guided commissioning procedure are indicated on the type plate or the data sheet of the motor. The factory settings of the machine parameters are based on the nominal data of the frequency inverter and the corresponding four-pole three-phase motor. The entered and calculated machine data are checked for plausibility during the guided commissioning procedure. The user should verify the factory-set rated data of the three-phase motor.

U_{FIN} , I_{FIN} , P_{FIN} are rated values of the frequency inverter.

Parameter		Settings		
No.	Description	Min.	Max.	Default
370	Rated Voltage	$0.17 \cdot U_{FIN}$	$2 \cdot U_{FIN}$	U_{FIN}
371	Rated Current	$0.01 \cdot I_{FIN}$	$10 \cdot I_{FIN}$	I_{FIN}
372	Rated Speed	96 min^{-1}	$60\,000 \text{ min}^{-1}$	n_N
374	Rated Cosinus Phi	0.01	1.00	$\cos(\varphi)_N$
375	Rated Frequency	10.00 Hz	1000.00 Hz	50.00
376	Rated mechanical power	$0.01 \cdot P_{FIN}$	$10 \cdot P_{FIN}$	P_{FIN}

- Use the arrow keys to select the required parameter and edit the parameter value.
- Use the ENT key to confirm the selected parameter and the parameter values entered.



The rated data of the motor are to be entered according to the specifications on the rating plate for the motor connection type used (star or delta connection). If the data entered deviate from the rating plate, the parameters will not be identified correctly. Parameterize the rated data according to the specifications for the motor winding connection indicated on the rating plate. Take the higher rated current of the connected asynchronous motor into account.

9.2.5 Plausibility check

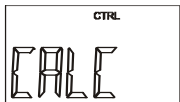

After the machine data (and the speed sensor data, if applicable) have been entered, the calculation or examination of the parameters is started automatically. The display changes over to "CALC" for a short time. If the verification of the machine data is successful, the guided commissioning procedure continues with the identification of the parameters.

Verification of the machine data should only be skipped by experienced users. The configurations contain complex control processes which depend to a large degree on the correctness of the machine parameters entered.

The warning and error messages displayed during the verification process have to be observed. If a critical condition is detected during the guided commissioning, it is displayed by the control unit. Depending on the deviation from the expected parameter value, either a warning or an error message is displayed.

- To ignore the warning or error messages, press the ENT key. The guided commissioning is continued. However, it is recommended that the data be checked and corrected if necessary.
- To correct the entered parameter values after the warning or error message, press the ESC key. Use the arrow keys to switch to the parameter value which is to be corrected.

Warning Messages	
Code	Measures / Remedy
SA000	No warning message present. This message can be read out via an optional communication module.

SA001	The value of the parameter <i>Rated voltage</i> 370 is out of the rated voltage range of the frequency inverter. The maximum reference voltage is indicated on the rating plate of the frequency inverter.
SA002	For a three-phase motor, the calculated efficiency is in the limit range. Check the values entered for the parameters <i>Rated voltage</i> 370 , <i>Rated current</i> 371 and <i>Rated power</i> 376 .
SA003	The value entered for parameter <i>Rated cos phi</i> 374 is outside of the normal range (0.6 to 0.95). Check the value.
SA004	For three-phase motor, the calculated slip is in the limit range. Check the values entered for parameters <i>Rated speed</i> 372 and <i>Rated frequency</i> 375 .

If an error message is displayed, the rated values must be checked and corrected. The guided commissioning procedure is repeated until the rated values have been entered correctly. Aborting the guided commissioning procedure by pressing ESC key should only be done by expert users because it may be possible that rated values have not been entered or determined correctly.

Error Messages	
Code	Measures / Remedy
SF000	No error message exists.
SF001	The value entered for parameter <i>Rated current</i> 371 is too low. Correct the value.
SF002	The value for parameter <i>Rated current</i> 371 is too high, referred to parameters <i>Rated power</i> 376 and <i>Rated voltage</i> 370 . Correct the values.
SF003	The value entered for parameter <i>Rated cos phi</i> 374 is wrong (greater than 1 or smaller than 0.3). Correct the value.
SF004	The calculated slip frequency is negative. Correct the values entered for parameters <i>Rated speed</i> 372 and <i>Rated frequency</i> 375 .
SF005	The calculated slip frequency is too high. Correct the values entered for parameters <i>Rated speed</i> 372 and <i>Rated frequency</i> 375 .
SF006	The calculated total output of the drive is lower than the rated power. Correct the value entered for parameter <i>Rated power</i> 376 .
SF007	The set configuration is not supported by the guided commissioning. For parameter <i>Configuration</i> 30 , select one of the configurations described in these operating instructions.

9.2.6 Parameter identification

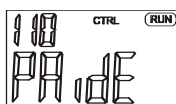

In addition to the parameterized rated data, the selected configuration demands knowledge of further machine data not stated on the rating plate of the three-phase machine. In addition to entering the rated motor parameters or as an alternative, the required machine data can also be measured during the guided commissioning process. The machine data are measured while the drive is at a standstill. The measured values are entered in the parameter automatically either directly or after the calculation. The procedure and the duration of the parameter identification depend on the type of machine connected and the device.

After checking the machine data entered, the guided commissioning switches to the parameter identification.

- Confirm the display "PAidE" by pressing the ENT key.

During the parameter identification, the connected load is measured.

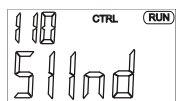

The safety functions of the frequency inverter avoid a release of the power unit if no signal is present at digital input S1IND. If a signal was already applied at the beginning of the guided commissioning, the "S1Ind" message is not displayed.



The parameter identification feature of the frequency inverter requires the presence of a signal at digital input S1IND for release of the power unit.

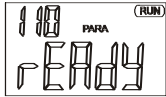

- Confirm the final "rEAdY" message by pressing the ENT key.

Canceling the operation with the ESC key or withdrawing the release signal S1IND results in an incomplete take-over of the values.



The guided commissioning contains the function for parameter identification. The parameters are determined by way of measurement and set accordingly. Guided commissioning must be carried out when the machine is cold since a part of the machine data depends on the operating temperature.

After completion of the parameter identification, warning messages may be displayed.

Depending on the warning message code, the following instructions should be followed and the measures indicated should be taken.

Warning Messages	
Code	Measures / Remedy
SA0021	The stator resistance is very high. The following causes are possible: The motor cable cross-section is not sufficient. The motor cable is too long. The motor cable is not connected correctly. The contacts are not in a proper condition (corrosion).
SA0022	The rotor resistance is very high. The following causes are possible: The motor cable cross-section is not sufficient. The motor cable is too long. The motor cable is not connected correctly. The contacts are not in a proper condition (corrosion).
SA0041	The slip speed was not determined correctly. Check the values entered for parameters <i>Rated speed 372</i> and <i>Rated frequency 375</i> .
SA0042	The slip speed was not determined correctly. Check the values entered for parameters <i>Rated speed 372</i> and <i>Rated frequency 375</i> .
SA0051	The machine data for star connection were entered, the motor, however, is connected in delta. For star operation, change the motor cable connection. For delta operation, check the entered rated motor values. Repeat the parameter identification.
SA0052	The machine data for delta connection were entered, the motor, however, is connected in star. For delta operation, change the motor cable connection. For star operation, check the entered rated motor values. Repeat the parameter identification.
SA0053	A phase asymmetry was measured. Check the cables at the terminals of the motor and the frequency inverter for proper connection and check the contacts for corrosion.

After completion or during the parameter identification, error messages may be displayed. Depending on the error code, the following instructions should be followed and the measures indicated should be taken.

Error Messages	
Code	Measures / Remedy
SF0011	The main inductance measurement has failed because the motor has a high slip. Correct the rated motor values in parameters 370, 371, 372, 374, 375 and 376 . Carry out the guided commissioning once again. In case an error message is displayed again, enter the value 110 for parameter <i>Configuration</i> 30 (sensorless regulation according to U/f-characteristic) if value 410 was set so far. Carry out the guided commissioning once again.
SF0012	The leakage inductance measurement has failed because the motor has a high slip. Correct the rated motor values in parameters 370, 371, 372, 374, 375 and 376 . Carry out the guided commissioning once again. In case an error message is displayed again, enter the value 110 for parameter <i>Configuration</i> 30 (sensorless regulation according to U/f-characteristic) if value 410 was set so far. Carry out the guided commissioning once again.
SF0021	The measurement of the stator resistance did not deliver a plausible value. Check the cables at the terminals of the motor and the frequency inverter for proper connection and check the contacts for corrosion and safe contact. Repeat the parameter identification.
SF0022	The measurement of the rotor resistance did not deliver a plausible value. Check the cables at the terminals of the motor and the frequency inverter for proper connection and check the contacts for corrosion and safe contact. Repeat the parameter identification.

9.2.7 Application data

Due to the wide range of drive applications with the resulting parameter settings it is necessary to check further parameters. The parameters polled during the guided commissioning procedure were selected from standard applications. After completion of commissioning, further parameters can be set in the PARA menu branch.

9.2.7.1 Acceleration and deceleration

The settings define how fast the output frequency changes after a reference value change or a start, stop or brake command.

Parameter		Settings		
No.	Description	Min.	Max.	Default
420	Acceleration (Clockwise)	0.00 Hz/s	999.99 Hz/s	5.00 Hz/s
421	Deceleration (Clockwise)	0.00 Hz/s	999.99 Hz/s	5.00 Hz/s

NOTICE

The deceleration of the drive is monitored in the default parameter *Operation Mode Voltage Controller* **670**. The deceleration ramp can be extended in the case of an increase in the DC link voltage during regenerative operation and/or during the braking process.

9.2.7.2 Set points at multi-functional input

The multi-functional input MFI1 can be parameterized for a reference value signal in *Operation mode* **452**. Operation mode 3 should only be selected by expert users for drive control via *Fixed frequency 1* **480** and *Fixed frequency 2* **481**.

<i>Operation mode</i> 452		Function
1 - Voltage Input	Voltage signal (MFI1A), 0V ... 10V	
2 - Current Input	Current signal (MFI1A), 0mA ... 20mA	
3 - Digital Input	Digital signal (MFI1D), 0V ... 24V	



Use multifunction input MFI1 as digital input for slow signals. For rapidly and regularly changing signals, use a digital input S2IND...S6IND or a digital input of an extension module EM.

9.2.8 Quitting commissioning

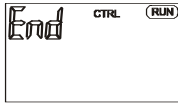

- Confirm the "End" display by pressing the ENT key.

The guided commissioning of the frequency inverter is terminated via a reset and the initialization of the frequency inverter. The relay output X10 signals a fault.

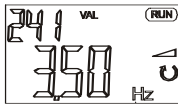

After successful initialization of the frequency inverter, the factory-set parameter *Actual frequency* **241** is displayed. If a signal is present at digital inputs S1IND (controller release) and S2IND (start clockwise operation) or at digital inputs S1IND (controller release) and S3IND (start of anti-clockwise operation), the drive is accelerated to the adjusted *minimum frequency* **418** (default values: 3.50 Hz in configurations 110, 111, 410, 411, 430 and 0.00 Hz in configurations 210, 211, 230).

9.2.8.1 Selection of an actual value for display

After commissioning, the value of parameter *Actual frequency* **241** is displayed at the control unit KP500.

If another actual value is to be displayed after a restart, make the following settings:

- Use the arrow keys to select the actual value to be displayed as from now.
- Use the ENT key to display the value of the parameter.
- Press the ENT key again. "SET" is displayed for confirmation.

As from now, the selected actual value is displayed after each restart.

If the parameter settings were made via the optional control software or in the PARA menu branch of the control unit, the display of the selected actual value must be activated manually. Use the ESC key to switch to the selection of the actual value for display again.

9.3 Check direction of rotation

To check if the reference value and the actual direction of rotation of the drive correspond to one another, proceed as follows:

- Operate the drive at low speed, i.e. specify a reference value of approx. 10%.
- Release the frequency inverter briefly {signal at digital inputs S1IND (controller release) and S2IND (start of clockwise operation) or S1IND (controller release) and S3IND (start of anti-clockwise operation)}.
- Check if the motor shaft turns in the required direction.

In case the sense of rotation is wrong, exchange two motor phases, e.g. U and V at the terminals of the frequency inverter. The mains-side connection of the frequency inverter does not affect the sense of rotation of the drive. In addition to checking the drive, the corresponding actual values and operating messages can be read out by means of the control unit.



The commissioning of the frequency inverter is complete and can be complemented by further settings in the PARA menu. The set parameters have been selected in such a way that they are sufficient for commissioning in most applications. The other settings which are relevant to the application can be checked according to the operating instructions.

If the controller release of the frequency inverter at S1IND is switched off the power output stage will be disabled. The motor will coast down or, if installed, a break will be activated.

9.4 Speed sensor

For some configurations an incremental speed sensor must be connected. Dependent on the speed sensor type it can be connected to the basic device or to an expansion module. Some applications require the connection to the basic device as well as to the expansion module.



The source of the actual speed value is selected via parameter *Actual Speed Source* **766**. By default, speed sensor 1 is used as the actual speed source. If speed sensor 2 or 3 of an expansion module delivers the actual value signal for the speed controller, speed sensor 2 must be selected as the source.

Actual Speed Source 766		Function
1 -	Speed Sensor 1	The actual speed source is speed sensor 1 of the basic device (factory setting).
2 -	Speed Sensor 2	The actual speed source is speed sensor 2 of an expansion module. ¹⁾

¹⁾ Only available if an expansion module is installed.

Dependent on the application and applied speed sensors the settings of parameters must be adapted according to the following table.

Parameter		Only speed sensor 1	Only speed sensor 2	Both speed sensors
490	Operation Mode speed sensor 1	> 0	0 - Off	> 0
491	Division Marks speed sensor 1	1...8192	X	1...8192
493	Operation Mode speed sensor 2	0 - Off	> 0	> 0
494	Division Marks speed sensor 2	X	1...8192	1...8192
495	Level	X	Selection	Selection
766	Actual Speed Source	1	2	1 or 2

X: can be set to any value, it is not evaluated

The above-mentioned parameters are selectable dependent on configuration setting and installed expansion module.



Some applications require two speed sensors. Parameter *Actual Speed Source* **766** must be set to the motor speed sensor for motor control. The other speed sensor is used externally. Comply with the application manuals "Electronic gear" and "Positioning".

9.4.1 Speed sensor 1

Connect the speed sensor tracks to the digital inputs S5IND (track A) and S4IND (track B).

The speed sensor type and the evaluation required are adjusted via the *Operation Mode* **490** of speed sensor 1.

For a detailed description of possible settings refer to section 11.4.

Parameter		Settings		
No.	Description	Min.	Max.	Fact.
490	Operation Mode speed sensor 1	Selection		
491	Division Marks speed sensor 1	1	8192	1024



Depending on the *Operation Mode* **490** of speed sensor 1 the digital inputs S4IND, S5IND and S6IND are disabled for other functions. The functions will not be evaluated. The actual speed and frequency of speed sensor 1 is displayed in Parameters **217** and **218**.

9.4.2 Speed sensor 2

WARNING



Digital inputs disabled

Depending on *Operation Mode* **493** of Speed Sensor 2, certain digital inputs of the expansion module are disabled for other functions. The functions will not be evaluated. The actual speed and frequency of speed sensor 2 is displayed in Parameters **219** and **220**.

- Check the functions connected with / depending on the digital inputs.
- Exercise caution when having safety functions controlled by digital signals.

Speed sensor 2 must be connected to an expansion module. For connection, functions and detailed parameter description refer to the applicable operation instructions manual of the expansion module.

Parameter		Settings		
No.	Description	Min.	Max.	Fact.
493	Operation Mode speed sensor 2	Selection		
494	Division Marks speed sensor 2	1	8192	1024
495	Level	Selection		

The parameters **493**, **494** and **495** are selectable dependent on the installed expansion module.

9.5 Set-up via the Communication Interface

Parameter-setting and commissioning of the frequency inverter via one of the optional communication interfaces include the plausibility check and the parameter identification functions. The parameters can be adjusted by qualified users. The parameter selection during the guided commissioning procedure includes the basic parameters. These are based on standard applications of the corresponding configuration and are therefore useful for commissioning.



WARNING

Faulty parametrization

Faulty or incorrect parametrization may lead to unwanted device behavior. This may lead to device damage or to personal injuries.

- Parameter settings may only be changed by skilled personnel. Before starting the commissioning process, read the documentation carefully and comply with the safety instructions.

The parameter *SETUP Selection 796* defines the function which is carried out directly after the selection (if controller release signal is present at digital input S1IND). The operation modes include functions which are also carried out automatically one after the other during the guided commissioning procedure.

SETUP Selection 796	Function
0 - Clear Status	The auto set-up routine does not perform a function
1 - Continue	The warning message is acknowledged and the auto set-up routine is continued.
2 - Abort	The auto set-up routine is stopped and a RESET of the frequency inverter is performed.
10 - Complete Setup, DS0	The auto set-up routine is performed in data set 0 and the parameter values are stored in all four data sets identically.
11 - Complete Setup, DS1	The parameter values of the auto set-up are stored in data set 1.
12 - Complete Setup, DS2	The parameter values of the auto set-up are stored in data set 2.
13 - Complete Setup, DS3	The parameter values of the auto set-up are stored in data set 3.
14 - Complete Setup, DS4	The parameter values of the auto set-up are stored in data set 4.
20 - Check Machine Data, DS0	The auto set-up routine checks the rated motor parameters in the four data sets.
21 - Check Machine Data, DS1	The rated motor parameters in data set 1 are checked for plausibility.
22 - Check Machine Data, DS2	The rated motor parameters in data set 2 are checked for plausibility.
23 - Check Machine Data, DS3	The rated motor parameters in data set 3 are checked for plausibility.
24 - Check Machine Data, DS4	The rated motor parameters in data set 4 are checked for plausibility.
30 - Calculation and Para-Ident., DS0	The auto set-up routine determines extended motor data via the parameter identification feature, calculates dependent parameters and stores the parameter values in all four data sets identically.
31 - Calculation and Para-Ident., DS1	Further motor data are measured, dependent parameters are calculated and the parameter values are saved in data set 1.
32 - Calculation and Para-Ident., DS2	Further motor data are measured, dependent parameters are calculated and the parameter values are saved in data set 2.
33 - Calculation and Para-Ident., DS3	Further motor data are measured, dependent parameters are calculated and the parameter values are saved in data set 3.
34 - Calculation and Para-Ident., DS4	Further motor data are measured, dependent parameters are calculated and the parameter values are saved in data set 4.

The individual steps of the auto set-up routine can be monitored and checked via parameter *SETUP Status 797*. The setup routine via the communication interface continuously updates the status parameter which can be read out via the interface.

Status Messages

Message	Meaning
Ok	Auto set-up routine has been carried out.
PC Phase 1	The plausibility check of the motor data is active.
PC Phase 2	The calculation of dependent parameters is active.
S1IND	The parameter identification requires a controller release signal at digital input S1IND.
Parameter identification	The rated motor values are checked by the parameter identification feature.
Setup already active	The setup routine via the control unit is being carried out.
No release signal	The parameter identification requires a controller release signal at digital input S1IND.
Error	Error during the auto set-up routine.
Warning phase asymmetry	The parameter identification feature diagnosed an unbalance during the measurements in the three motor phases.

Warning Messages

Code	Message	Meaning
SA0001	Rated Voltage	The value of the parameter <i>Rated voltage</i> 370 is out of the rated voltage range of the frequency inverter. The maximum reference voltage is indicated on the rating plate of the frequency inverter.
SA0002	Efficiency	For a three-phase motor, the calculated efficiency is in the limit range. Check and correct, if necessary, the values entered for the parameters <i>Rated voltage</i> 370 , <i>Rated current</i> 371 and <i>Rated power</i> 376 .
SA0003	Rated Cos Phi	The value entered for parameter <i>Rated cos phi</i> 374 is outside of the normal range (0.6 to 0.95). Correct the value.
SA0004	Slip Frequency	For three-phase motor, the calculated slip is in the limit range. Check and, if necessary, correct <i>Rated speed</i> 372 and <i>Rated frequency</i> 375 .

Error Messages

Code	Message	Meaning
SF0001	Rated current too low	The value entered for parameter <i>Rated current</i> 371 is too low. Correct the value.
SF0002	Rated current too high	The value for parameter <i>Rated current</i> 371 is too high, referred to parameters <i>Rated power</i> 376 and <i>Rated voltage</i> 370 . Correct the values.
SF0003	Rated Cos Phi	The value entered for parameter <i>Rated cos phi</i> 374 is wrong (greater than 1 or smaller than 0.3). Correct the value.
SF0004	Negative slip frequency	The calculated slip frequency is negative. Check and, if necessary, correct the values entered for parameters <i>Rated speed</i> 372 and <i>Rated frequency</i> 375 .
SF0005	Slip frequency too large	The calculated slip frequency is too high. Check and, if necessary, correct the values entered for parameters <i>Rated speed</i> 372 and <i>Rated frequency</i> 375 .
SF0006	Output balance	The calculated total output of the drive is lower than the rated power. Correct and check, if necessary, the value entered for parameter <i>Rated power</i> 376 .
SF0007	Config. not supported	The set configuration is not supported by the auto set-up routine.

10 Inverter Data

The series ACT frequency inverters are suited for a wide range of applications. The modular hardware and software structure enables customer-specific adaptation. The available hardware functionality of the frequency inverter is displayed in the control unit and the optional control software VPlus. The software parameters can be adjusted to meet the requirements of the specific application.

10.1 Serial Number

The *Serial Number 0* is entered on the nameplate during the fabrication of the frequency inverter. Information on the device type and the fabrication data (8-digit number) are indicated. Additionally, the serial number is printed on the nameplate.

Serial number **0** : **ACT410 – 09 ; 04102013**
 Nameplate: **Type: ACT410 – 09 ; Serial No.: 04102013**

10.2 Optional Modules

Modular extension of the hardware is possible via the plug-in slots. The *Optional modules 1* detected by the frequency inverter and the corresponding designations of the modules are displayed on the control unit and in the optional control software VPlus after initialization. For the parameters required for the expansion module, refer to the corresponding operating instructions.

CM-232 ; EM-IO-01

10.3 Inverter Software Version

The firmware stored in the frequency inverter defines the available parameters and functions of the software. The software version is indicated in parameter *Inverter software version 12*. In addition to the version, the 6-digit software key is printed on the name plate of the frequency inverter.

Inverter software version **12** : **4.2.3**
 Nameplate: **Version: 4.2.3 ; Software: 140 012**

10.4 Set Password

As a protection against unauthorized access, the parameter *Set password 27* can be set such that anyone who wants to change parameters must enter this password before. A change of parameter is only possible if the password is entered correctly. If the *Set password 27* parameter is set to zero, no password is required for access to the parameters. The previous password is deleted.

Parameter		Settings		
No.	Description	Min.	Max.	Default
27	Set Password	0	999	0

10.5 Control Level

The *Control level 28* defines the scope of the functions to be parameterized. The operating instructions describe the parameters on the third control level. These parameters should only be set by qualified users.

Parameter		Settings		
No.	Description	Min.	Max.	Default
28	Control Level	1	3	1

10.6 User Name

The *User name* **29** can be entered via the optional control software VPlus. The plant or machine designation cannot be displayed completely via the control unit.

32 alpha-numerical characters

10.7 Configuration

The *Configuration* **30** determines the assignment and basic function of the control inputs and outputs as well as the software functions. The software of the frequency inverters offers various configuration options. These differ with respect to the way in which the drive is controlled. Analog and digital inputs can be combined and complemented by optional communication protocols. The operating instructions describe the following configurations and the relevant parameters in the third *Control level* **28** (adjustment of parameter *Control level* **28** to value 3).

Configuration 110, sensorless control

Configuration 110 contains the functions for variable-speed control of a 3-phase machine in a wide range of standard applications. The motor speed is set according to the V/f characteristic in accordance with the voltage/frequency ratio.

Configuration 111, sensorless control with technology controller

Configuration 111 extends the functionality of the sensor-less control by software functions for easier adaptation to the customer's requirements in different applications. Depending on the application, the technology controller may be used, which enables the control of flow rate, pressure, contents level or speed.

Configuration 410, sensorless field-oriented control

Configuration 410 contains the functions for sensor-less, field-oriented control of a 3-phase machine. The current motor speed is determined from the present currents and voltages in combination with the machine parameters. In this configuration, parallel connection of several 3-phase motors is possible to a limited extent only.

Configuration 411, sensorless field-oriented control with technology controller

Configuration 411 extends the functionality of Configuration 410 by a Technology Controller, which enables the control of flow rate, pressure, contents level or speed

Configuration 430, sensorless field-oriented control with speed/torque control

Configuration 430 extends the functionality of Configuration 410 by functions for torque-dependent, field-oriented control. The reference torque is represented as a percentage and it is transmitted into the corresponding operational performance of the application. Change-over between variable-speed control and torque-dependent control is done via a digital control input.

Configuration 210, field-oriented control

Configuration 210 contains the functions for speed-controlled, field-oriented control of a 3-phase machine with speed sensor feedback. The separate control of torque and flux-forming current enables high drive dynamics with a high load moment. The necessary speed sensor feedback results in a precise speed and torque performance.

Configuration 211, field-oriented control with technology controller

Configuration 211 extends the functionality of Configuration 210 by a Technology Controller, which enables the control of flow rate, pressure, contents level or speed.

Configuration 230, field-orientated control with speed/torque control

Configuration 230 extends the functionality of Configuration 210 by functions for torque-dependent, field-oriented control. The reference torque is represented as a percentage and it is transmitted into the corresponding operational performance of the application. Change-over between variable-speed control and torque-dependent control is done via a digital control input.

In the table, you will find a list of functions which are available in the different configurations.

Function	Chapter	Configuration							
		V/f - characteristic		field-oriented control					
		sensorless		sensorless			sensor		
		110	111	410	411	430	210	211	230
Speed control	18.5.3			x		x	x	x	x
Torque control	18.5.2					x			x
Switch-over speed/torque control	16.4.5					x			x
Dynamic Voltage Pre-Control	0	x	x						
Intelligent current limits	18.1	x	x	x	x	x	x	x	x
Voltage controller	18.2	x	x	x	x	x	x	x	x
Technology controller:	18.3		x		x			x	
pressure control	18.3		x		x			x	
flow rate control	18.3		x		x			x	
Contents level control	18.3		x		x			x	
Speed control	18.3		x		x			x	
Slip compensation	18.4.1	x							
Current limit value controller	18.4.2	x	x						
Current Controller	18.5.1			x	x	x	x	x	x
Limit Value Sources	18.5.2.1			x	x	x	x	x	x
Acceleration Pre-Control	18.5.4			x	x	x	x	x	x
Field Controller	18.5.5			x	x	x	x	x	x
Modulation Controller	18.5.6			x	x	x	x	x	x
Starting behavior:	13.1	x	x	x	x	x	x	x	x
Starting current impression	13.1.1.1	x	x	x	x	x			
Flux Formation	13.1.2			x	x	x	x	x	x
Stopping behavior:	13.2	x	x	x	x	x	x	x	x
Direct current brake	13.3	x	x						
Auto Start	13.4	x	x	x	x	x	x	x	x
Search Run	13.5	x	x	x	x	x	x	x	x
Reference point positioning	13.6.1	x		x			x		
Axle Positioning	13.6.2						x		
Frequency Reference Channel	15.4	x		x		x	x		x
Reference percentage channel	15.5		x		x	x		x	x
Fixed Frequencies	15.6.1	x	x	x	x	x	x		x
Fixed Percentages	15.6.3		x		x	x		x	x
Block Frequencies	15.9	x	x	x	x	x	x		x
Repetition frequency input	15.11	x	x	x	x	x	x	x	x
Brake Chopper	19.4	x	x	x	x	x	x	x	x
Motor Circuit Breaker	19.5	x	x	x	x	x	x	x	x
V-belt Monitoring	19.6	x	x	x	x	x	x	x	x
Motor Chopper	19.7.1			x	x	x	x	x	x
Temperature Adjustment	19.7.2			x	x	x	x	x	x
Encoder Monitoring	19.7.3						x	x	x

10.8 Language

The parameters are stored in the frequency inverter in various languages. The parameter description is displayed in the selected *Language* **33**, e.g. by the PC program VPlus.

Language 33	Function
0 - Deutsch	Parameter description in German.
1 - English	Parameter description in English.
2 - Italiano	Parameter description in Italian.

10.9 Programming

The parameter *Program(ming)* **34** enables acknowledgment of a fault message and resetting to the factory settings. The display of the control unit reads "dEFLt" or "rESEt" and the LEDs indicate the status of the frequency inverter.

Program(ming) 34	Function
111 - Parameter transfer	The KP 500 control unit is prepared for parameter transmission. A connected frequency inverter can receive data from the control unit.
110 - Normal mode	Reset the KP 500 control unit to standard mode.
123 - RESET	The current error message can be acknowledged via digital input S1IND or the software parameter. The display of the control unit reads "rESEt".
4444 - Default	The parameters of the selected configuration are overwritten - except for a few exceptions - by the default settings. The display of the control unit reads "dEFLt".



The parameters *Control Level* **28**, *Language* **33** as well as *Configuration* **30** are not changed during the reset to the default settings (*Program(ing)* **34** = 4444).

11 Machine Data

The input of the machine data is the foundation for the functionality of the control functions and methods. During the guided commissioning, the necessary parameters are inquired according to the selected *Configuration 30*.

11.1 Rated Motor Parameters

Set the rated parameters of the three-phase asynchronous machine according to the name plate or the data sheet of the motor. The default settings of the machine parameters are based on the nominal data of the frequency inverter and the corresponding four-pole three-phase motor. The machine data required for the control functions and methods are checked for plausibility and calculated during the commissioning.

The user should check the rated values specified by default.

Parameter		Settings		
No.	Description	Min.	Max.	Default
370	Rated Voltage	$0.17 \cdot U_{FIN}$	$2 \cdot U_{FIN}$	U_{FIN}
371	Rated Current	$0.01 \cdot I_{FIN}$	$10 \cdot I_{FIN}$	I_{FIN}
372	Rated Speed	96 min^{-1}	$60\,000 \text{ min}^{-1}$	n_N
373	No. of Pole Pairs	1	24	2
374	Rated cosine (φ)	0.01	1.00	$\cos(\varphi)_N$
375	Rated Frequency	10.00 Hz	1000.00 Hz	50.00
376	Rated mechanical power	$0.01 \cdot P_{FIN}$	$10 \cdot P_{FIN}$	P_{FIN}

In the case of three-phase machines, the speed can be increased at a constant torque if the motor winding can be switched over from star to delta connection. The change-over results in a change of the dependent parameters by a factor of square root of 3.

NOTICE

Wrong parametrization

The rated data of the motor must be entered according to the specifications on the rating plate for the motor connection type used (star or delta connection).

If the data entered deviate from the rating plate, the parameters will not be identified correctly.

- Parameterize the rated data according to the rating plate of the motor for the wiring of the motor winding. Consider the increased rated current of the connected three-phase motor.

11.2 Further motor parameters

In particular, the field-oriented control requires the determination of further data which cannot be read off the name plate of the 3-phase machine for the precise calculation of the machine model. During the guided commissioning, the parameter identification was carried out to measure the further motor parameters.

11.2.1 Stator Resistance

The resistance of the stator winding was measured during the guided commissioning. The measured value is stored as a phase value in parameter *Stator resistance* **377** and is 3 times smaller than the winding resistance in delta connection.

By default, the equivalent stator resistance of a standard motor is entered to match the nominal power of the frequency inverter.

Parameter		Settings		
No.	Description	Min.	Max.	Default
377	Stator Resistance	0 mΩ	65535 mΩ	R _{SN}

The stator resistance can be optimized while the machine is in no-load operation. At the steady-state operating point, the torque-forming current *Isq* **216** and/or the estimated *Active current* **214** should be zero. Due to the temperature-dependent of the stator resistance, the adjustment should be done at a winding temperature which is also reached during normal operation.

A correct measurement will optimize the control functions.

11.2.2 Leakage Coefficient

The leakage coefficient of the machine defines the ratio of the leakage inductivity to the main inductivity. The torque and flux-forming current components are thus coupled via the leakage coefficient. Optimization of the leakage coefficient within the field-orientated control systems requires acceleration to various operating points of the drive. Unlike the torque-forming current *Isq* **216**, the flow-forming current *Isd* **215** should be largely independent of the load torque. The flow-forming current component is inversely proportional to the leakage coefficient. If the leakage coefficient is increased, the torque-forming current increases and the flux-forming component drops. The adjustment should result in a relatively constant actual current *Isd* **215**, matching the parameter *Rated magnetizing current* **716**, regardless of the load on the drive.

The sensorless control system uses the parameter *Leakage coefficient* **378** in order to optimize the synchronization to one drive.

Parameter		Settings		
No.	Description	Min.	Max.	Default
378	Leakage Coeff.	1.0 %	20.0 %	7.0 %

11.2.3 Magnetizing Current

The *Rated magnetizing current* **716** is a measure of the flux in the motor and thus of the voltage which is present at the machine in no-load condition depending on the speed. The guided commissioning determines this value at about 30% of the *Rated current* **371**. This current can be compared to the field current of an externally excited direct current machine.

In order to optimize the sensor-less field-oriented control system, the machine has to be operated without load at a rotational frequency which is below the *Rated frequency* **375**. The accuracy of the optimization increases with the adjusted *Switching frequency* **400** and when the drive is in no-load operation. The flux-forming actual current value *Isd* **215** to be read out should roughly match the set *Rated magnetizing current* **716**.

The field-orientated control with speed sensor feedback uses the parameterized *Rated magnetizing current* **716** for the flux in the motor.

The dependence of the magnetizing on the frequency and voltage at the corresponding nominal operating point in question is taken into account by a magnetizing characteristic. The characteristic is calculated via three points, in particular in the field weakening range above the rated frequency. The parameter identification has determined the magnetizing characteristic of the motor and set the parameters *Magnetizing current 50%* **713**, *Magnetizing current 80%* **713** and *Magnetizing current 110%* **713**.

Parameter		Settings		
No.	Description	Min.	Max.	Default
713	Magnetizing current 50% Flux	1.00%	50.00%	31.00%
714	Magnetizing current 80% Flux	1.00%	80.00%	65.00%
715	Magnetizing current 110% Flux	110.00%	197.00%	145.00%
716	Rated Magnetizing Current	$0.01 \cdot I_{FIN}$	$0 \cdot I_{FIN}$	$0.3 \cdot I_{FIN}$

11.2.4 Rated Slip Correction Factor

The rotor time constant results from the inductivity of the rotor circuit and the rotor resistance. Due to the temperature-dependence of the rotor resistance and the saturation effects of the iron, the rotor time constant is also dependent on temperature and current. The load behavior and thus the rated slip depend on the rotor time constant. The guided commissioning determines the machine data during the parameter identification and sets the parameter *Rated slip correction factor* **718** accordingly. For the fine adjustment or a check of the rotor time constant, proceed as follows: Load the machine at fifty percent of the *Rated frequency* **375**. As a result, the voltage must be approximately fifty percent of the *Rated voltage* **370**, with a maximum tolerance of 5 %. If this is not the case, the correction factor must be changed accordingly. The larger the correction factor is set, the stronger the voltage drop when the machine is loaded. The value calculated by the rotor time constants can be read out via the actual value *Current rotor time constant* **227**. The adjustment should be done at a winding temperature which is also reached during normal operation of the motor.

Parameter		Settings		
No.	Description	Min.	Max.	Default
718	Rated Slip Correction Factor	0.01%	300.00%	100.00%

11.3 Internal values

The following parameters are used for the internal processing of motor data. An adjustment is not necessary.

Parameter	
No.	Description
368	Internal value 01
399	Internal value 02
402	Internal value 03
508	Internal value 04
702	Internal value 05
703	Internal value 06
704	Internal value 07

Parameter	
No.	Description
705	Internal value 08
706	Internal value 09
707	Internal value 10
708	Internal value 11
709	Internal value 12
745	Internal value 13
798	Internal value 14

11.4 Speed sensor 1

The frequency inverters are to be adapted to the application depending on the requirements. A part of the available *Configurations 30* demand continuous measurement of the actual speed for the control functions and methods. The necessary connection of an incremental speed sensor is done on the digital control terminals S5IND (track A) and S4IND (track B) of the frequency inverter.



With extension modules EM and sensor input modules, it is also possible to connect and evaluate sensors as speed sensor 2. Please refer to the corresponding operating instructions. Speed sensor 1 and speed sensor 2 are configured independently from one another.

11.4.1 Operation mode speed sensor 1

Operation mode speed sensor 1 490 can be selected according to the connected incremental speed sensor. A unipolar speed sensor is to be connected to the standard control terminals.

<i>Operation mode 490</i>	Function
0 – Off	Speed measurement is not active; the digital inputs are available for other functions.
1 – Single Evaluation	Two-channel speed sensor with recognition of direction of rotation via track signals A and B; one signal edge is evaluated per division mark.
4 – Quadruple evaluation	Two-channel speed sensor with recognition of direction of rotation via track signals A and B; four signal edges are evaluated per division mark.
11 – Single evaluation without sign	One-channel speed sensor via track signal A; the actual speed value is positive. One signal edge is evaluated per division mark. The digital input S4IND is available for further functions.
12 – Double evaluation without sign	One-channel speed sensor via track signal A; the actual speed value is positive. Two signal edges are evaluated per division mark. The digital input S4IND is available for further functions.
101 – Single evaluation inverted	Same as in operation mode 1. The actual speed value is inverted. (Alternative to exchanging the track signals)
104 – Quadruple evaluation inverted	Same as in operation mode 4. The actual speed value is inverted. (Alternative to exchanging the track signals)
111 – Single evaluation negative	Same as operation mode 11. The actual speed value is negative.
112 – Double evaluation negative	Same as operation mode 12. The actual speed value is negative.



In configurations 210, 211 and 230, digital input S4IND is by default set for the evaluation of a speed sensor signal (track B).

If an operation mode without sign is selected (*Operation Mode 11* or *Operation Mode 12*), this input is not set for the evaluation of a speed sensor signal and can be used for other functions.

11.4.2 Division marks, speed sensor 1

The number of increments of the connected speed sensor can be adjusted via parameter *Division marks, speed sensor 1* **491**. Select the division marks of the speed sensor according to the speed range of the application.

The maximum number of division marks S_{max} is defined by the frequency limit of $f_{max}=150$ kHz of the digital inputs S5IND (track A) and S4IND (track B).

$$S_{max} = 150000 \text{ Hz} \cdot \frac{60 \text{ s/min}}{n_{max}}$$

For example:

$$S_{max} = 150000 \text{ Hz} \cdot \frac{60 \text{ s}}{1500} = 6000$$

$$f_{max} = 150000 \text{ Hz}$$

$$n_{max} = \text{Max. speed of the motor in RPM}$$

To guarantee true running of the drive, an encoder signal must be evaluated at least every 2 ms (signal frequency $f = 500$ Hz). The minimum number of division marks S_{min} of the incremental encoder for a required minimum speed n_{min} can be calculated from this requirement.

$$S_{min} = 500 \text{ Hz} \cdot \frac{60 \text{ s/min}}{A \cdot n_{min}}$$

For example:

$$S_{min} = 500 \text{ Hz} \cdot \frac{60 \text{ s}}{2 \cdot 10} = 1500$$

$$n_{min} = \text{Min. speed of the motor in RPM}$$

$$A = \text{Evaluation (1, 2, 4)}$$

Parameter		Settings		
No.	Description	Min.	Max.	Default
491	Division marks, speed sensor 1	1	8192	1024

12 System Data

The various control functions and methods according to the selected *Configuration 30* are supplemented by control and special functions. For monitoring the application, process parameters are calculated from electrical control parameters.

12.1 Actual Value System

The parameter Factor *Actual Value System 389* can be used if the drive is monitored via the parameter *Actual Value System 242*.

The *Actual Frequency 241* to be monitored is multiplied by the Factor *Actual Value System 389* and can be read out via the parameter *Actual Value System 242*, i.e. *Actual Frequency 241* x Factor *Actual Value System 389* = *Actual Value System 242*.

Parameter		Settings		
No.	Description	Min.	Max.	Default
389	Factor Actual Value System	-100.000	100.000	1.000

12.2 Volume Flow and Pressure

The parameterization of the factors *Nominal Volumetric Flow 397* and *Nominal Pressure 398* is necessary if the matching actual values *Volumetric flow 285* and *Pressure 286* are used to monitor the drive. The conversion is done using the electrical control parameters.

Volume Flow 285 and *Pressure 286* are referred to the *Effective Current 214* in the case of the sensor-less control methods. In the case of the field-oriented control methods, they are referred to the torque-forming current component *Isq 216*.

Parameter		Settings		
No.	Description	Min.	Max.	Default
397	Nominal Volumetric Flow	1 m ³ /h	99999 m ³ /h	10 m ³ /h
398	Nominal Pressure	0.1 kPa	999.9 kPa	100.0 kPa

Line mains or channel characteristic:

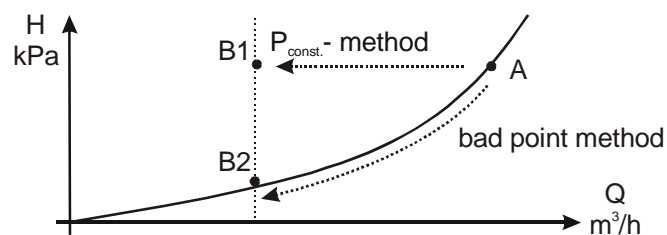

Point A in the figure describes the rating point of a pump. The transition to partial load operation mode B1 can be effected at a constant pressure H (change of conveying flow Q, pressure H remains constant). The transition to partial load operation mode B2 can be effected according to the bad point method (change of pressure H and conveying flow Q). Both methods can be realized with the integrated technology controller in configurations 111 and 211. The actual values displayed are calculated according to the bad point method independently of the selected *Operation Mode 440* of the technology controller.

13 Operational Behavior

The operational behavior of the frequency inverter can be adjusted to the application by setting the parameters appropriately. In particular the starting and stopping behavior can be selected according to the selected *Configuration 30*. Additionally, features such as Auto Start, synchronization and positioning functions facilitate the integration in the application.

13.1 Starting Behavior

The start of the 3-phase machine can be parameterized in accordance with the control functions and methods. In contrast to the sensor-less control method, the field-oriented control methods only require the definition of the limit values *Max. Flux Formation Time 780* and *Current during Flux Formation 781* for the adjustment of the starting behavior. The acceleration behavior of the sensor-less control method in configurations 110 and 111 can be selected as described in the following chapter.

13.1.1 Starting Behavior of Sensorless Control System

The parameter *Operation Mode 620* for the starting behavior is available in configurations 110 and 111. Depending on the operation mode selected, the machine is magnetized first or a starting current is impressed. The voltage drop across the stator resistance which reduces the torque in the lower frequency range can be compensated by the IxR compensation.

To ensure the correct function of the IxR compensation, the stator resistance is determined during the guided commissioning. The IxR compensation is only activated after the stator resistance was determined correctly.

<i>Operation Mode 620</i>	Starting Behavior
0 - Off	At the start the voltage with the th value of parameter <i>Starting Voltage 600</i> is set at an output frequency of 0 Hz. After this, the output voltage and the output frequency are changed according to the control method. The break-away torque and the current at the start is determined by the adjusted starting voltage. It may be necessary to optimize the starting behavior via the parameter <i>Starting Voltage 600</i> .
1 - Magnetization	In this operation mode, the <i>Current during Flux-Formation 781</i> for magnetization is impressed into the motor after release. The output frequency is kept at zero Hz for the <i>Maximum Flux-Formation Time 780</i> . After this time has expired, the output frequency follows the adjusted V/f characteristic. (see operation mode 0- Off)
2 - Magnetization + current impression	Operation mode 2 includes operation mode 1. After the <i>Maximum Flux-Formation Time 780</i> has elapsed, the output frequency is increased according to the set acceleration. If the output frequency reaches the value set with the parameter <i>Frequency Limit 624</i> , the <i>Starting Current 623</i> is withdrawn. There is a smooth transition to 1.4 times the frequency limit to the set V/f characteristic. As from this operating point, the output current depends on the load.
3 - Magnetization + IxR compensation	Operation mode 3 includes operation mode 1 of the start function. When the output frequency reaches the value set with parameter <i>Frequency Limit 624</i> , the increase of the output voltage by the IxR compensation becomes effective. The V/f characteristic is displaced by the portion of voltage which depends on the stator resistance.

Operation Mode 620		Starting Behavior
4 -	Magnetization + current imp. + IxR compensation	In this operation mode, the current set with the parameter <i>Current during Flux-Formation</i> 781 is impressed into the motor for magnetization after release. The output frequency is kept at zero Hz for the <i>Maximum Flux-Formation Time</i> 780 . After the time has elapsed, the output frequency is increased according to the set acceleration. If the output frequency reaches the value set with the parameter <i>Frequency Limit</i> 624 , the <i>Starting Current</i> 623 is withdrawn. There is a smooth transition to the V/f characteristic, and a load-dependent output current is obtained. At the same time, the increase of the output voltage by the IxR compensation becomes effective as from this output frequency. The V/f characteristic is displaced by the portion of voltage which depends on the stator resistance.
12 -	Magnetization + current imp. w. ramp stop	Operation mode 12 contains an additional function to guarantee a starting behavior under heavy duty conditions. The magnetization and starting current impression are done according to operation mode 2. The ramp stop takes the current consumption of the motor at the corresponding operating point into account and controls the frequency and voltage change by stopping the ramp. The <i>Controller Status</i> 275 signals the intervention of the controller by displaying the message "RSTP".
14 -	Magnetization + current imp. w. r. + IxR comp.	In this operation mode, the functions of operation mode 12 are extended by the compensation of the voltage drop across the stator resistance. When the output frequency reaches the value set with parameter <i>Frequency Limit</i> 624 , the increase of the output voltage by the IxR compensation becomes effective. The V/f characteristic is displaced by the portion of voltage which depends on the stator resistance.

In contrast to field-oriented control systems, sensor-less control systems feature a current controller which controls the starting behavior. The PI controller checks the current impression by parameter *Starting Current* **623**. The proportional and integrating parts of current controller can be adjusted via parameters *Amplification* **621** and *Integral Time* **622**, respectively. The control functions can be deactivated by setting the parameters to 0.

Parameter		Settings		
No.	Description	Min.	Max.	Default
621	Amplification	0.01	10.00	1.00
622	Integral Time	1 ms	30000 ms	50 ms

13.1.1.1 Starting Current

The *Starting current* **623** ensures, particularly for high-torque start, a sufficient torque until the *Frequency limit* **624** is reached.

Applications in which high current is permanently needed at a low speed are to be realized using forced-ventilated motors to prevent thermal overload.

Parameter		Settings		
No.	Description	Min.	Max.	Default
623	Starting Current	0.0 A	$0 \cdot I_{FIN}$	I_{FIN}

In the following settings, the starting current impression is used for the starting behavior:

- Configuration **30** = 1xx (V/f control of asynchronous motor),
Operation mode **620** = 2, 4, 12 or 14
- Configuration **30** = 4xx (FOC of an asynchronous motor)
- Configuration **30** = 610 (PMSM: sensor-less field-oriented control -DMC), synchronous motor

13.1.1.2 Frequency Limit

The *Starting current* **623** is impressed in configurations 110, 111, 410, 411 and 430 for control of a 3-phase machine until the *Frequency Limit* **624** is reached. Permanent operating points below the frequency limit are only admissible if forced-ventilated motors are used. The transition to the control method of the selected *configuration* **30** takes place above the frequency limit.

Parameter		Settings		
No.	Description	Min.	Max.	Default
624	Frequency Limit	0.00 Hz	100.00 Hz	2.60 Hz

13.1.2 Flux Formation

Field-oriented control in the configurations 210, 211, 230, 410, 411 and 430 are based on separate regulation of the flux-forming and torque-forming current components. Upon startup, the machine is magnetized and a current is impressed first. With the parameter *Current during Flux-Formation* **781** the magnetization current I_{sd} is set, with the parameter *Maximum Flux-Formation Time* **780** the maximum time for the current impression is set.

The current impression is done until the reference value of the rated magnetizing current is reached or the *Maximum Flux-Formation Time* **780** is exceeded.

Parameter		Settings		
No.	Description	Min.	Max.	Default
780	Maximum Flux-Formation Time	1 ms	10000 ms	300 ms ¹⁾
				1000 ms ²⁾
781	Current during Flux Formation	$0.1 \cdot I_{FIN}$	$0 \cdot I_{FIN}$	I_{FIN}

The factory setting of parameter *Maximum flux formation time* **780** depends on the setting of parameter *Configuration* **30**:

¹⁾ configurations 1xx

²⁾ configurations 2xx / 4xx

13.2 Stopping Behavior

The stopping behavior of the three-phase machine can be defined via parameter *Operation Mode 630*. Via the digital logic signals *Start Clockwise 68* and *Start Anticlockwise 69*, stopping is activated. By combining the logic signals which are assigned to the digital inputs by default, the stopping behavior can be selected from the following table.

		Stopping Behavior							
		Start Clockwise = 0 and Start Anticlockwise = 0							
Operation Mode 630		Stopping behavior 0	Stopping behavior 1	Stopping behavior 2	Stopping behavior 3	Stopping behavior 4	Stopping behavior 5	Stopping behavior 6	Stopping behavior 7
Start Clockwise = 1 and Start Anticlockwise = 1	Stopping behavior 0 (Free stopping)	0	1	2	3	4	5	6	7
	Stopping behavior 1 (Stop and Switch off)	10	11	12	13	14	15	16	17
	Stopping behavior 2 (Stop and Hold)	20	21	22	23	24	25	26	27
	Stopping behavior 3 (Stop and DC brakes)	30	31	32	33	34	35	36	37
	Stopping behavior 4 (Emergency Stop and Switch off)	40	41	42	43	44	45	46	47
	Stopping behavior 5 (Emergency Stop and Hold)	50	51	52	53	54	55	56	57
	Stopping behavior 6 (Emergency Stop and Brake)	60	61	62	63	64	65	66	67
	Stopping behavior 7 (DC brakes)	70	71	72	73	74	75	76	77

Operation Mode 630 of the stopping behavior is to be parameterized according to the matrix. The selection of the operation modes can vary according to the control method and the available control inputs.

Example: The machine is to stop according to stopping behavior 2 if the digital logic signals *Start Clockwise 68* = 0 and *Start Anticlockwise 69* = 0.

Additionally, the machine is to stop according to stopping behavior 1 if the digital logic signals *Start Clockwise 68* = 1 and *Start Anticlockwise 69* = 1.

To achieve this, the parameter *Operation Mode 630* must be set to 12.

By selecting the stopping behavior, you also select the control of a mechanical brake if operation mode „41- Open brake“ is used for one digital output for controlling the brake.

Stopping Behavior	
Stopping behavior 0 Free stopping	The inverter is disabled immediately. The drive deenergized immediately and coasts freely.
Stopping behavior 1 Stop + Switch off	The drive is brought to a standstill at the set deceleration. As soon as the drive is at a standstill, the inverter is disabled after a holding time. The holding time can be set via the parameter <i>Holding Time</i> 638 . Depending on the setting of the parameter <i>Starting Function</i> 620 , the <i>Starting Current</i> 623 is impressed or the <i>Starting Voltage</i> 600 is applied for the duration of the holding time.
Stopping behavior 2 Stop + Hold	The drive is brought to a standstill at the set deceleration and remains permanently supplied with current. Depending on the setting of the parameter <i>Starting function</i> 620 , the <i>Starting Current</i> 623 is impressed as from standstill or the <i>Starting Voltage</i> 600 is applied.
Stopping behavior 3 Stop + DC brakes	The drive is brought to a standstill at the set deceleration. As from standstill, the direct current set via parameter <i>Braking Current</i> 631 is impressed for the <i>Braking Time</i> 632. Comply with the notes in chapter 13.3 "Direct current brake". Stopping behaviors 3, 6 and 7 are only available in the configurations for V/f sensor-less control (1xx).
Stopping behavior 4 Emergency stop + switch off	The drive is brought to a standstill at the emergency stop deceleration. As soon as the drive is at a standstill, the inverter is disabled after a holding time. The holding time can be set via the parameter <i>Holding Time</i> 638. Depending on the setting of the parameter <i>Starting Function</i> 620 , the <i>Starting Current</i> 623 is impressed as from standstill or the <i>Starting Voltage</i> 600 is applied.
Stopping behavior 5 Emergency stop + Hold	The drive is brought to a standstill at the set emergency stop deceleration and remains permanently supplied with current. Depending on the setting of the parameter <i>Starting Function</i> 620 , the <i>Starting Current</i> 623 is impressed as from standstill or the <i>Starting Voltage</i> 600 is applied.
Stopping behavior 6 Emergency stop + Brake	The drive is brought to a standstill at the set emergency stop deceleration. As from standstill, the direct current set via parameter <i>Braking Current</i> 631 is impressed for the <i>Braking Time</i> 632. Comply with the notes in chapter 13.3 "Direct current brake". Stopping behaviors 3, 6 and 7 are only available in the configurations for V/f sensor-less control (1xx).
Stopping behavior 7 Direct current brake	Direct current braking is activated immediately. The direct current set with the parameter <i>Braking Current</i> 631 is impressed for the <i>Braking Time</i> 632. Comply with the notes in chapter 13.3 "Direct current brake". Stopping behaviors 3, 6 and 7 are only available in the configurations for V/f sensor-less control (1xx).

Comply with the notes for controlling a mechanical brake in chapter 13.3 "Direct current brake".

13.2.1 Switch-Off Threshold

NOTICE

Switch-off threshold too low

If the motor builds up a stopping torque, the switch-off threshold stop function may not be reached due to the slip frequency and the standstill of the drive is not recognized.

- In this case, increase the value of the *Switch-off threshold stop function* **637**.

The *Switch-off Threshold Stop Function* **637** defines the frequency as from which a standstill of the drive is recognized. This percentage parameter value is applied to the set *Maximum Frequency* **419**.

The switch-off threshold is to be adjusted according to the load behavior of the drive and the device output, as the drive must be controlled to a speed below the switch-off threshold.

Parameter		Settings		
No.	Description	Min.	Max.	Default
637	Switch-Off Threshold	0.0 %	100.0 %	1.0 %

13.2.2 Holding Time

The *Holding Time Stop Function* **638** is considered in stopping behaviors 1, 3, 4 and 6. Controlling to zero speed results in the motor heating up and should only be done for a short period in the case of internally ventilated motors.

Parameter		Settings		
No.	Description	Min.	Max.	Default
638	Holding Time	0.0 s	200.0 s	1.0 s

13.3 Direct current brake

Stopping behaviors 3, 6, 7 and the search run function include the direct current brake. Depending on the setting of the stop function, a direct current is impressed into the motor either directly or, when it is at a standstill, after the demagnetization time. The impression of the *Braking current* **631** results in the motor heating up and should only be done for a short period in the case of internally ventilated motors.

Parameter		Settings		
No.	Description	Min.	Max.	Default
631	Braking Current	0.00 A	$\sqrt{2} \cdot I_{FIN}$	$\sqrt{2} \cdot I_{FIN}$

The setting of the parameter *Braking Time* **632** defines the time-controlled stopping behavior. Contact-controlled operation of the direct current brake is activated by entering the value zero for the *Braking Time* **632**.

Time controlled:

The direct current brake is controlled by the status of signals Start clockwise and Start anti-clockwise. The current set by the parameter *Braking Current* **631** flows until the time set by the parameter *Braking Time* **632** has expired. During the braking time the status of both signals Start clockwise and Start anticlockwise are logical 0 (low) or logical 1 (high).

Contact-controlled:

If the parameter *Braking Time* **632** is set to the value 0.0 s, the direct current brake is controlled by the Start clockwise and Start anticlockwise signals. The time monitoring and limitation by *Braking Time* **632** are deactivated. The braking current flows up to the logical status 0 (low) of the controller release (S1IND).

Parameter		Settings		
No.	Description	Min.	Max.	Default
632	Braking Time	0.0 s	200.0 s	10.0 s

To avoid current surges, which can possibly lead to a fault switch-off of the frequency inverter, a direct current may only be impressed into the motor after the motor has been demagnetized. As the demagnetization time depends on the motor used, it can be set with the parameter *Demagnetizing Time* **633**.

The selected demagnetizing time should be approximately three times the *Act. Rotor Time Constant* **227**.

Parameter		Settings		
No.	Description	Min.	Max.	Default
633	Demagnetizing Time	0.1 s	30.0 s	5.0 s

The selected stopping behavior is supplemented by a current controller to control the direct current brake. The PI controller checks the current impression of the set *Braking Current* **631**. The proportional and integrating parts of current controller can be adjusted via parameters *Amplification* **634** and *Integral Time* **635**, respectively. The control functions can be deactivated by setting the parameters to 0.

Parameter		Settings		
No.	Description	Min.	Max.	Default
634	Amplification	0.00	10.00	1.00
635	Integral Time	0 ms	1000 ms	50 ms

13.4 Auto Start



WARNING

Risk due to moving parts

Due to an active auto start function portions of the system can start moving unexpectedly. This may lead to injuries or to system damage.

- Comply with VDE provision 0100 part 227 and provision 0113, in particular Sections 5.4, protection against automatic after main line voltage failure and voltage recovery, and Section 5.5 "Undervoltage protection".

Appropriate measures must be taken to exclude any risk for staff, machines and production goods.

- In addition to that, all specific regulations relevant to the application as well all national directives are to be complied with.
- When the auto start function is activated, the operator, in accordance with DIN EN 61800-5-1, shall provide a clear warning/sign in the plant, indicating automatic restart.

The Auto Start function is suitable for applications which permit a start at mains voltage by their function. By activation of the auto-start function via parameter *Operation Mode* **651**, the frequency inverter accelerates the drive after connection of the mains voltage. The controller release signal and the start command are necessary according to the regulations. When the motor is switched on, it is accelerated according to the parameterization and the reference value signal.

<i>Operation mode</i> 651		Function
0 -	Off	The drive is accelerated, after application of the mains voltage as soon as the controller enabling signal and the start command are switched from stop to start (edge evaluation).

1 -	Switched on	The drive is accelerated by the frequency inverter as soon as the mains voltage is applied (level evaluation).
-----	-------------	--

13.5 Search Run

The synchronization to a rotating drive is necessary in applications which drive the motor by their behavior or in which the drive is still rotating after a fault switch-off. Via *Operation Mode 645* = Search Run, the motor speed is synchronized to the current motor speed without an "Overcurrent" fault message. After this, the motor is accelerated to the reference speed at the set acceleration. This synchronization function determines the current rotary frequency of the drive via a search run in operation modes 1 to 5.

The synchronization in operation modes 10 to 15 is accelerated by short test impulses. Rotary frequencies of up to 175 Hz are determined within 100 ms to 300 ms. For higher frequencies, a wrong frequency is determined and the synchronization fails. In the "Quick synchronization" operation modes, the search run cannot determine whether a synchronization attempt has failed.

Operation mode 645		Function
0 -	Off	The synchronization to a rotating drive is deactivated.
1 -	Search direction acc. to specified reference value, DCB	The search direction is defined by the sign in front of the reference value. If a positive reference value (clockwise field of rotation) is entered, the search is in a positive direction (clockwise field of rotation), with a negative reference value, the search is in a negative direction (anticlockwise field of rotation).
2 -	First clockwise, then anti-clockwise, DCB	The first attempt is to synchronize to the drive in positive direction (clockwise field of rotation). If this attempt fails, it is tried to synchronize to the drive in negative direction (anticlockwise field of rotation).
3 -	First anti-clockwise, then clockwise, DCB	The first attempt is to synchronize to the drive in negative direction (anticlockwise field of rotation). If this attempt fails, it is tried to synchronize to the drive in positive direction (clockwise field of rotation).
4 -	Clockwise only, DCB	Synchronization to the drive is only done in positive direction (clockwise field of rotation).
5 -	Anti-clockwise only, DCB	Synchronization to the drive is only done in negative direction (anticlockwise field of rotation).
10 -	Quick Synchronization	An attempt is made to synchronize to the drive in positive direction (clockwise field of rotation) and in negative direction (anticlockwise field of rotation).
11 -	Quick Synch. acc. to Preset Value	The search direction is defined by the sign in front of the reference value. If a positive reference value (clockwise field of rotation) is entered, the search is in a positive direction (clockwise field of rotation), with a negative reference value, the search is in a negative direction (anticlockwise field of rotation).
14 -	Quick Sync., Clockwise Only	Synchronization to the drive is only done in positive direction (clockwise field of rotation).
15 -	Quick Sync., Anti-clockwise Only	Synchronization to the drive is only done in negative direction (anticlockwise field of rotation).

Operation modes 1, 4 and 5 define a direction of rotation for the search run and avoid a deviating direction. The search run can accelerate drives by checking the rotary frequency if the drives have a low moment of inertia and/or a small load moment.

In operation modes 10 to 15, it cannot be ruled out that a wrong direction of rotation is determined in quick synchronization. For example, a frequency not equal to zero may be determined although the drive is at a standstill. If there is no overcurrent, the drive is accelerated accordingly. The direction of rotation is defined in operation modes 11, 14 and 15.

The synchronization changes the parameterized starting behavior of the selected configuration. First, the start command activates the search run in order to determine the rotary frequency of the drive. In operation modes 1 to 5, the *Current / Rated motor current* **647** is used for synchronization as a percentage of the *Rated current* **371**.

Parameter		Settings		
No.	Description	Min.	Max.	Default
647	Current / Rated Motor Current	1.00 %	100.00 %	70.00 %

The sensor-less control is extended for the search run by a PI-Controller, which regulates the parameterized *Current / Rated Motor Current* **647**. The proportional and integrating part of the current controller can be set via the parameters *Amplification* **648** and *Integral Time* **649**. The control functions can be deactivated by setting the parameters to 0.

Parameter		Settings		
No.	Description	Min.	Max.	Default
648	Amplification	0.00	10.00	1.00
649	Integral Time	0 ms	1000 ms	20 ms

If the parameter for synchronization *Operation Mode* **645** was set to operation mode 1 to 5 (search run), the search run is not started before the *Demagnetizing Time* **633** has elapsed.

If synchronization to the drive is not possible, the *Braking Current* **631** is impressed into the motor in operation modes 1 to 5 for the duration of the *Break.-Time after Search Run* **646**. The impression of the direct current set in the parameters of the direct current brake (DCB) results in the motor heating up and should only be done for a short period in the case of internally ventilated motors.

Parameter		Settings		
No.	Description	Min.	Max.	Default
646	Brak. Time after Search Run	0.0 s	200.0 s	10.0 s



The search run function is designed for operation with motors without brake. Brake motors may not be operated perfectly with the search run function (depending on parameterization and brake control).

13.6 Positioning

Positioning is done in operation mode "Reference positioning" via the definition of the positioning distance or in operation mode "Axle positioning" via the definition of the position angle. Reference positioning uses a digital reference signal from a selectable signal source for positioning the drive independent of the speed.

Axle positioning uses a digital reference signal from a speed sensor.

The function "Reference positioning" is available in configurations 110, 410 and 210 and is activated by selecting operation mode 1 for parameter *Operation Mode* **458**.

The function "Axle positioning" is available in configuration 210 (Operation mode 210 for parameter *Configuration* **30**) and is activated by selecting operation mode 2 for parameter *Operation Mode* **458**.

Operation mode 458		Function
0 -	Off	Positioning switched off.
1 -	Reference positioning	Positioning from reference point via definition of positioning distance (rotations). The reference point is acquired via a <i>Signal Source</i> 459 . Available in Configuration: 110, 210, 410.
2 -	Axle Positioning	Reference positioning via definition of the positioning angle, reference signal from speed sensor. Available in Configuration: 210.

13.6.1 Reference Positioning

The feedback of the current position is referred to the revolutions of the motors relative to the time of the reference signal. The accuracy of the positioning for the application to be realized is dependent on the current *Actual Frequency* **241**, the *Deceleration (Clockwise)* **421**, the *No. of Pole Pairs* **373**, the selected *Positioning distance* **460** and the parameterized control behavior.

The distance between the reference point and the required position is to be defined in motor revolutions. The calculation of the distance covered is done with the selected *Positioning distance* **460** according to the application.

The setting 0.000 U for the *Positioning distance* **460** causes an immediate stop of the drive according to the selected stopping behavior for *Operation Mode* **630**.

Parameter		Settings		
No.	Description	Min.	Max.	Default
460	Positioning Distance	0.000 U	1000000.000 U	0.000 U

The actual value parameter *Rotations* **470** facilitates the setting and optimization of the function. The revolutions of the motor displayed should correspond to the *Positioning distance* **460** at the required position.

The minimum number of revolutions needed until the required position is reached depends on the *Actual Frequency* **241** and *Deceleration (Clockwise)* **421** (or *Deceleration Anticlockwise* **423**) as well as the *No. of Pole Pairs* **373** of the motor.

$$U_{\min} = \frac{f^2}{2 \cdot a \cdot p}$$

U_{\min}	=	min. number of rotations
f	=	<i>Actual frequency</i> 241
a	=	<i>Deceleration</i> 421 (423)
p	=	<i>No. of Pole Pairs</i> 373 of motor

Example: $f = 20 \text{ Hz}$, $a = 5 \text{ Hz/s}$, $p = 2 \Rightarrow U_{\min} = 20$

At an actual frequency of 20 Hz and a deceleration of 5 Hz/s, at least 20 revolutions are required until the drive stops at the required position. This is the minimum value for the *Positioning distance* **460**, a shorter positioning distance is not possible. If the number of revolutions to the required position is to be lower, either the frequency must be reduced, the deceleration must be increased or the reference point must be shifted.

The digital signal for acquisition of the reference point and the logic link can be selected by the parameter *Signal Sources* **459**. The link of the digital inputs S2IND, S3IND and S6IND to further functions is to be checked according to selected *Configuration* **30** (e.g., in configurations 110 and 210, digital input S2IND is linked to the function "Start of clockwise operation").

The signals for positioning and a stopping behavior should not be assigned to the same digital input.

<i>Signal Sources 459</i>		Function
2 -	S2IND, falling edge	The positioning starts with the change of the logic signal from 1 (HIGH) to 0 (LOW) at the reference point.
3 -	S3IND, falling edge	
6 -	S6IND, falling edge	
1x -	SxIND, rising edge	The positioning starts with the change of the logic signal from 0 (LOW) to 1 (HIGH).
2x -	SxIND, rising/falling edge	The positioning begins with the change of the logic signal.

The acquisition of the reference position via a digital signal can be influenced by a variable dead time while the control command is read and processed. The signal propagation time is compensated by a positive value for the *Signal correction 461*. If a negative signal correction is set, processing of the digital signal is delayed.

Parameter		Settings		
No.	Description	Min.	Max.	Default
461	Signal Correction	-327.68 ms	+327.67 ms	0.00 ms

The influences on the positioning which depend on the operating point can be corrected empirically via the parameter *Load correction 462*. If the required position is not reached, the delay interval is increased by a positive load correction value. The distance between the reference point and the required position is extended. Negative values accelerate the braking process and reduce the positioning distance. The limit of the negative signal correction results from the application and the *Positioning distance 460*.

Parameter		Settings		
No.	Description	Min.	Max.	Default
462	Load Correction	-32768	+32767	0

The behavior of the positioning after the required position of the drive is reached can be defined via the parameter *Activity after positioning 463*.

<i>Activity after positioning 463</i>		Function
0 -	End of positioning	The drive is stopped with the stopping behavior of <i>Operation Mode 630</i> .
1 -	Wait for positioning signal	The drive is stopped until the next signal edge; with a new edge of the position signal, it is accelerated in the previous direction of rotation.
2 -	Reversal by new edge	The drive is held until the next signal edge; with a new edge of the position signal, it is accelerated in the opposite direction of rotation.
3 -	Positioning; off	The drive is stopped and the power output stage of the inverter is switched off.
4 -	Start by time control	The drive is stopped for the <i>Waiting Time 464</i> ; after the waiting time, it is accelerated in the previous direction of rotation.
5 -	Reversal by time control	The drive is held for the <i>Waiting Time 464</i> ; after the waiting time, it is accelerated in the opposite direction of rotation.

The position reached can be maintained for the *Waiting Time* **464**, then until the drive is accelerated according to operation mode 4 or 5.

Parameter		Settings		
No.	Description	Min.	Max.	Default
464	Waiting Time	0 ms	3600000 ms	0 ms

Positioning, Operation Mode 458 = 1

The diagram shows how the positioning to the set positioning distance is effected. The positioning distance remains constant at different frequency values. At the reference point, the position signal S_{Posi} is generated. Starting from frequency f_{max} , the positioning is effected at the set *Deceleration (Clockwise)* **421**. At a lower frequency value f_1 , the frequency remains constant for some time before the drive is stopped at the set deceleration.

If, during acceleration or deceleration of the machine, positioning is started by the signal S_{Posi} , the frequency at the time of the positioning signal is maintained.

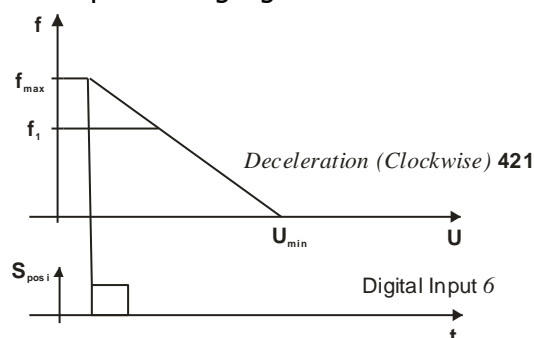

Examples of reference positioning as a function of the parameter settings selected.

- 1. The reference point is registered according to the parameter *Signal Sources* **459** in operation mode 16–S6IND, rising edge by a signal on digital input 6.
- 2. The *Positioning distance* **460** with parameter value 0.000U (default) defines a direct stop of the drive with the deceleration behavior selected in parameter *Operation Mode* 630 and the selected *Deceleration (Clockwise)* **421**. If a *Positioning distance* **460** is set, the positioning is effected at the set deceleration.
- 3. The *Signal correction* **461** of the signal propagation time from the measurement point to the frequency inverter is not used if it is set to 0 ms.
- 4. The *Load correction* **462** can compensate a faulty positioning by the load behavior. By default, this function is deactivated, i.e. set to 0.
- 5. The *Activity after positioning* **463** is defined by operation mode 0–End of positioning.
- 6. The *Waiting Time* **464** is not considered because operation mode 0 is selected for the parameter *Activity after positioning* **463**.
- 7. The actual value *Rotations* **470** enables a direct comparison to the required *Positioning distance* **460**. In the case of deviations, a *Signal correction* **461** or *Load correction* **462** can be carried out.

13.6.2 Axle Positioning

For axle positioning a feedback system is mandatory. In most cases, an expansion module for the feedback evaluation is needed as well. An optional expansion module and operating modes 1004 and 1104 for parameter *Operation mode speed sensor 2* **493** enable the evaluation of a speed sensor signal with reference impulse. The adjustment of this parameter is described in the manual of the optional expansion module. The positioning is started if a start signal is received and the frequency drops below an adjustable frequency limit. The machine stops with the selected stopping behavior at the entered position angle.

To ensure the correct function of the axle positioning, the speed controller should be optimized after the guided commissioning. This is described in the chapter 18.5.3 "Speed controller".

Via the parameter *Reference orientation* **469**, the angle between the reference point and the required position is entered.

If this value is changed while the machine is at a standstill, the positioning operation is carried out again at a frequency of 0.5 Hz. For this, a stopping behavior must be selected for the parameter *Operation Mode* **630** which impresses a starting current either permanently when the drive is at a standstill or for the stopping time (refer to chapter 13.2 "Stopping Behavior").

Parameter		Settings		
No.	Description	Min.	Max.	Default
469	Reference Orientation	0.0°	359.9°	0.0°

WARNING

Personal injury or material damage possible

During the positioning operation, the direction of rotation of the drive may change, regardless of whether the command Start clockwise or Start anticlockwise was activated.

- Make sure that the change of the direction of rotation cannot result in any personal or material damage.



The positioning is started by a start command from a signal source (e.g. digital input) which must be assigned to the parameter *Start Positioning of Axle* **37**. The signal source can be selected from the operation modes for digital inputs described in chapter 16.4 "Digital Inputs".

The positioning starts on condition that the *Actual Frequency* **241** of the output signal is lower than the value entered in parameter *Positioning Frequency* **471**. Due to a stopping behavior, the actual frequency drops below the positioning frequency.

Parameter		Settings		
No.	Description	Min.	Max.	Default
471	Positioning Frequency	1.00 Hz	50.00 Hz	50.00 Hz

Via the parameter *Max. positional error* **472**, the maximum permissible deviation from the *Reference orientation* **469** can be set.

Parameter		Settings		
No.	Description	Min.	Max.	Default
472	Max positional error	0.1°	90.0°	3.0°

Via parameter *time constant positioning contr.* **479**, the time constant for controlling the positional error can be set. The value of the time constant should be increased if oscillations of the drive around the reference orientation occur during the positioning.

Parameter		Settings		
No.	Description	Min.	Max.	Default
479	Time constant positioning controller	1.00 ms	9999.99 ms	20.00 ms

To make sure that the set position is maintained if a load torque is applied, a stopping behavior should be selected for parameter *Operation Mode* **630** which impresses a starting current either permanently when the drive is at a standstill or for the stopping time.

The status message „60-Arrived at desired Position“, which is displayed when the reference orientation is reached can be assigned to a digital output. The message is output on the following conditions:

- *Operation mode 2* (axle positioning) for parameter *Operation Mode* **458** is selected.
- The controller release signal at digital input S1IND is switched on.
- *Start Positioning of Axle* **37** is activated.
- The speed sensor monitoring is activated, i.e. operation mode 2 (error message) for parameter *Operation Mode* **760** of the speed sensor monitoring is selected.
- *Operation mode 1004* or *1104* (quadruple evaluation with reference impulse) is selected for the speed sensor input.
- The *Actual Frequency* **241** is lower than 1 Hz.
- The deviation of the current position from the reference orientation is lower than the *Max positional error* **472**.

The current position after *Start Positioning of Axle* **37** is recognized by the frequency inverter as follows:

- During commissioning, after switching on the frequency inverter, a search mode is performed for 3 rotations at a rotational frequency of 1 Hz in order to detect the reference signal. As soon as the reference signal was recognized twice, the drive is positioned to the *Reference orientation* **469**.

When using a Resolver, the search mode during commissioning is skipped.

- If the motor was already rotating before axle positioning was enabled, the positioning to the *Reference orientation* **469** is performed without search mode because the position of the reference point was already detected by the frequency inverter.

If the positioning is carried out, after controller enabling and start command, when the motor is at a **standstill**:

- The motor is positioned clockwise to the reference orientation if the value for the reference orientation is higher than the value adjusted before.
- The motor is positioned anticlockwise to the reference orientation if the value for the reference orientation is lower than the value adjusted before.

The sense of rotation during the positioning is independent of whether Start Clockwise or Start Anticlockwise was activated.

The time required until the reference orientation is reached depends on:

- Actual Frequency
- Frequency ramp for deceleration
- Rotational angle to reference orientation
- Max positional error
- Time constant positioning controller

14 Error and warning behavior

Operation of the frequency inverter and the connected load are monitored continuously. The monitoring functions are to be parameterized with the corresponding limit values specific to the application. If the limits were set below the switch-off limit of the frequency inverter, a fault switch-off can be prevented by suitable measures if a warning message is issued.

The warning message is displayed by the LEDs of the frequency inverter and can be read out on the control unit via the parameter *Warnings* **269** or output via one of the digital control outputs.

14.1 Overload Ixt

The admissible load behavior depends on various technical data of the frequency inverters and the ambient conditions.

The selected *Switching Frequency* **400** defines the nominal current and the available overload for one second and sixty seconds, respectively. The *Warning Limit Short-Term Ixt* **405** and *Warning Limit Long-Term Ixt* **406** are to be parameterized accordingly.

Parameter		Settings		
No.	Description	Min.	Max.	Default
405	Warning Limit Short Term Ixt	6 %	100 %	80 %
406	Warning Limit Long Term Ixt	6 %	100 %	80 %

14.2 Temperature

The ambient conditions and the power dissipation at the current operating point result in the frequency inverter heating up. In order to avoid a fault switch-off of the frequency inverter, the *Warning Limit Heat Sink Temperature* **407** for the heat sink temperature limit and the *Warning Limit Inside Temperature* **408** as an internal temperature limit are to be parameterized. The temperature value at which a warning message is output is calculated from the type-dependent temperature limit minus the adjusted warning limit.

The switch-off limits of the frequency inverter are an internal temperature of 65 °C and a heat sink temperature range of 80°C up to 90°C.

Parameter		Settings		
No.	Description	Min.	Max.	Default
407	Warning Limit Heat Sink Temp.	-25 °C	0 °C	-5 °C
408	Warning Limit Inside Temp.	-25 °C	0 °C	-5 °C

14.3 Controller Status

The intervention of a controller can be indicated via the control unit or LEDs. The selected control method and the matching monitoring functions prevent a switch-off of the frequency inverter. The intervention of the function changes the operating behavior of the application and can be displayed by the status messages with parameter *Controller Status* **275**. The limit values and events which result in the intervention by the corresponding controller are described in the corresponding chapters.

The behavior during the intervention of a controller is configured with the parameter *Controller Status Message* **409**.

Operation mode 409		Function
0 -	No Message	The intervention of a controller is not reported. The controllers influencing the operating behavior are displayed in the <i>Controller status</i> 275 parameter.
1 -	Warning Status	The limitation by a controller is displayed as a warning by the control unit.
11 -	Warning Status and LED	The limitation by a controller is displayed as a warning by the control unit and the LEDs.

Please refer to chapter 16.3.7 Warning Mask and chapter 22.3 Controller Status for a list of controllers and further possibilities to evaluate the controller states.

14.4 IDC Compensation Limit

At the output of the frequency inverter a DC component can occur in the output current due to unbalances. This DC voltage component can be compensated by the frequency inverter. The maximum output voltage of the compensation is set with parameter *IDC Compensation Limit* **415**. If a higher voltage than the set limit is needed for the compensation of a DC voltage component, error "F1301 IDC COMPENSATION" is triggered.

If this fault occurs, it should be checked whether the load is defective. Possibly the voltage limit may have to be increased.

If the parameter *IDC Compensation Limit* **415** is reduced to zero, the DC compensation is deactivated.

Parameter		Settings		
No.	Description	Min.	Max.	Default
415	IDC Compensation Limit	0.0 V	1.5 V	1.5 ¹⁾ 0.0 ²⁾

The factory setting of parameter *Limit IDC compensation* **415** depends on the setting of parameter *Configuration* **30**:

¹⁾ Configurations 1xx

²⁾ Configurations 2xx / 4xx

14.5 Frequency Switch-Off Limit

The maximum permissible output frequency of the frequency inverter can be set with parameter *Frequency Switch-Off Limit* **417**. If this frequency limit is exceeded by the *Stator frequency* **210** or the *Actual Frequency* **241**, the frequency inverter is switched off and the fault message "F1100" is displayed.

Parameter		Settings		
No.	Description	Min.	Max.	Default
417	Frequency Switch-Off Limit	0.00 Hz	599.00 Hz	599.00Hz

14.6 Motor Temperature

The configuration of the control terminals includes the monitoring of the motor temperature. The monitoring function can be parameterized specific to the application via the parameter *Motor Temp. Operation Mode* **570**. The integration into the application is improved by an operating mode with a delayed switch-off.

<i>Operation mode 570</i>		Function
0 -	Off	Motor temperature monitoring switched off.
1 -	Therm.-Cont.: Warning only	The critical point of operation is displayed by the control unit and parameter <i>Warnings</i> 269 .
2 -	Error Switch-Off	The fault switch-off is displayed by message F0400. The fault switch-off can be acknowledged via the control unit or the digital input.
3 -	Therm.-Cont.: Err.Switch-Off 1 min delayed	The fault switch-off according to operation mode 2 is delayed by one minute.
4 -	Therm.-Cont.: Err.Switch-Off 5 min delayed	The fault switch-off according to operation mode 2 is delayed by five minutes.
5 -	Therm.-Cont.: Err.Switch-Off 10 min delayed	The fault switch-off according to operation mode 2 is delayed by ten minutes.

Via parameter *Therm. Contact* **204**, a digital input signal can be linked to the *Motor Temp. Operation Mode* **570**.

14.7 Phase Failure

A failure of one of the three motor or mains can lead to a damage in the frequency inverter, the motor and the mechanical drive components. To prevent damage to these components, the phases failure is monitored. Parameter *Phase supervision* **576** allows to adjust the behavior in case of a failure.

<i>Phase Supervision 576</i>		Function
10 -	Mains Error Switch-Off	In the case of a phase failure, the fault switch-off takes place after 5 minutes, fault F0703 is displayed. During this time, the warning message A0100 is displayed.
11 -	Mains & Motor Error Switch-Off	The phase supervision switches the frequency inverter off: immediately, in the case of a motor phase failure; fault message F0403 is displayed, after 5 minutes in the case of a mains phase failure; fault message F0703 is displayed.
20 -	Mains Shutdown	In the case of a mains phase failure, the drive is stopped after 5 minutes, fault F0703 is displayed.
21 -	Mains & Motor Shutdown	The drive is stopped: immediately, in the case of a motor phase failure, after 5 minutes in the case of a mains phase failure.

14.8 Automatic Error Acknowledgment

The automatic error acknowledgment enables acknowledgment of the faults Overcurrent F0500, Overcurrent F0507 and Overvoltage F0700 without intervention by an overriding control system or the user. If one of these errors occurs, the frequency inverter switches off the power semi-conductors and waits for the time defined by the parameter *Restart Delay* **579**. If the error must be acknowledged, the speed of the machine is determined via the quick Search Run and it is synchronized to the rotating machine. The automatic error acknowledgment makes use of quick catching operation mode, regardless of the parameter for search run, *Operation Mode* **645**. The information given on this function in chapter 13.5 "Search Run" must be observed.

With parameter *Allowed No. of Auto-Acknowl.* **578**, you can define the number of automatic error acknowledgements which are permitted within 10 minutes.

An acknowledgement repeated above the permissible number within 10 minutes will result in the frequency inverter being switched off. The errors Overcurrent F0500, Overcurrent F0507 and Overvoltage F0700 have separate error acknowledgement counters.

Parameter		Settings		
No.	Description	Min.	Max.	Default
578	Allowed No. of Auto-Acknowl.	0	20	5
579	Restart Delay	0 ms	1000 ms	20 ms

15 Reference Values

The ACT series frequency inverters can be configured specific to the application and enable customer-specific adaptation of the module hardware and software structure.

15.1 Frequency Limits

The output frequency of the frequency inverter and thus the speed setting range are defined by the parameters *Minimum Frequency* **418** and *Maximum Frequency* **419**. The corresponding control methods use these two limit values for scaling and calculating the frequency.

Parameter		Settings		
No.	Description	Min.	Max.	Default
418	Minimum Frequency	0.00 Hz	599.00 Hz	3.50 Hz ¹⁾
				0.00 Hz ²⁾
419	Maximum Frequency	0.00 Hz	599.00 Hz	50.00 Hz

The factory setting is dependent on the adjustment of parameter *Configuration* **30**:

¹⁾ 3.5 Hz in configurations 1xx, 4xx

²⁾ 0.00 Hz in configurations 2xx

15.2 Slip Frequency

The torque-forming current component and thus the slip frequency of the 3-phase machine depend on the required torque in the case of the field-oriented control methods. The field-oriented control method also includes the parameter *Slip Frequency* **719** to limit the torque in the calculation of the machine model. The rated slip calculated from the rated motor parameters is limited in accordance with the *Slip Frequency* **719** which is parameterized as a percentage.

Parameter		Settings		
No.	Description	Min.	Max.	Default
719	Slip Frequency	0 %	10000 %	250 %

15.3 Percentage Value Limits

The setting range of the percentages is defined by the parameters *Minimum Reference Percentage* **518** and *Maximum Reference Percentage* **519**. The relevant control methods use these two limit values for scaling and calculating the frequency.

Parameter		Settings		
No.	Description	Min.	Max.	Default
518	Minimum Reference Percentage	0.00 %	300.00 %	0.00 %
519	Maximum Reference Percentage	0.00 %	300.00 %	100.00 %

15.4 Frequency Reference Channel

The various functions for the defining the reference frequency are connected via the frequency reference value channel. The *Reference Frequency Source* **475** determines the additive assignment of the available reference value sources depending on the hardware installed.

<i>Reference frequency source 475</i>	Function
1 - Abs. Analog Value MFI1A	Reference value source is the multifunctional input 1 in <i>Operation Mode</i> 452 - Analog signal.
10 - Abs. Val. Fixed Frequency (FF)	The fixed frequency according to the <i>Fixed Frequency Change-Over 1</i> 66 and <i>Fixed frequency change-over 2</i> 67 as well as the current data set.
11 - Abs. Value MFI1A + FF	Combination of the operation modes 10 and 1.
20 - Abs. Value Motorpoti (MP)	Reference value source is the function <i>Frequency Motorpoti Up</i> 62 and <i>Frequency Motorpoti Down</i> 63 .
21 - Abs. Value MFI1A + MP	Combination of the operation modes 20 and 1.
30 - Abs.Val. Speed Sensor 1 (F1)	The frequency signals in <i>Operation Mode</i> 490 are evaluated as a reference value.
31 - Abs. Val. MFI1A + F1	Combination of the operation modes 30 and 1.
32 - Abs. Repetition Frequency Input (F3)	The frequency signal on the digital input according to <i>Operation mode</i> 496 for the repetition frequency input.
33 - Abs. Val. MFI1A + F3	Combination of operation modes 1 and 32.
40 - Abs. Value Motorpoti (KP)	The KP 500 control unit is the reference value source, with keys ▲ for increasing the frequency and ▼ for reducing the frequency.
41 - Abs. Value MFI1A + KP	Combination of the operation modes 40 and 1.
80 - Abs. Val. MFI1A + FF + KP + F1 + F3 + (EM-S1INA) ¹⁾	Combination of the operation modes 1, 10, 40, 32 (+ analog input extension module) ¹⁾ .
81 - Abs. Val. MFI1A + FF + KP + F1 + F3 + (EM-S1INA) ¹⁾	Combination of the operation modes 1, 10, 40, 30, 32 (+ analog input extension module) ¹⁾ .
82 - Abs. Val. MFI1A + FF + KP + F3 + (F2) ²⁾ + (EM-S1INA) ¹⁾	Combination of the operation modes 1, 10, 40, 32 (+ absolute amount speed sensor 2 (F2)) ²⁾ (+ analog input extension module) ¹⁾ .
89 - Abs. Val. MFI1A + FF + KP + F1 + F3 + (F2) ²⁾ + (EM-S1INA) ¹⁾	Combination of the operation modes 1, 10, 40, 30, 32(+ absolute amount speed sensor 2 (F2)) ²⁾ (+ analog input extension module) ¹⁾ .
90 - Abs. Val. MFI1A + FF + MP + F3 + (EM-S1INA) ¹⁾	Combination of the operation modes 1, 10, 20, 32 (+ analog input extension module) ¹⁾ .
91 - Abs. Val. MFI1A + FF + MP + F1 + F3+ (EM-S1INA) ¹⁾	Combination of the operation modes 1, 10, 20, 30, 32 (+ analog input extension module) ¹⁾ .
92 - Abs. Val. MFI1A + FF + MP + F3 + (F2) ²⁾ + (EM-S1INA) ¹⁾	Combination of the operation modes 1, 10, 20, 32 (+ absolute amount speed sensor 2 (F2)) ²⁾ (+ analog input extension module) ¹⁾ .
99 - Abs. Val. MFI1A + FF + MP + F1 + F3 + (F2) ²⁾ + (EM-S1INA) ¹⁾	Combination of the operation modes 1, 10, 20, 30, 32 (+ absolute amount speed sensor 2 (F2)) ²⁾ (+ analog input extension module) ¹⁾ .
101 to 199	Operation modes with signs (+/-).

¹⁾ The reference value source is only available if an extension module with analog input is connected. For information, refer to the extension module operating instructions.

²⁾ The reference value source is only available if an extension module with speed sensor input is connected. For information, refer to the extension module operating instructions.

15.4.1 Block Diagram

The following table describes the software switches shown in the circuit diagram as a function of the selected *Reference Frequency Source* **475**.

Switch position on circuit diagram							
Operation mode	MF11A	FF	MP	F1	F3	KP	Sign
1	1						Abs. value
10		1					Abs. value
11	1	1					Abs. value
20			1				Abs. value
21	1		1				Abs. value
30				1			Abs. value
31	1			1			Abs. value
32					1		Abs. value
33	1				1		Abs. value
40						1	Abs. value
41	1					1	Abs. value
80	1	1			1	1	Abs. value
81	1	1		1	1	1	Abs. value
82	1	1			1	1	Abs. value
89	1	1		1	1	1	Abs. value
90	1	1	1		1		Abs. value
91	1	1	1	1	1		Abs. value
92	1	1	1		1		Abs. value
99	1	1	1	1	1		Abs. value
101	1						+/-
110		1					+/-
111	1	1					+/-
120			1				+/-
121	1		1				+/-
130				1			+/-
131	1			1			+/-
132					1		+/-
133	1				1		+/-
140						1	+/-
141	1					1	+/-
180	1	1			1	1	+/-
181	1	1		1	1	1	+/-
182	1	1			1	1	+/-
189	1	1		1	1	1	+/-
190	1	1	1		1		+/-
191	1	1	1	1	1		+/-
192	1	1	1		1		+/-
199	1	1	1	1	1		+/-

Circuit diagram of frequency reference value channel

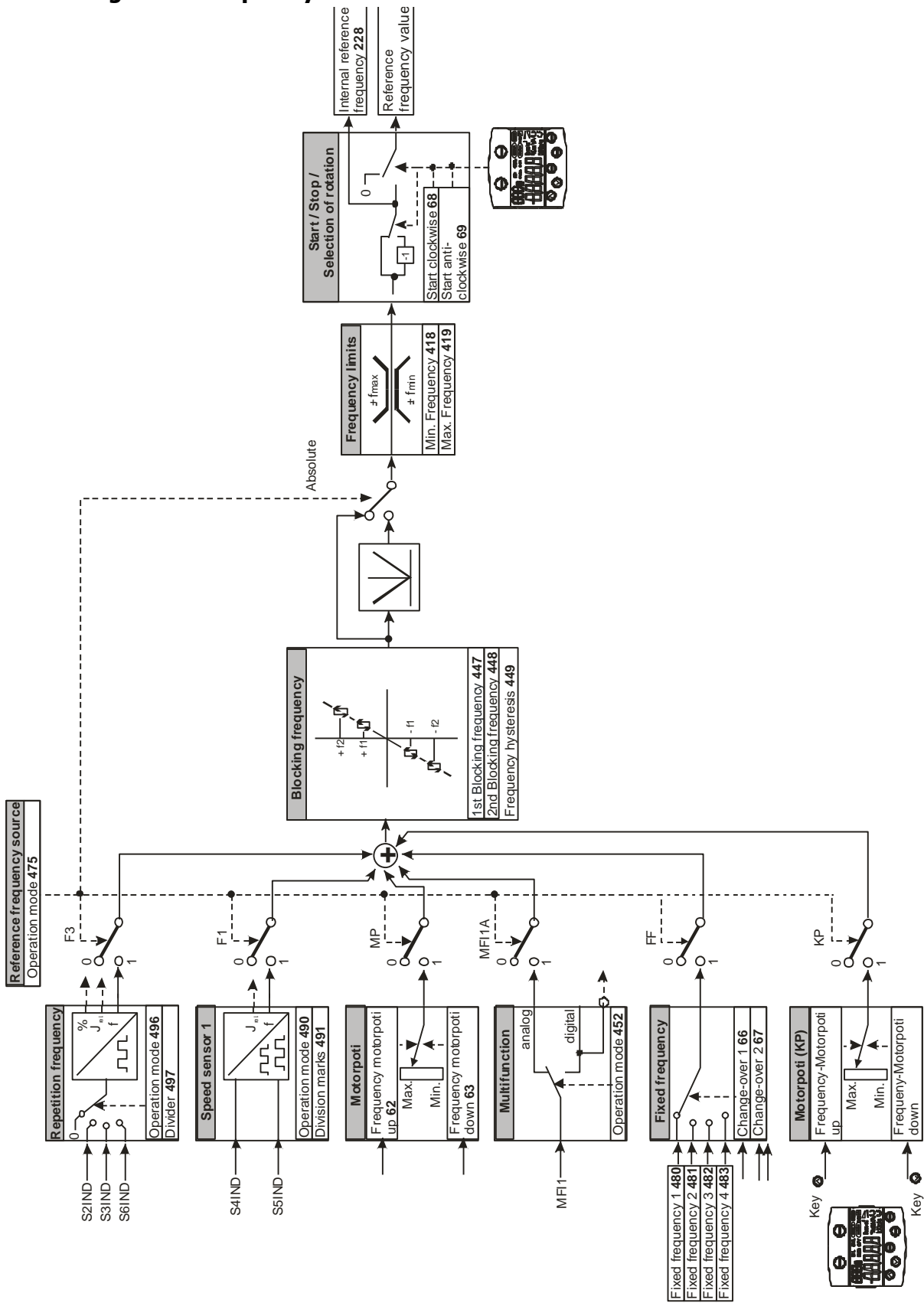

15.5 Reference Percentage Channel

The reference percentage channel combines various signal sources for definition of the reference values. The percentage scaling facilitates integration into the application, taking various process parameters into account.

The *Reference Percentage Source* **476** determines the additive assignment of the available reference value sources depending on the hardware installed.

Reference percentage source 476		Function
1 -	Abs. Analog Value MFI1A	Reference value source is the multifunctional input 1 in <i>Operation Mode</i> 452 - Analog signal.
10 -	Abs. Fix. Perc. Val. (FP)	The percentage according to <i>Fixed Percent Change-Over 1</i> 75 , <i>Fixed Percent Change-Over 2</i> 76 and the current data set.
11 -	Abs. Value MFI1A + FP	Combination of operation modes 1 and 10.
20 -	Abs. Value Motorpoti (MP)	Reference value source is the function <i>Percent Motorpoti Up</i> 72 and <i>Percent Motorpoti Down</i> 73 .
21 -	Abs. Value MFI1A + MP	Combination of operation modes 1 and 20.
32 -	Abs. Repetition Frequency Input (F3)	The frequency signal on the digital input according to <i>Operation Mode</i> 496 of the repetition frequency input.
33 -	Abs. Val. MFI1A + F3	Combination of operation modes 1 and 32.
90 -	Abs. Value MFI1A + FP + MP + F3 (+ EM-S1INA) ¹⁾	Combination of the operation modes 1, 10, 20, 32 (+ analog input of an extension module) ¹⁾ .
101 to 190		Operation modes with signs (+/-).

¹⁾ The reference value source is only available if an optional extension module with analog input is connected. For information, refer to the extension module operating instructions.

15.5.1 Block Diagram

The following table describes the software switches shown in the circuit diagram as a function of the selected *Reference Percentage Source* **476**.

Switch position on circuit diagram					
Operation mode	MFI1A	FP	MP	F3	Sign
1	1				Abs. value
10		1			Abs. value
11	1	1			Abs. value
20			1		Abs. value
21	1		1		Abs. value
32				1	Abs. value
33	1			1	Abs. value
90	1	1	1	1	Abs. value
101	1				+/-
110		1			+/-
111	1	1			+/-
120			1		+/-
121	1		1		+/-
132				1	+/-
133	1			1	+/-
190	1	1	1	1	+/-

Circuit diagram of percent reference value channel

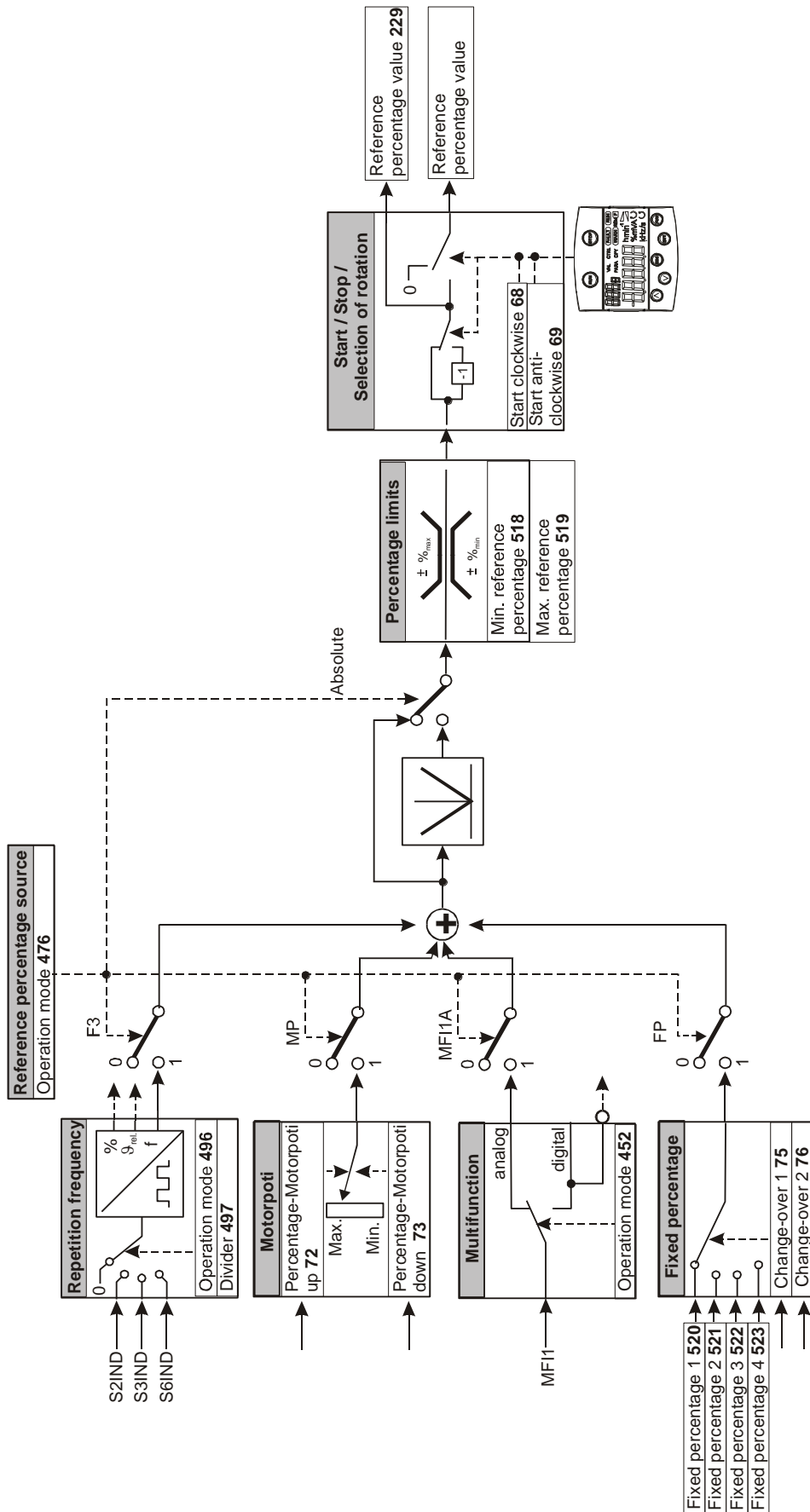

15.6 Fixed Reference Values

The fixed reference values are to be parameterized as fixed frequencies or fixed percentages according to the configuration and function.

The signs of the fixed reference values determine the direction of rotation. A positive sign means a clockwise rotation, a negative sign means an anticlockwise rotation. The direction can only be changed via the sign if the *Reference Frequency Source* **475** or *Reference Percentage Source* **476** is parameterized to an operation mode with sign (+/-). The direction of rotation can also be stated with the digital signal sources assigned to the parameters *Start Clockwise* **68** and *Start Anticlockwise* **69**.

The fixed reference values are to be parameterized in four data sets and are assigned to further sources via the reference value channel. The use of the functions *Data Set Change-Over 1* **70** and *Data Set Change-Over 2* **71** thus enables the setting of 16 fixed reference values.

15.6.1 Fixed Frequencies

The four fixed frequencies define reference values which are selected via the parameters *Fixed Frequency Change-Over 1* **66** and *Fixed Frequency Change-Over 2* **67**. The parameter *Reference Frequency Source* **475** defines the addition of the various sources in the reference frequency channel.

Parameter		Settings		
No.	Description	Min.	Max.	Default
480	Fixed Frequency 1	-599.00 Hz	599.00 Hz	0.00 Hz
481	Fixed Frequency 2	-599.00 Hz	599.00 Hz	10.00 Hz
482	Fixed Frequency 3	-599.00 Hz	599.00 Hz	25.00 Hz
483	Fixed Frequency 4	-599.00 Hz	599.00 Hz	50.00 Hz

By combining the logic states of the fixed frequency change-over modes 1 and 2, fixed frequencies 1 through 4 can be selected:

Fixed Frequency Control		
<i>Fixed Frequency Change-Over 1</i> 66	<i>Fixed Frequency Change-Over 2</i> 67	Function / active fixed value
0	0	Fixed Frequency 1 480
1	0	Fixed Frequency 2 481
1	1	Fixed Frequency 3 482
0	1	Fixed Frequency 4 483

0 = contact open 1 = contact closed



Additional fixed frequencies can be selected if an optional extension module featuring digital inputs is installed. In this case, follow the instructions on the optional extension module.

15.6.2 JOG-Frequency

The JOG function forms part of the functions for controlling the drive mechanism via the control unit. Use the arrow keys to change the JOG frequency within the function. The frequency of the output signal is set to the entered value if the FUN key is pressed. The drive starts and the machine turns at the set *JOG-Frequency* **489**. If the JOG frequency has been changed using the arrow keys, this value is stored.

Parameter		Settings		
No.	Description	Min.	Max.	Default
489	JOG-Frequency	-599.00 Hz	599.00 Hz	5.00 Hz

15.6.3 Fixed Percentages

The four percentage values define reference values which are selected via the parameters *Fixed Percent Change-Over 1* **75** and *Fixed Percent Change-Over 2* **76**. The parameter *Reference Percentage Source* **476** defines the addition of the various sources in the reference percentage channel.

Parameter		Settings		
No.	Description	Min.	Max.	Default
520	Fixed Percentage 1	-300.00 %	300.00 %	0.00 %
521	Fixed Percentage 2	-300.00 %	300.00 %	20.00 %
522	Fixed Percentage 3	-300.00 %	300.00 %	50.00 %
523	Fixed Percentage 4	-300.00 %	300.00 %	100.00 %

By combining the logic states of the fixed percentage change-over modes 1 and 2, fixed frequencies 1 through 4 can be selected:

Fixed Percentage Control		
<i>Fixed percentage value change-over 1</i> 75	<i>Fixed percentage value change-over 2</i> 76	Function / active fixed value
0	0	Fixed Percentage 1 520
1	0	Fixed Percentage 2 521
1	1	Fixed Percentage 3 522
0	1	Fixed Percentage 4 523

0 = contact open 1 = contact closed

15.7 Frequency ramps

The ramps determine how fast the frequency value is changed if the reference value changes or after a start, stop or brake command. The maximum admissible ramp gradient can be selected according to the application and the current consumption of the motor.

If the settings of the frequency ramps are identical for both directions of rotation, the parameterization via the parameters *Acceleration (Clockwise)* **420** and *Deceleration (Clockwise)* **421** is sufficient. The values of the frequency ramps are taken over for *Acceleration Anticlockwise* **422** and *Deceleration Anticlockwise* **423** if these have been parameterized to the factory setting of -0.01 Hz/s.

The parameter value of 0.00 Hz/s for the acceleration blocks the corresponding direction of rotation.

Parameter		Settings		
No.	Description	Min.	Max.	Default
420	Acceleration (Clockwise)	0.00 Hz/s	9999.99 Hz/s	5.00 Hz/s
421	Deceleration (Clockwise)	0.01 Hz/s	9999.99 Hz/s	5.00 Hz/s
422	Acceleration Anticlockwise	- 0.01 Hz/s ¹⁾	9999.99 Hz/s	-0.01 Hz/s
423	Deceleration Anticlockwise	- 0.01 Hz/s ²⁾	9999.99 Hz/s	-0.01 Hz/s

¹⁾ Value -0.01 Hz/s means: *Acceleration (Clockwise)* **420** is applied.

²⁾ Value -0.01 Hz/s means: *Deceleration (Clockwise)* **421** is applied.



The setting 0.00 Hz/s won't accelerate or decelerate the drive due to the limitation of the ramp.

The ramps for *Emergency Stop Clockwise* **424** and *Emergency Stop Anticlockwise* **425** of the drive to be activated via the parameter for stopping behavior *Operation Mode* **630** must be selected according to the application. The non-linear (S-shaped) course of the ramps is not active in the case of an emergency stop of the drive.

Parameter		Settings		
No.	Description	Min.	Max.	Default
424	Emergency Stop Clockwise	0.01 Hz/s	9999.99 Hz/s	5.00 Hz/s
425	Emergency Stop Anticlockwise	0.01 Hz/s	9999.99 Hz/s	5.00 Hz/s

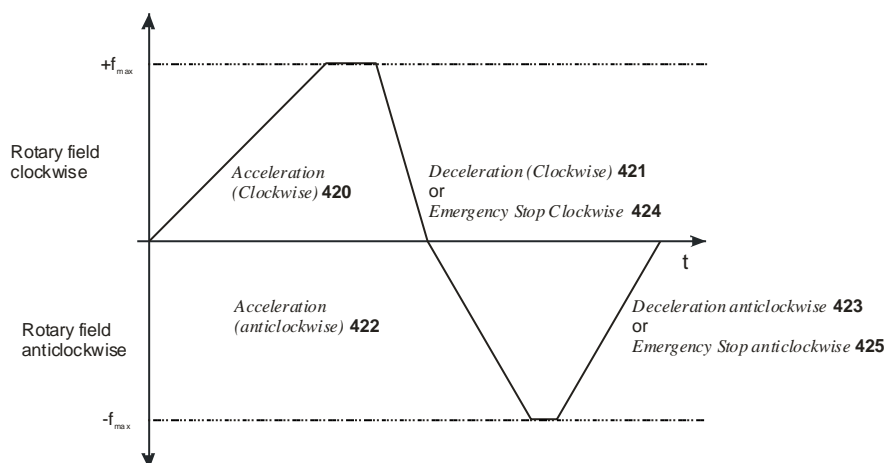

The parameter *Maximum Leading* **426** limits the difference between the output of the ramp and the current actual value of the drive. The set maximum deviation is a dead time for the control system which should be kept as low as possible.

In case the drive is loaded heavily and high acceleration and deceleration values are selected it is possible, that a set controller limit is reached while the drive is accelerated or decelerated. In this case, the drive cannot follow the defined acceleration or deceleration ramps. With *Maximum Leading* **426**, you can limit the max. leading of the ramp.

Parameter		Settings		
No.	Description	Min.	Max.	Default
426	Maximum Leading	0.01 Hz	599.00 Hz	5.00 Hz

Example: Fixed value at ramp output = 20 Hz, current actual value of drive = 15 Hz, selected *Maximum Leading* **426** = 5 Hz

The frequency at the ramp output is increased to 15 Hz only and it is not increased further. The difference (leading) between the frequency value at the ramp output and the current actual frequency of the drive is limited to 5 Hz in this way.

The load occurring in a linear acceleration of the drive is reduced by the adjustable modification speeds (S curve). The non-linear course of the frequency is defined as a ramp and states the time range in which the frequency is to be guided to the set ramp. The values set with parameters 420 to 423 are maintained regardless of the selected ramp times.

Setting the ramp time to 0 ms deactivates the function S curve and enables the use of the linear ramps. The data set change-over of the parameters within an acceleration phase of the drive demands the defined take-over of the values. The controller calculates the values required in order to reach the reference value from the ratio of the acceleration to the ramp time and uses it until the acceleration phase is finished. With this method, exceeding the reference values is avoided and a data set change-over between extremely deviating values becomes possible.

Parameter		Settings		
No.	Description	Min.	Max.	Default
430	Ramp Rise Time Clockwise	0 ms	65000 ms	0 ms
431	Ramp Fall Time Clockwise	0 ms	65000 ms	0 ms
432	Ramp Rise Time Anticlockwise	0 ms	65000 ms	0 ms
433	Ramp Rise Time Anticlockwise	0 ms	65000 ms	0 ms

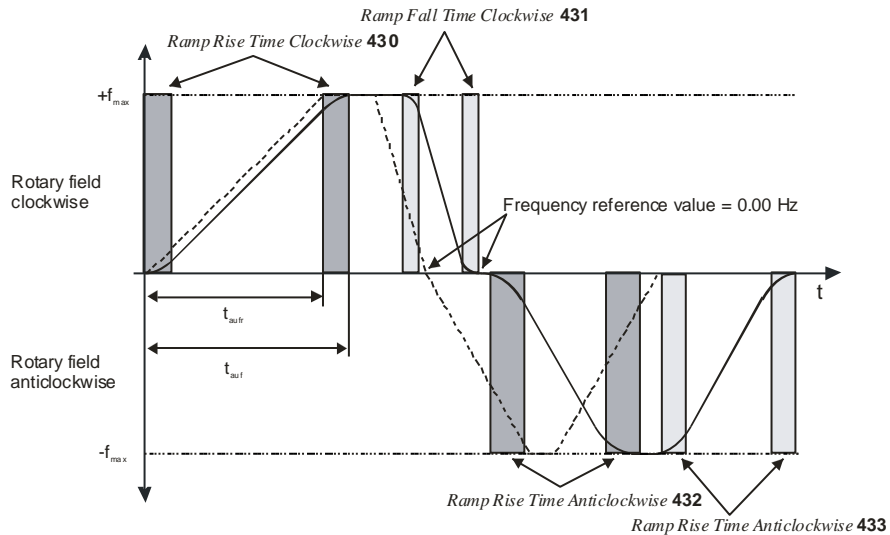

Example:

Calculation of the acceleration time in clockwise rotation at an acceleration from 20 Hz to 50 Hz (fmax) and an acceleration ramp of 2 Hz/s for parameter *Acceleration (Clockwise)* **420**. The parameter *Ramp Rise Time Clockwise* **430** is set to 100 ms.

$$t_{\text{aufr}} = \frac{\Delta f}{a_r}$$

$$t_{\text{aufr}} = \frac{50 \text{ Hz} - 20 \text{ Hz}}{2 \text{ Hz/s}} = 15 \text{ s}$$

$$t_{\text{auf}} = t_{\text{aufr}} + t_{\text{vr}}$$

$$t_{\text{auf}} = 15 \text{ s} + 100 \text{ ms} = 15.1 \text{ s}$$

t_{aufr} = acceleration time
clockwise rotary field

Δf = change of frequency
acceleration ramp

a_r = Acceleration
Clockwise

Ramp Rise Time Clockwise

t_{vr} = acceleration time +
ramp rise time

t_{auf} =

15.8 Percentage Value Ramps

The percentage value ramps scale the change of the reference value (in percent) for the corresponding input function. The acceleration and deceleration of the drive are parameterized via the frequency ramps.

The behavior *Gradient Percentage Ramp* **477** corresponds to a function which takes the time response of the drive system into account. If the parameter is set to 0 %/s, this function is deactivated and a direct reference value modification for the following function is obtained.

The default value depends on the parameter *Configuration* **30**.

Parameter		Settings		
No.	Description	Min.	Max.	Default
477	Gradient Percentage Ramp	0 %/s	60.000 %/s	x %/s

15.9 Block Frequencies

In certain applications, it is necessary to fade out reference frequencies. In this way, resonance points of the system as stationary operating points are avoided. The parameters *1st Blocking Frequency* **447** and *2nd Blocking Frequency* **448** with the parameter *Frequency Hysteresis* **449** define two resonance points.

A block frequency is active if the parameter values of the block frequency and the frequency hysteresis are not equal to 0.00 Hz.

The area faded out as a stationary working point by the hysteresis is passed through as quickly as possible according to the selected ramp for V. If the output frequency is limited as a result of the selected control parameter settings, e.g., if the current limit is reached, the hysteresis is passed through with a delay. The behavior of the reference value can be determined from its direction of movement according to the following diagram.

Parameter		Settings		
No.	Description	Min.	Max.	Default
447	1st Blocking Frequency	0.00 Hz	599.00 Hz	0.00 Hz
448	2nd Blocking Frequency	0.00 Hz	599.00 Hz	0.00 Hz
449	Frequency Hysteresis	0.00 Hz	100.00 Hz	0.00 Hz

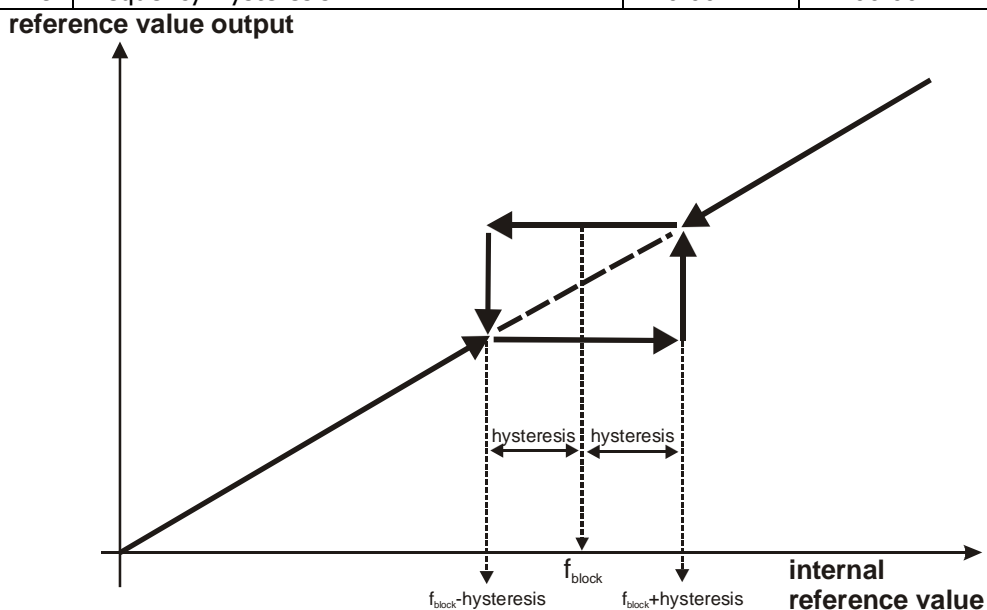

15.10 Motor Potentiometer

The motor potentiometer is used for controlling the motor speed using

- digital control signals (Function Motorpoti MP) or
- the keys of the KP 500 control unit (Function Motorpoti KP)

The following functions are assigned to the Up/Down control commands:

Activation				
Motorpoti (MP)		Motorpoti (KP)		Function
Up	Down	Up	Down	
0	0	–	–	Output signal does not change.
1	0	▲	–	Output value rises at set ramp.
0	1	–	▼	Output value drops at set ramp.
1	1	▲ + ▼		Output value is reset to initial value.

0 = contact open 1 = contact closed

▲ ▼ = arrow keys at KP 500 control unit

The motor potentiometer function as well as its assignment to other reference value sources can be selected in the corresponding reference value channels via parameters Reference Frequency Source **475** or Reference Percentage Source **476**.

Refer to chapters 15.4 "Frequency Reference Channel" and 15.5 "Reference Percentage Channel" for the possible reference value source assignments.

The availability of the functions "Motorpoti (MP)" and "Motorpoti (KP)" varies in the different reference value channels:

	Reference value channel	
	Reference Frequency Source 475	Reference Percentage Source 476
Motorpoti (MP)	X	X
Motorpoti (KP)	X	0

X = Function available 0 = Function not available

Depending on the active reference value channel, the function is assigned to a digital signal via parameters *Frequency Motorpoti Up* **62**, *Frequency Motorpot. Down* **63** or *Percent Motorpo. Up* **72**, *Percent Motorpoti Down* **73**.

Refer to chapter 16.4 "Digital Inputs" for a list of the available digital signals.

The *Operation Mode 474* of the motor potentiometer function defines the behavior of the function at various operating points of the frequency inverter.

<i>Operation Mode 474</i>	Function
0 - Not Latching	In the operation mode motor potentiometer non-storing (not latching), the drive goes to the set minimum reference value at each start.
1 - latching	In the operation mode storing (latching) the motor goes to the reference value selected before the switch-off at the start. The reference value is also stored when the device is switched off.
2 - Taking Over	The operation mode Motorpoti taking over is to be used for the data set change-over of the reference value channel. The current reference value is used by changing to the motorpoti function.
3 - Taking Over and Latching	This operation mode combines the behavior in operation mode 1 and 2.

15.10.1 Motorpoti (MP)

The Function "Motorpoti (MP)" can be parameterized via the parameters *Reference Frequency Source 475* or *Reference Percentage Source 476*.

Frequency Reference Channel

Via the digital control inputs, the required functions *Frequency Motorpoti Up 62* and *Frequency Motorpot. Down 63* are activated.

The reference values are limited via parameters *Minimum Frequency 418* and *Maximum Frequency 419*.

Reference percentage channel

Via the digital control inputs, the required functions *Percentage Motorpoti Up 72* and *Percentage Motorpot. Down 73* are activated. The reference values are limited via parameters *Minimum Percentage 518* and *Maximum Percentage 519*.

15.10.2 Motorpoti (KP)

The function "Motorpoti (KP)" is only available in the reference frequency channel. The function and its assignment to other reference value sources can be selected via parameter *Reference Frequency Source 475*.

Via the keys of the KP 500 control unit, the required functions *Frequency Motorpoti Up 62* and *Frequency Motorpot. Down 63* are activated.

The reference values are limited via parameters *Minimum Frequency 418* and *Maximum Frequency 419*.

The function is used as described in chapter 15.10.3 "Controlling the Motor via the Control Unit".

When the function Motorpoti (KP) is active "inPF" will be displayed for clockwise operation and "inPr" will be displayed for anti-clockwise operation.

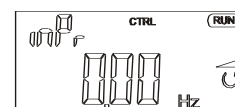
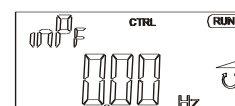

The control unit keys have the following functions:

Key functions	
▲ / ▼	Increase / reduce frequency.
ENT	Reversal of the direction of rotation independent of the control signal on the terminals Clockwise S2IND or Anticlockwise S3IND.
ENT (1 sec)	Save the selected function as default value. The direction of rotation is not exchanged.
ESC	Cancel function and return to the menu structure.
FUN	Switch from internal set point inP to JOG frequency; the drive starts. Release the key to switch to the sub-function and stop the drive.
RUN	Start drive; alternative to control signal S2IND or S3IND.
STOP	Stop drive; alternative to control signal S2IND or S3IND.

15.10.3 Controlling the Motor via the Control Unit

The parameter Reference Frequency Source **475** enables the assignment of the reference value sources in the frequency reference value channel. Operation modes can be set without the function "Motorpoti (KP)".

If an operation mode is selected without "Motorpoti (KP)", it is still possible to control a connected motor via the keys of the KP 500 control unit.

The function is activated as described in "Control Unit KP500, Controlling the Motor via the Control Unit".

The speed of the modification of the reference value is limited by the parameter *Ramp Keypad-Motorpoti* **473**.

Parameter		Settings		
No.	Description	Min.	Max.	Default
473	Ramp Keypad-Motorpoti	0.00 Hz/s	999.99 Hz/s	2.00 Hz/s

15.11 Repetition frequency input

The use of a frequency signal completes the various possibilities of the reference value specification. The signal at one of the available digital inputs is evaluated according to the selected *Operation Mode* **496**.

Operation Mode 496		Function
0 -	Off	Repetition frequency is zero.
21 -	S2IND Single Evaluation pos.	One edge of the frequency signal at terminal X210A.4 is evaluated with a positive sign.
22 -	S2IND Double Evaluation pos.	Both edges of the frequency signal at terminal X210A.4 are evaluated with a positive sign.
31 -	S3IND Single Evaluation pos.	One edge of the frequency signal at terminal X210A.5 is evaluated with a positive sign.
32 -	S3IND Double Evaluation pos.	Both edges of the frequency signal at terminal X210A.5 are evaluated with a positive sign.
61 -	S6IND Single Evaluation pos.	One edge of the frequency signal at terminal X210B.1 is evaluated with a positive sign.
62 -	S6IND Double Evaluation pos.	Both edges of the frequency signal at terminal X210B.1 are evaluated with a positive sign.
121 to 162		Operation modes 21 to 62 with evaluation of the frequency signal, but with a negative sign.



If a digital input is configured as a repetition frequency input, this input cannot be used for other functions.

Check the link of the digital inputs to other functions.

The signal frequency at the selected repetition frequency input can be scaled via the parameter *Divider* **497**. The parameter figure is comparable with the division marks of a speed sensor per rotation of the drive. The frequency limit of the parameterized digital input is to be taken into account for the frequency of the input signal.

Parameter		Settings		
No.	Description	Min.	Max.	Default
497	Divider	1	8192	1024



The reference value specification within the different functions enables the use of the repetition frequency signal as a percentage figure. A signal frequency of 100 Hz at the repetition frequency input corresponds to 100%, 1 Hz corresponds to 1%. The parameter *Divider* **497** is to be used in a way comparable with the speed sensor simulation.

16 Control Inputs and Outputs

The modular structure of the frequency inverters enables a wide spectrum of applications on the basis of the available hardware and software functionality. The control inputs and outputs of terminals X210A and X210B described in the following can be linked to software modules freely via the described parameters.

16.1 Multi-function input MFI1

Multifunction input MFI1 can either be configured as a voltage, current or a digital input. Depending on the selected *Operation Mode* **452** for the multifunction input, a link to various functions of the software is possible. The unused operation modes are assigned the signal value 0 (LOW).

<i>Operation mode</i> 452		Function
1 -	Voltage Input	voltage signal (MFI1A), 0 V ... 10 V
2 -	Current Input	current signal (MFI1A), 0 mA ... 20 mA
3 -	Digital Input	digital signal (MFI1D), 0 V ... 24 V



The sampling rate of multi-function input MFI1D is slower than that of digital signals S1IND, S2IND, etc. For this reason, this input should only be used for signals which are **not time-critical**.

16.1.1 Analog Input MFI1A

Multifunction input MFI1 is configured by default for an analog reference value source with a voltage signal of 0 V to 10 V.

Alternatively, you can select the operation mode for an analog current signal of 0 mA to 20 mA. The current signal is continuously monitored and the fault message "F1407" displayed if the maximum figure is exceeded.

16.1.1.1 Characteristic

Mapping of the analog input signal onto a reference frequency value or a reference percentage value is possible for various requirements. Parameterization can be done via two points of the linear characteristic of the reference value channel.

Point 1 with coordinates X1 and Y1 and point 2 with coordinates X2 and Y2 can be set in four data sets.

Parameter		Settings		
No.	Description	Min.	Max.	Default
454	Point X1	0.00 %	100.00 %	2.00 %
455	Point Y1	-100.00 %	100.00 %	0.00 %
456	Point X2	0.00 %	100.00 %	98.00 %
457	Point Y2	-100.00 %	100.00 %	100.00 %

The coordinates of the points relate, as a percentage, to the analog signal with 10 V or 20 mA and parameter *Maximum Frequency* **419** or parameter *Maximum Reference Percentage* **519**. The direction of rotation can be changed via the digital inputs and/or by selection of the points.



The monitoring of the analog input signal via the parameter *Error/Warning Behavior* **453** demands the examination of the parameter *Point X1* **454**.

The following characteristic is set by default and can be adapted to the application via the parameters mentioned.

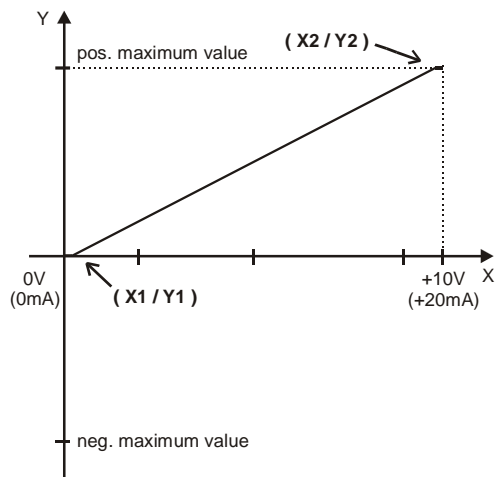

Point 1:
 $X1 = 2.00\% \cdot 10 \text{ V} = 0.20 \text{ V}$
 $Y1 = 0.00\% \cdot 50.00 \text{ Hz} = 0.00 \text{ Hz}$

Point 2:
 $X2 = 98.00\% \cdot 10 \text{ V} = 9.80 \text{ V}$
 $Y2 = 100.00\% \cdot 50.00 \text{ Hz} = 50.00 \text{ Hz}$

The freely configurable characteristic enables setting a tolerance at the ends as well as a reversal of the direction of rotation.

The following example shows the inverse reference value specification with additional reversal of the direction of rotation. This is often used in pressure control systems.

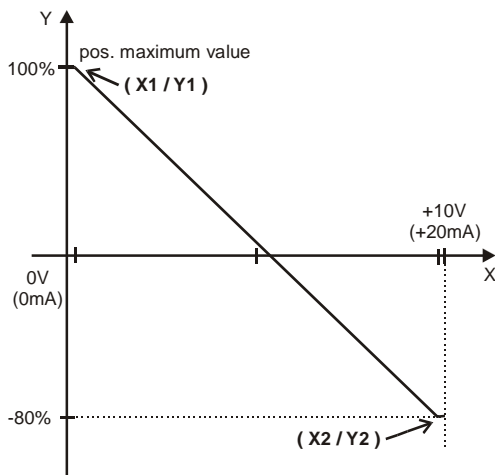

Point 1:
 $X1 = 2.00\% \cdot 10 \text{ V} = 0.20 \text{ V}$
 $Y1 = 100.00\% \cdot 50.00 \text{ Hz} = 50.00 \text{ Hz}$

Point 2:
 $X2 = 98.00\% \cdot 10 \text{ V} = 9.80 \text{ V}$
 $Y2 = -80.00\% \cdot 50.00 \text{ Hz} = -40.00 \text{ Hz}$

The reversal of the direction of rotation is effected in this example at an analog input signal of 5.5V.

The definition of the analog input characteristic can be calculated via the two-point form of the line equation. The speed Y of the drive is controlled according to the analog control signal X.

$$Y = \frac{Y2 - Y1}{X2 - X1} \cdot (X - X1) + Y1$$

16.1.1.2 Scaling

The analog input signal is mapped to the freely configurable characteristic. The maximum admissible setting range of the drive can be set via the frequency limits or percentage limits according to the configuration selected. In the case of the parameterization of a bipolar characteristic, the set minimum and maximum limits for both directions of rotation are effective. The percentage values of the characteristic points are relative to the limits selected.

Parameter		Settings		
No.	Description	Min.	Max.	Default
418	Minimum Frequency	0.00 Hz	599.00 Hz	3.50 Hz ¹⁾ 0.00 Hz ²⁾
419	Maximum Frequency	0.00 Hz	599.00 Hz	50.00 Hz

The factory settings depend on the setup of parameter *Configuration* **30**:

¹⁾ 3.50 Hz in configurations 1xx, 4xx

²⁾ 0.00 Hz in configurations 2xx, 5xx

The control system uses the maximum value of the output frequency, which is calculated from the *Maximum Frequency* **419** and the compensated slip of the drive. The frequency limits define the speed range of the drive, and the percentage values supplement the scaling of the analog input characteristic in accordance with the functions configured.

Parameter		Settings		
No.	Description	Min.	Max.	Default
518	Minimum Reference Percentage	0.00 %	300.00 %	0.00 %
519	Maximum Reference Percentage	0.00 %	300.00 %	100.00 %

16.1.1.3 Tolerance Band and Hysteresis

The analog input characteristic with change of sign of the reference value can be adapted by the parameter *Tolerance Band* **450** of the application. The adjustable tolerance band extends the zero passage of the speed relative to the analog control signal. The parameter value (percent) is relative to the maximum current or voltage signal.

Parameter		Settings		
No.	Description	Min.	Max.	Default
450	Tolerance Band	0.00 %	25.00 %	2.00 %

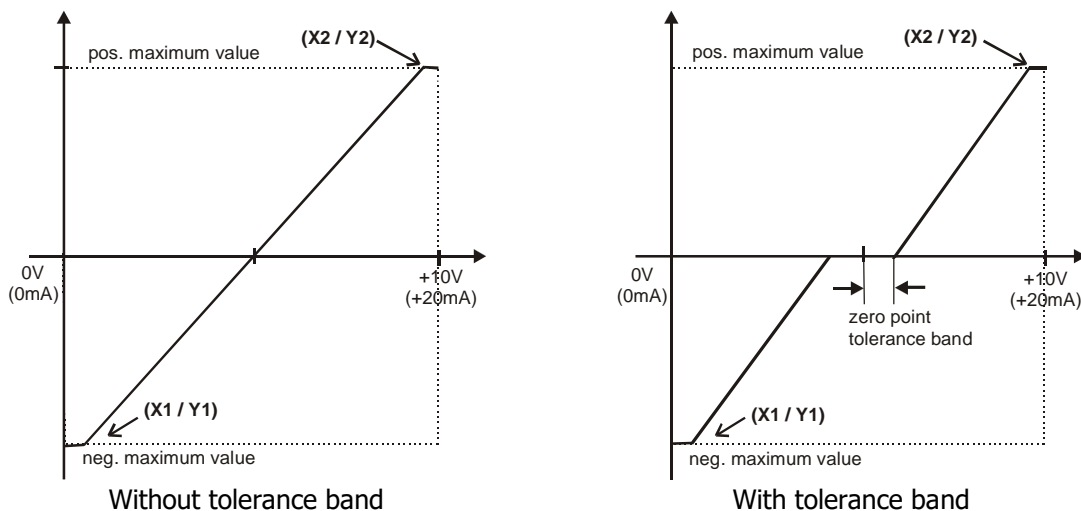

The default *Minimum Frequency* **418** or *Minimum Percentage* **518** extends the parameterized tolerance band to the hysteresis.

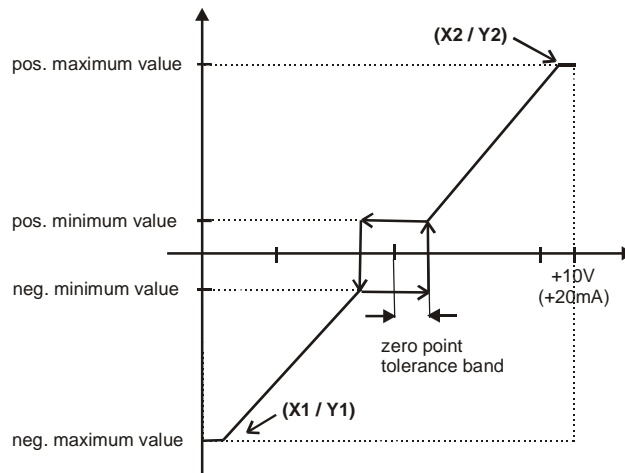

Tolerance band with set maximum frequency

For example, the output variable coming from positive input signals is kept on the positive minimum value until the input signal becomes lower than the value for the tolerance band in the negative direction. Then, the output variable follows the set characteristic.

16.1.1.4 Filter Time Constant

The time constant of the filter for the analog reference value can be set via the parameter *Filter Time Constant* **451**.

The time constant indicates the time during which the input signal is averaged by means of a low pass filter, e.g. in order to eliminate fault effects.

The setting range is between 0 ms and 5000 ms in 15 steps.

<i>Filter Time Constant</i> 451	Function
0 - Time Constant 0 ms	Filter deactivated – analog reference value is forwarded unfiltered.
2 - Time Constant 2 ms	Filter activated – averaging of the input signal via the set value of the filter time constants.
4 - Time Constant 4 ms	
8 - Time Constant 8 ms	
16 - Time Constant 16 ms	
32 - Time Constant 32 ms	
64 - Time Constant 64 ms	
128 - Time Constant 128 ms	
256 - Time Constant 256 ms	
512 - Time Constant 512 ms	
1000 - Time Constant 1000 ms	
2000 - Time Constant 2000 ms	
3000 - Time Constant 3000 ms	
4000 - Time Constant 4000 ms	
5000 - Time Constant 5000 ms	

16.1.1.5 Error and warning behavior

For monitoring the analog input signal, an operation mode can be selected via parameter *Error/Warning Behavior* **453**.

<i>Error/Warning Behavior</i> 453	Function
0 - Off	The input signal is not monitored.
1 - Warning < 1V/2mA	If the input signal is lower than 1 V or 2 mA, a warning message is issued.
2 - Shut Down < 1V/2mA	If the input signal is lower than 1 V or 2 mA, a warning message is issued; the drive is decelerated according to stopping behavior 2.
3 - Error Switch-Off < 1V/2mA	If the input signal is lower than 1 V or 2 mA, a warning and fault message is issued and the drive coasts to a standstill (stopping behavior 0).

Monitoring of the analog input signal is active regardless of the release of the frequency inverter according to the operation mode selected.

Operation mode 2 defines the shut-down and stopping of the drive, regardless of the setting of parameter *Operation Mode* **630** for the stopping behavior. The drive is stopped according to stopping behavior 2. If the set holding time has expired, an error message is issued. The drive can be started again by switching the start signal on and off.

Operation mode 3 defines the free coasting of the drive (like described for stopping behavior 0), regardless of the setting of parameter *Operation Mode* **630** for the stopping behavior.



The monitoring of the analog input signal via the parameter *Error/Warning Behavior* **453** demands the examination of the parameter *Point XI* **454**.

Example: *Error/Warning Behavior* **453** = "2 - Shut Down < 1V/2mA" or "3 - Error Switch-Off < 1V/2mA". In the factory setting of parameter *Point XI* **454** shut down or error switch-off is activated at an output frequency unequal to 0 Hz. If shut down or error switch-off should be activated at an output frequency equal to 0 Hz the parameter *Point XI* **454** must be adjusted (e.g. X1=10% / 1 V).

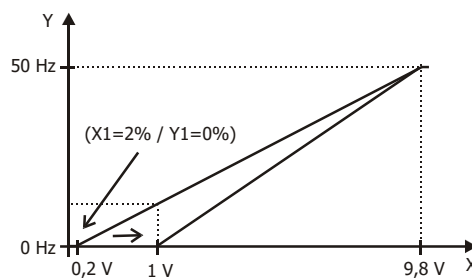

16.2 Multi-function output MFO1

Multifunction output MFO1 can either be configured as a digital, analog or a repetition frequency output. Depending on the selected *Operation mode* **550** for the multifunction output, a link to various functions of the software is possible. The operation modes not used are deactivated internally.

<i>Operation mode</i> 550	Function
0 - Off	Output has the logic signal LOW.
1 - Digital	Digital output, 0 ... 24 V.
2 - Analog	Analog output, 0 ... 24 V.
3 - Repetition frequency	Repetition frequency output, 0 ... 24 V, $f_{max} = 150$ kHz.

16.2.1 Analog Output MFO1A

By default, the multifunction output MFO1 is configured for the output of a pulse width modulated output signal with a maximum voltage of DC 24 V.

The selected configuration determines which actual values can be selected for parameter *Analog Operation* **553** of multifunction output 1.

Analog operation 553	Function
0 - Off	Analog operation MFO1 is switched off.
1 - Abs. Fs	Absolute value of stator frequency 1, 0.00 Hz ... <i>Maximum Frequency</i> 419 .
2 - Abs. Fs betw. fmin/fmax	Absolute value of stator frequency, <i>Minimum Frequency</i> 418 ... <i>Maximum Frequency</i> 419 .
3 - Abs. Speed Sensor 1	Absolute value of speed sensor signal 1, 0.00 Hz ... <i>Maximum Frequency</i> 419 .
7 - Abs. Actual Frequency	Absolute value of actual frequency, 0.00 Hz ... <i>Maximum Frequency</i> 419 .
20 - Abs. Iactive	Absolute value of current active current I_{ACTIVE} , 0.0 A ... FU rated current.
21 - Abs. Isd	Abs. value of flux-forming current component, 0.0 A ... FU rated current.
22 - Abs. Isq	Abs. value of torque-forming current component, 0.0 A ... FU rated current.
30 - Abs. Pactive	Absolute value of current active power P_{ACTIVE} , 0.0 kW ... <i>Rated Power</i> 376 .
31 - Abs. M	Absolute value of calculated torque M, 0.0 Nm ... rated torque.
32 - Abs. Inside Temperature	Abs. value of measured inside temperature, 0 °C ... 100 °C.
33 - Abs. Heat Sink Temperature	Abs. value of measured heat sink temperature, 0 °C ... 100 °C.
40 - Abs. Analog Input MFI1A	Absolute signal value at analog input 1, 0.0 V ... 10.0 V.
50 - Abs. I	Absolute current value of the measured output currents, 0.0 A ... FU rated current.
51 - DC link voltage	DC link voltage U_d , 0.0 V ... 1000.0 V.
52 - V	Output voltage V, 0.0 V ... 1000.0 V.
53 - Volume Flow	Absolute value of calculated volumetric flow 0.0 m ³ /h ... <i>Nominal Volumetric Flow</i> 397 .
54 - Pressure	Absolute value of calculated pressure 0.0 kPa ... <i>Nominal Pressure</i> 398 .
101 to 133	Operation modes in analog operation with signs.

16.2.1.1 Output Characteristic

The voltage range of the output signal at multifunction output 1 can be adjusted. The value range of the actual value selected via parameter *Analog Operation* **553** is assigned to the value range of the output signal which is adjusted via the parameters *Voltage 100%* **551** and *Voltage 0%* **552**.

Parameter		Settings		
No.	Description	Min.	Max.	Default
551	Voltage 100%	0.0 V	22.0 V	10.0 V
552	Voltage 0%	0.0 V	24.0 V	0.0 V

Actual abs. value *Analog Operation* **553**:

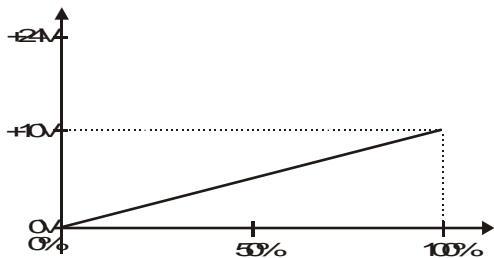

Analog Operation **553** with signs:

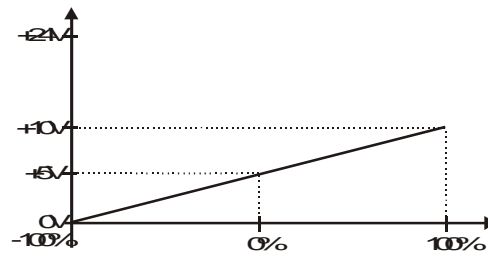

With the parameters *Voltage 100%* **551** and *Voltage 0%* **552**, the voltage range at 100% and 0% of the output parameter is set. If the output value exceeds the reference value, the output voltage also exceeds the value of the parameter *Voltage 100%* **551** up to the maximum value of 24V.

16.2.2 Frequency Output MFO1F

The multifunctional output MFO1 can be used as a frequency output if the corresponding *Operation Mode* **550** is selected. The 24V output signal is assigned to the abs. value of the speed or frequency via the parameter *Repetition Freq. Operation* **555**. The selection of the operation modes depends on the expansion modules installed as an option.

<i>Repetition Freq. Operation</i> 555	Function
0 - Off	Repetition frequency operation MFO1 switched off.
1 - Actual Frequency	Abs. value of the <i>Actual Frequency</i> 241 .
2 - Stator Frequency	Abs. value of the <i>Stator Frequency</i> 210 .
3 - Frequency Speed Sensor 1	Abs. value of the <i>Encoder 1 Frequency</i> 217 .
5 - Repetition Frequency Input	Abs. value of the <i>Repetition Frequency Input</i> 252 .

16.2.2.1 Scaling

The repetition frequency mode for the multifunction output corresponds to the emulation of an incremental sensor. The parameter *Division Marks* **556** must be parameterized according to the frequency to be output.

Parameter		Settings		
No.	Description	Min.	Max.	Default
556	Division marks	30	8192	1024

The frequency limit of $f_{\max}=150$ kHz must not be exceeded in the calculation of the parameter *Division marks* **556**, i.e. the requirement

$S_{\max} * \text{abs. frequency value} * 150 \text{ kHz}$ must be met.

$$S_{\max} = \frac{150000 \text{ Hz}}{\text{Frequency value}}$$

16.3 Digital Outputs

The *OP. Mode Digital Output 1* **530** and the relay output with the parameter *Op. Mode Digital Output 3* **532** link the digital outputs to various functions. The selection of the functions depends on the parameterized configuration. The use of the multifunctional output MFO1 as a digital output demands selection of an *Operation Mode* **550** and linking via parameter *Digital Operation* **554**.

<i>Operation mode</i> 530,532,554	Function
0 - Off	Digital output is switched off.
1 - Ready or Standby Signal	Frequency inverter is initialized and on stand-by or in operation.
2 - Run Signal	Controller release signal and a start command are present, output frequency available.
3 - Error Signal	Message is displayed via the parameter <i>Current Error</i> 259 or <i>Warnings</i> 269 .
4 - Setting Frequency	The <i>Stator Frequency</i> 210 is higher than the parameterized <i>Setting Frequency</i> 510 .
5 - Reference Frequency reached	The <i>Actual Frequency</i> 241 of the drive has reached the <i>Internal Reference Frequency</i> 228 .
6 - Reference Percentage Reached	The <i>Actual Percentage Value</i> 230 has reached the <i>Reference Percentage Value</i> 229 .
7 - Ixt warning	The <i>Warning Limit Short-Term Ixt</i> 405 or <i>Warning Limit Long-Term Ixt</i> 406 has been reached.
8 - Warning Heat sink temperature	Max. heat sink temperature T_K of 80 °C minus the <i>Warning Limit Heat Sink Temp.</i> 407 reached.
9 - Warning Inside temperature	Max. inside temperature T_i of 65 °C minus the <i>Warning Limit Inside Temperature</i> 408 reached.
10 - Warning Motor Temperature	Warning behavior according to parameterized <i>Motor Temp. Operation Mode</i> 570 at max. motor temperature T_{PTC} .
11 - Warning General	The message is displayed via parameter <i>Warnings</i> 269 .
12 - Warning over temperature	The selected limit values <i>Warning Limit Heat Sink Temp.</i> 407 , <i>Warning Limit Inside Temp</i> 408 or the maximum motor temperature have been exceeded.
13 - Mains Failure	Failure of the mains voltage and power regulation active according to <i>Operation Mode</i> 670 for the voltage controller.
14 - Warning Motor Protect. Switch	Parameterized <i>Operation Mode</i> 571 for the motor protection switch has triggered.
15 - Warning Current Limitation	A controller or the <i>Operation Mode</i> 573 of the intelligent current limits limit the output current.
16 - Controller Current Limit. Long Term Ixt	The overload reserve for 60 s has been used up and the output current is being limited.
17 - Controller Current Limit. Short Term Ixt	The overload reserve for 1 s has been used up and the output current is being limited.
18 - Controller Current Limit. TK	Max. heat sink temperature T_K reached, intelligent current limits of <i>Operation Mode</i> 573 active.
19 - Controller Current Limit. Motor Temp.	Max. motor temperature reached, intelligent current limits of <i>Operation Mode</i> 573 active.
20 - Comparator 1	The comparison according to the selected <i>OP. mode Comparator 1</i> 540 is true.

Table "Operation Modes for Digital Outputs" continued on next page.

Operation mode	Function
21 - Comparator 2	The comparison according to the selected <i>OP. mode Comparator 2</i> 543 is true.
22 - Warning V-belt	Warning of <i>Operation Mode</i> 581 of V-belt monitoring.
23 - Timer 1	The selected <i>Operation Mode Timer 1</i> 790 generates an output signal of the function.
24 - Timer 2	The selected <i>Operation Mode Timer 2</i> 793 generates an output signal of the function.
25 - Warning Mask	Message of the configurable parameter <i>Create Warning Mask</i> 536 .
30 - Flux Formation Ended	Magnetic field has been impressed.
41 - Open brake	Activation of a brake unit depending on the <i>Operation Mode</i> 620 for the starting behavior, <i>Operation Mode</i> 630 for the stopping behavior or the configured brake control system.
43 - External Fan	The <i>Switch-On Temperature</i> 39 has been reached.
60 - Arrived at desired Position	<i>Reference orientation</i> 469 of axle positioning reached.
70 - Logic Function 1	Signal from output of logic module 1, according to parameterized <i>Operation Mode Logic 1</i> 198 .
71 - Logic Function 2	Signal from output of logic module 2, according to parameterized <i>Operation Mode Logic 2</i> 201 .
72 - Logic Function 3	Signal from output of logic module 3, according to parameterized <i>Operation Mode Logic 3</i> 205 .
73 - Logic Function 4	Signal from output of logic module 4, according to parameterized <i>Operation Mode Logic 4</i> 503 .
100 to 173	Operation modes inverted (LOW active).

16.3.1 Setting Frequency

If operation mode 4 is selected for a digital output, the corresponding output becomes active if the *Stator Frequency* **210** has exceeded the value set under the parameter *Setting Frequency* **510**.

The relevant output is switched over again as soon as the *Stator Frequency* **210** falls below the value selected for the setting frequency.

Parameter		Settings		
No.	Description	Min.	Max.	Default
510	Setting Frequency	0.00 Hz	599.00 Hz	3.00 Hz

16.3.2 Reference value reached

In operation mode 5 or 6 for a digital output, a message is generated via the corresponding output when the actual frequency or actual percentage value has reached the reference value.

The maximum deviation can be defined as a percentage of the adjustable range (Max - Min) via the parameter *Max. Control Deviation* **549**.

Parameter		Settings		
No.	Description	Min.	Max.	Default
549	Max. Control Deviation	0.01 %	20.00 %	5.00 %

16.3.3 Flux Formation Ended

If operation mode 30 is selected for a digital output, the corresponding output becomes active when the flux formation is ended. The time for the flux formation results from the operating state of the machine and the set parameters for magnetizing the machine. The magnetizing

can be defined via the starting behavior and is influenced by the amount of the set starting current.

16.3.4 Open brake

The Open brake function in operation mode 41 enables the activation of a corresponding unit via the digital control output. The function uses both the control commands via the contact inputs and the set starting and stopping behavior for controlling the digital output.

According to the configured starting behavior, the output is switched on when the magnetizing of the motor is finished. The brake is released and the drive is accelerated.

The stopping behavior of the drive depends on the configuration of the parameters *Operation Mode* **630**. This is described in chapter 13.2 "Stopping Behavior".

If stopping behavior 2 or 5 with stop function is selected, the drive is controlled to zero speed and the digital output is not switched off. In the other operation modes of the stop behavior, the control of the brake is possible. At the start of a free coasting of the drive, the digital output is switched off.

This is similar to the behavior in the case of the stopping behavior with shutdown. The drive is decelerated and supplied with current for the set holding time. Within the set holding time, the control output is switched off and thus the brake activated.

Control of Brake	
Stopping Behavior 0	Operation mode "41 - Open brake" switches off the digital output assigned to the function immediately. The mechanical brake is activated.
Stopping Behavior 1, 3, 4, 6, 7	Operation mode "41 - Open brake" switches off the digital output assigned to the function when <i>Switch-Off Threshold</i> 637 is reached. The mechanical brake is activated.
Stopping Behavior 2, 5	Operation mode "41 - Open brake" leaves the digital output assigned to the function switched on. The mechanical brake remains open.

16.3.5 Current Limitation

Operation modes 15 to 19 link the digital outputs and the relay output to the functions of the intelligent current limits. The reduction of power by the set figure in percent of the rated current depends on the selected operation mode. Accordingly, the event for intervention of the current limitation can be output via the operation modes of the digital outputs. If the function of the intelligent current limits is deactivated within the sensor-less control, operation modes 16 to 19 are switched off in the same way.

16.3.6 External Fan

Operation mode 43 enables the control of an external fan. Via the digital output, the fan is switched on if the controller is released and Start clockwise or Start anticlockwise are switched on, or if the *Switch-On Temperature* **39** for the internal fan was reached.

16.3.7 Warning Mask

The Warning mask signals via a digital signal if an afore configured warning applies. The configuration of the Warning mask is carried out via *Create warning mask* **536**. Warnings and controller status messages can be combined. This enables internal or external control using a common output signal. The display of *Warning* **269** and *Controller Status* **275** is not affected by the Warning mask.

Select a setting 1 ... 43 for message activation.

Select a setting 101 ... 143 for deactivation of a message.

<i>Create Warning Mask 536</i>	Function
0 - No Change	Configured warning mask is not modified.
1 - Activate everything	The warnings and controller status messages stated are linked in the warning mask.
2 - Activate all Warnings	The warnings reports stated are linked in the warning mask.
3 - Activate all Controller States	The controller status reports stated are linked in the warning mask.
10 - Warning Ixt	The frequency inverter is overloaded.
11 - Warning Short-Term Ixt	Overload reserve for 1 s minus the <i>Warning Limit Short-Term Ixt 405</i> has been reached.
12 - Warning Long-Term Ixt	Overload reserve for 60 s minus the <i>Warning Limit Long-Term Ixt 406</i> has been reached.
13 - Warning Heat Sink Temperature	Max. heat sink temperature T_K of 80 °C minus the <i>Warning Limit Heat Sink Temperature 407</i> has been reached.
14 - Warning Inside Temperature	Max. inside temperature T_i of 65 °C minus the <i>Warning Limit Inside Temperature 408</i> reached.
15 - Warning Limit	The controller stated in <i>Controller Status 355</i> limits the reference value.
16 - Warning Init	Frequency inverter is initialized.
17 - Warning Motor Temperature	Warning behavior according to parameterized <i>Motor Temp. Operation Mode 570</i> at max. motor temperature T_{PTC} .
18 - Warning Phase Failure	<i>Phase Supervision 576</i> reports a phase failure.
19 - Warning Motor Protection Switch	<i>Operation Mode 571</i> for the motor protective switch has triggered.
20 - Warning Fmax	The <i>Maximum Frequency 419</i> has been exceeded. The frequency limitation is active.
21 - Warning Analog Input MFI1A	The input signal is lower than 1V/2mA according to the operation mode <i>Error/Warning Behavior 453</i> .
22 - Warning Analog Input EM-S1INA	The input signal is lower than 1V/2mA according to the operation mode <i>Error/Warning Behavior 453</i> .
23 - Warning System bus	A Slave at the system bus signals a fault; Warning is only relevant with option EM-SYS.
24 - Warning Udc	The DC link voltage has reached the type-dependent minimum value.
25 - Warning V-belt	The <i>Operation Mode 581</i> for V-belt monitoring signals no-load operation of the application.
30 - Controller Udc Dynamic Operation	Controller is active according to the <i>Operation Mode 670</i> for the voltage controller.
31 - Controller Shutdown	The output frequency in the case of a mains failure is below the <i>Shutdown Threshold 675</i> .
32 - Controller Mains Failure	Failure of the mains voltage and power regulation active according to <i>Operation Mode 670</i> for the voltage controller.

Operation mode		Function
33 -	Controller Udc Limitation	The DC link voltage has exceeded the <i>Reference DC-Link Limitation</i> 680 .
34 -	Controller Voltage Pre-Control	The <i>Dyn. Voltage Pre-Control</i> 605 accelerates the control characteristics.
35 -	Controller I abs	The output current is limited.
36 -	Controller Torque Limitation	The output power or the torque is limited on the speed controller.
37 -	Controller Torque Control	Switch-over of field-orientated control between speed and torque-controlled.
38 -	Ramp Stop	The <i>Operation Mode</i> 620 selected in starting behavior limits the output current.
39 -	Contr. Intel. Curr. Lim. LT-Ixt	Overload limit of the long-term Ixt (60s) reached, intelligent current limits active.
40 -	Contr. Intel. Curr. Lim. ST-Ixt	Overload limit of the short-term Ixt (1s) reached, intelligent current limits active.
41 -	Contr. Intel. Curr. Lim. Tc	Max. heat sink temperature T_K reached, <i>Operation Mode</i> 573 for the intelligent current limits active.
42 -	Contr. Intel. Curr. Lim. Motor Temp.	Max. motor temperature T_{PTC} reached, <i>Operation Mode</i> 573 for the intelligent current limits active.
43 -	Controller Torque Limitation	The reference frequency has reached the <i>Maximum Frequency</i> 419 . The frequency limitation is active.
101 to 143		Removal or deactivation of the operation mode within the warning mask.

The selected warning mask can be read out via parameter *Actual Warning Mask* **537**. The above operation modes of parameter *Create Warning Mask* **536** are encoded in the *Actual Warning Mask* **537**. The code is calculated by hexadecimal addition of the individual operation modes and the corresponding abbreviation.

Warning code				Operation mode 536
A	FFFF	FFFF	-	1 - Activate everything
A	0000	FFFF	-	2 - Activate all Warnings
A	FFFF	0000	-	3 - Activate all Controller States
A	0000	0001	Ixt	10 - Warning Ixt
A	0000	0002	IxtSt	11 - Warning Short-Term Ixt
A	0000	0004	IxtLt	12 - Warning Long-Term Ixt
A	0000	0008	Tc	13 - Warning Heat Sink Temperature
A	0000	0010	Ti	14 - Warning Inside Temperature
A	0000	0020	Lim	15 - Warning Limit
A	0000	0040	INIT	16 - Warning Init
A	0000	0080	MTemp	17 - Warning Motor Temperature
A	0000	0100	Mains	18 - Warning Phase Failure
A	0000	0200	PMS	19 - Warning Motor Protection Switch
A	0000	0400	Flim	20 - Warning Fmax
A	0000	0800	A1	21 - Warning Analog Input MFI1A
A	0000	1000	A2	22 - Warning Analog Input MFI2A
A	0000	2000	Sysbus	23 - Warning System bus
A	0000	4000	UDC	24 - Warning Udc
A	0000	8000	BELT	25 - Warning V-belt
A	0001	0000	UDdyn	30 - Controller Udc Dynamic Operation
A	0002	0000	UDstop	31 - Controller Shutdown
A	0004	0000	UDctr	32 - Controller Mains Failure
A	0008	0000	UDlim	33 - Controller Udc Limitation

Warning code				Operation mode 536	
A	0010	0000	Boost	34 -	Controller Voltage Pre-Control
A	0020	0000	Ilim	35 -	Controller I abs
A	0040	0000	Tlim	36 -	Controller Torque Limitation
A	0080	0000	Tctr	37 -	Controller Torque Control
A	0100	0000	Rstp	38 -	Ramp Stop
A	0200	0000	IxtLtim	39 -	Contr. Intel. Curr. Lim. LT-Ixt
A	0400	0000	IxtStlim	40 -	Contr. Intel. Curr. Lim. ST-Ixt
A	0800	0000	Tclim	41 -	Contr. Intel. Curr. Lim. Tc
A	1000	0000	MtempLim	42 -	Contr. Intel. Curr. Lim. Motor Temp.
A	2000	0000	Flim	43 -	Controller Freq. Limitation



Parameters *Warning* **269** and *Warning* **356** (Error Environment) display the warnings independent of the created warning mask.

Parameters *Controller Status* **275** and *Controller Status* **355** (Error Environment) display the controller status independent of the created warning mask.

16.4 Digital Inputs

The assignment of the control signals to the available software functions can be adapted to the application in question. Depending on the *Configuration* **30** selected, the default assignment or the selection of the operation mode differ. In addition to the available digital control inputs, further internal logic signals are available as sources.

The individual software functions are assigned to the various signal sources via parameterizable inputs. This enables a flexible use of the digital control signals.

Digital Inputs		Function
6 -	On	Signal input is switched on.
7 -	Off	Signal input is switched off.
13 -	Technology Controller Start	Start command technology controller (configuration 111 or 411).
61 -	Error Signal Output	Monitoring function signals an operational fault.
70 -	S1IND	Signal at digital input S1IND (X210A.3) (controller release linked permanently).
71 -	S2IND	Signal at digital input S2IND (X210A.4) or remote control via communication interface.
72 -	S3IND	Signal at digital input S3IND (X210A.5) or remote control via communication interface.
73 -	S4IND	Signal at digital input S4IND (X210A.6) or remote control via communication interface.
74 -	S5IND	Signal at digital input S5IND (X210A.7) or remote control via communication interface.
75 -	S6IND	Signal at digital input S6IND (X210B.1) or remote control via communication interface.
76 -	MFI1D	Signal at multifunction input MFI1 (X210B.6) in <i>Operation Mode</i> 452 = 3 - digital input or remote control via communication interface.
157 -	Warning Mask	The defined warnings mask of parameter <i>Create Warning Mask</i> 536 signals a critical operating point.

Table "Operation Modes for Digital Control Signals" continued on next page.

Digital Inputs	Function
158 - Timer 1	Output signal of the time function according to the input connection <i>Timer 1</i> 83 .
159 - Timer 2	Output signal of the time function according to the input connection <i>Timer 2</i> 84 .
163 - Reference Frequency reached	Signal when the <i>Actual Frequency</i> 241 has reached the reference frequency.
164 - Setting Frequency	Signal when the <i>Setting Frequency</i> 510 is smaller than or equal to the <i>Actual Frequency</i> 241 .
165 - Warning Ixt	The monitoring functions report an overload of the frequency inverter.
166 - Warning Heat sink temperature	Max. heat sink temperature T_K of 80 °C less the <i>Warning Limit Heat Sink Temp</i> 407 reached.
167 - Warning Inside temperature	Max. inside temperature T_i of 65 °C less the <i>Warning Limit Inside Temp.</i> 408 reached.
168 - Warning Motor Temperature	Warning behavior according to parameterized <i>Motor Temp. Operation mode</i> 570 at max. motor temperature T_{PTC} .
169 - General Warning	Signal when <i>Warnings</i> 269 are displayed with a critical operating point.
170 - Warning Over temperature	The selected limit values <i>Warning Limit Heat Sink Temp.</i> 407 , <i>Warning Limit Inside Temp</i> 408 or the maximum motor temperature have been exceeded.
171 - Output Comparator 1	The comparison according to the selected <i>OP. mode Comparator 1</i> 540 is true.
172 - Inverted Output Comparator 1	Operation mode 171 with inverted logic (LOW active).
173 - Output Comparator 2	The comparison according to the selected <i>OP. mode Comparator 2</i> 543 is true.
174 - Inverted Output Comparator 2	Operation mode 173 with inverted logic (LOW active).
175 - Digital Signal 1	Signal, according to parameterized <i>Operation Digital Output 1</i> 530 .
176 - Digital Signal 2	Signal according to parameterized <i>Digital Operation</i> 554 at multi-function output MFO1.
177 - Digital Signal 3	Signal, according to parameterized <i>Operation Mode Digital Output 3</i> 532 .
178 - Reference Percentage Reached	High when the <i>Actual Percentage Value</i> 230 has reached the <i>Reference Percentage Value</i> 229 .
179 - Mains Failure	Failure of the mains voltage and power regulation active according to <i>Operation Mode</i> 670 for the voltage controller.
180 - Warning Motor Protection Switch	Parameterized <i>Operation Mode</i> 571 of the motor protection switch has triggered.
220 - Logic module 1	Signal from output of logic module 1, according to parameterized <i>Operation Mode Logic 1</i> 198 .
221 - Logic module 1 inverted	Inverted signal from output of logic module 1.
222 - Logic module 2	Signal from output of logic module 2, according to parameterized <i>Operation Mode Logic 2</i> 201 .
223 - Logic module 2 inverted	Inverted signal from output of logic module 2.

Table "Operation Modes for Digital Control Signals" continued on next page.

Digital Inputs	Function
224 - Logic module 3	Signal from output of logic module 3, according to parameterized <i>Operation Mode Logic 3</i> 205 .
225 - Logic module 3 inverted	Inverted signal from output of logic module 3.
226 - Logic module 4	Signal from output of logic module 4, according to parameterized <i>Operation Mode Logic 4</i> 503 .
227 - Logic module 4 inverted	Inverted signal from output of logic module 4.
270 to 276	Operation modes 70 to 76 of the digital inputs inverted (LOW active).
282 - Arrived at desired Position	<i>Reference orientation</i> 469 of axle positioning reached.
320 - EM-S1IND ²⁾	Signal at digital input 1 of an EM extension module or remote control via communication interface
321 - EM-S2IND ²⁾	Signal at digital input 2 of an EM extension module or remote control via communication interface
322 - EM-S3IND ²⁾	Signal at digital input 3 of an EM extension module or remote control via communication interface
520 - EM-S1IND inverted	Operation mode 320 inverted.
521 - EM-S2IND inverted	Operation mode 321 inverted.
522 - EM-S3IND inverted	Operation mode 322 inverted.
525 - S1IND (Hardware) ¹⁾	Digital input S1IND (X210A.3).
526 - S2IND (Hardware) ¹⁾	Digital input S2IND (X210A.4).
527 - S3IND (Hardware) ¹⁾	Digital input S3IND (X210A.5).
528 - S4IND (Hardware) ¹⁾	Digital input S4IND (X210A.6).
529 - S5IND (Hardware) ¹⁾	Digital input S5IND (X210A.7).
530 - S6IND (Hardware) ¹⁾	Digital input S6IND (X210B.1).
531 - MFI1D (Hardware) ¹⁾	Multifunction input MFI1 (X210B.6) in <i>Operation Mode</i> 452 = 3 - digital input.
532 - EM-S1IND (Hardware) ¹⁾	Digital input 1 of an EM extension module.
533 - EM-S2IND (Hardware) ¹⁾	Digital input 2 of an EM extension module.
534 - EM-S3IND (Hardware) ¹⁾	Digital input 3 of an EM extension module.
537 to 545	Operation modes 525 to 533 of the digital inputs inverted (LOW active).
700 - RxPDO1 Boolean1 ³⁾	Signal if an optional expansion module EM with system bus is used.
701 - RxPDO1 Boolean2 ³⁾	Signal if an optional expansion module EM with system bus is used.
702 - RxPDO1 Boolean3 ³⁾	Signal if an optional expansion module EM with system bus is used.
703 - RxPDO1 Boolean4 ³⁾	Signal if an optional expansion module EM with system bus is used.
710 to 713 ³⁾	Operation modes 700 to 703 for RxPDO2 with an expansion module EM.
720 to 723 ³⁾	Operation modes 700 to 703 for RxPDO3 with an expansion module EM.
730 - Sysbus Emergency ³⁾	Signal if an optional expansion module EM with system bus is used.

1)The digital signal is independent of the setting of parameter Local/Remote **412**.

2)Refer to operating instructions of extension modules EM-IO

3)Refer to operating instructions "System bus EM-SYS extension module"

16.4.1 Start command

The parameters *Start Clockwise* **68** and *Start Anticlockwise* **69** can be linked to the available digital control inputs or the internal logic signals. The drive is only accelerated according to the control method after a start command.

The logic functions are used for the specification of the direction of rotation, but also for using the parameterized *Operation Mode 620* for the starting behavior and the *Operation Mode 630* for the stopping behavior.

16.4.2 3-Wire-Control

In the case of the 3-wire control, the drive is controlled by means of digital pulses. The drive is prepared for the start via the logic state of the signal Start 3-Wire Control **87** and started by a Start Clockwise (Parameter *Start Clockwise 68*) or a Start Anti-Clockwise (Parameter *Start Anti-Clockwise 69*) pulse. The drive is stopped by switching the signal Start 3-Wire Control **87** off.

The control signals for Start Clockwise and Start Anticlockwise are pulses. The functions Start Clockwise and Start Anticlockwise are latching signals if the signal Start 3-Wire Control **87** is switched on. The lock is released if the stop signal is switched off.

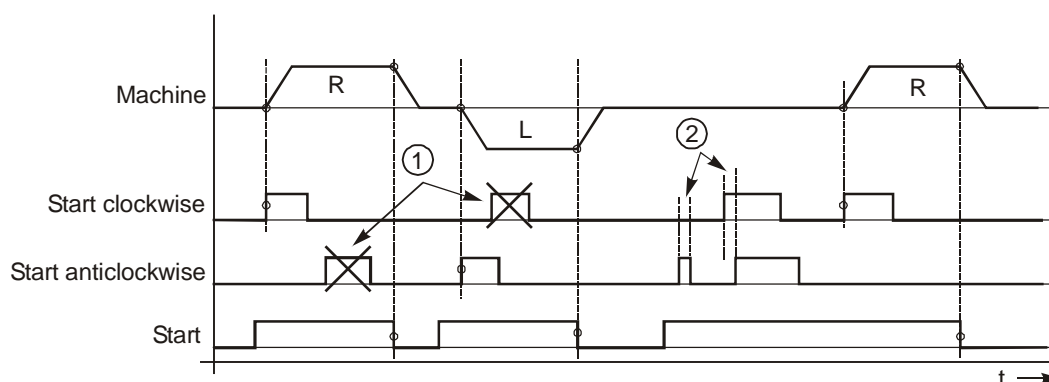

- (R)** Clockwise
- (L)** Anti-clockwise
- (1)** Signals are ignored
- (2)** Time $t < 32$ msec

The drive is started according to the configured starting behavior when the signal Start 3-Wire-Control **87** is switched on and a positive signal edge for Start Clockwise or Start Anti-Clockwise is detected.

Once the drive has been started, new edges **(1)** on the start signals are ignored.

If the start signal is shorter than 32 msec **(2)** or if both start signals were switched on within 32 msec **(2)**, the drive will be stopped according to the configured stopping behavior.

3-wire control is activated via parameter Local/Remote **412**:

Local/Remote 412	Function
5 - Ctrl. 3-Wire, direction Cont.	3-wire; control of direction of rotation and signal 3-Wire Control 87 via contacts.
46 - Ctrl. 3-Wire + KP, Dir. Cont. + KP	3-wire and control unit; control of direction of rotation and signal 3-Wire Control 87 via contacts or control unit.

For further operation modes of parameter Local/Remote **412**, refer to chapter 14.8 "Automatic Error Acknowledgment".

The frequency inverters feature various monitoring functions which can be adapted via the error and warning behavior. Switching the frequency inverter off at the various operating points should be avoided by an application-related parameterization. If there is a fault switch-off, this message can be acknowledged via the parameter *Program(ming) 34* or the logic signal connected with the parameter *Error Acknowledgment 103*.

16.4.3 Timer

The time functions can be selected via the parameters *Operation Mode Timer 1 790* and *Operation Mode Timer 2 793*. The sources of the logic signals are selected with the parameters *Timer 1 83* and *Timer 2 84* and processed according to the configured timer functions.

16.4.4 Thermo-contact

The monitoring of the motor temperature is a part of the error and warning behavior which can be configured as required. The parameter *Thermo contact* **204** links the digital input signal to the defined *Motor Temp. Operation Mode* **570** which is described in chapter 14.6 "Motor Temperature". The temperature monitoring via a digital input checks the input signal for the threshold value. Accordingly, a thermo contact or an additional circuit must be used if a temperature-dependent resistor is used.

16.4.5 n-/M-Control Change-Over

The field-orientated control procedures in configurations 230 and 430 contain the functions for speed or torque-dependent control of the drive. The change-over can be done during running operation of the drive, as an additional functionality monitors the transition between the two control procedures. The speed controller or the torque controller is active, depending on the *n-/M Control Change-Over* **164**.

16.4.6 Data Set Change-Over

Parameter values can be stored in four different data sets. This enables the use of various parameter values depending on the current operation point of the frequency inverter.

The change-over between the four data sets is done via the logic signals assigned to the parameters *Data Set Change-Over 1* **70** and *Data Set Change-Over 2* **71**.

The actual value parameter *Active Data Set* **249** shows the selected data set.

Activation		
<i>Data Set Change-Over 1</i> 70	<i>Data Set Change-Over 2</i> 71	Function/active data set
0	0	Data set 1 (DS1)
1	0	Data set 2 (DS2)
1	1	Data set 3 (DS3)
0	1	Data set 4 (DS4)

0 = contact open 1 = contact closed

If *Configuration* **30** = 110, 111, 410, 411 or 430 is selected, in the factory setting a timer function is interconnected between the digital input S4IND and the data set change-over 1.

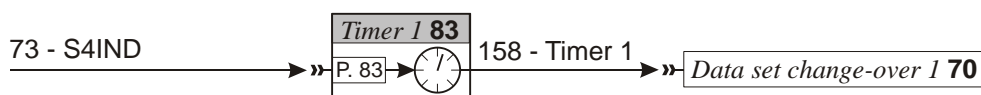

The data set change-over 1 is linked with timer 1.

Data set change-over 1 **70** = **158 – Timer 1**

Timer 1 is linked with the digital input S4IND (terminal X210A.6)

Timer 1 = **73 – S4IND**

In the factory setting the data set change-over 1 is not affected by the Timer 1:

Signal delay *Time 1 Timer 1* **791** = 0.00 s/m/h

Signal duration *Time 2 Timer 1* **792** = 0.00 s/m/h

16.4.7 Fixed Value Change-Over

Depending on the selected configuration, the reference values are specified via the assignment of the *Reference frequency source* **475** or *Reference percentage source* **476**. Accordingly, there can be a change between the fixed values by way of linking the logic signals to the parameters *Fixed frequency change-over 1* **66**, *Fixed frequency change-over 2* **67** or the parameters *Fixed percent change-over 1* **75**, *Fixed percent change-over 2* **76**.

By combining the logic states of the fixed frequency change-over modes 1 and 2, fixed frequencies 1 through 4 can be selected:

Fixed Frequency Control		
<i>Fixed Frequency Change-Over 1</i> 66	<i>Fixed Frequency Change-Over 2</i> 67	Function / active fixed value
0	0	Fixed Frequency 1 480
1	0	Fixed Frequency 2 481
1	1	Fixed Frequency 3 482
0	1	Fixed Frequency 4 483

0 = contact open 1 = contact closed

By combining the logic states of the fixed percentage change-over modes 1 and 2, fixed frequencies 1 through 4 can be selected:

Fixed Percentage Control		
<i>Fixed percentage value change-over 1</i> 75	<i>Fixed percentage value change-over 2</i> 76	Function / active fixed value
0	0	Fixed Percentage 1 520
1	0	Fixed Percentage 2 521
1	1	Fixed Percentage 3 522
0	1	Fixed Percentage 4 523

0 = contact open 1 = contact closed

16.4.8 Motor Potentiometer

The parameters *Reference Frequency Source* **475**, and *Reference Percentage Source* **476** contain operation modes with motor potentiometer. *Operation Mode* **474** defines the behavior of the motor potentiometer function and the parameters *Frequency Motorpoti Up* **62**, *Frequency Motorpot. Down* **63** or *Percent Motorpoti Up* **72**, *Percent Motorpot. Down* **73** the link to the available logic signals.

Motor Potentiometer Control		
Motorpoti Up	Motorpoti Down	Function
0	0	Output signal does not change.
1	0	Output value rises at set ramp.
0	1	Output value drops at set ramp.
1	1	Output value is reset to initial value.

0 = contact open 1 = contact closed

16.5 Function Modules

16.5.1 Timer

The timer function can be linked to various functions for time-control of digital signals.

The parameters *Operation Mode Timer 1* **790** and *Operation Mode Timer 2* **793** define the evaluation of the digital input signals and the unit of time of the time function.

Operation mode 790, 793	Function
0 - Off	Signal output is switched off.
1 - Normal, Rising Edge, Sec.	Positive signal edge starts timer (trigger), time 1 delays the output signal, time 2 defines the signal period.
2 - Retrigger, Rising Edge, Sec.	Positive signal edge starts timer (trigger), next positive signal edge within time 1 starts the delay in time again (Retrigger), time 2 defines the signal period.
3 - AND-Connect., Rising Edge, Sec.	Positive signal edge starts timer (trigger), if no input signal is received within time 1 the delay starts again (Retrigger), if no input signal is received within time 2, the signal period is terminated.
11 to 13	Operation modes 1...3, negative signal edge starts timer.
101 to 113	Operation modes 1...3, [in minutes].
201 to 213	Operation modes 1...3, [in hours].

By default, the functions are linked according to the following illustration:

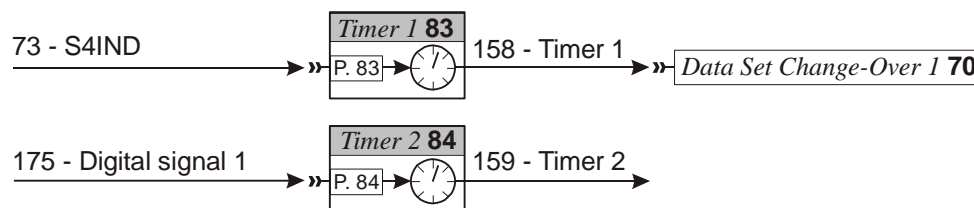

The sources of the digital signals (e.g. 73-S4IND, 175-Digital signal 1) are selected via the parameters *Timer 1* **83** and *Timer 2* **84**. Timer 1 is linked to digital input 4 and Timer 2 is linked to the logic signal digital signal 1.

The output signal of the timer can be assigned via the corresponding parameters of the operation mode of a digital input or output. By default, *Data Set Change-Over 1* is linked to Timer 1 and *Digital Output 1* **530** is linked to Timer 2.

NOTICE

Default settings: *Time 2 Timer 1* **792** = 0. Signals at digital input S4IND are forwarded to Data Set Change-Over 1 without delay.

16.5.1.1 Time Constant

The logic sequence of input and output signals is to be set separately for both timer functions via the time constants. The default parameter values result in a direct link of the input and output signal without a delay.



Before starting the timer, select the operation mode and set the time constants in order to avoid non-defined states.

Select operation mode for:	Set time constants in:
<i>Operation Mode Timer 1</i> 790	<i>Time 1 Timer 1</i> 791 (signal delay) <i>Time 2 Timer 1</i> 792 (signal duration)
<i>Operation Mode Timer 2</i> 793	<i>Time 1 Timer 2</i> 794 (signal delay) <i>Time 2 Timer 2</i> 795 (signal duration)

Parameter		Settings		
No.	Description	Min.	Max.	Default
791	Time 1 Timer 1, signal delay	0.00 s/m/h	650.00 s/m/h	0.00 s/m/h
792	Time 2 Timer 1, signal duration	0.00 s/m/h	650.00 s/m/h	0.00 s/m/h
794	Time 1 Timer 2, signal delay	0.00 s/m/h	650.00 s/m/h	0.00 s/m/h
795	Time 2 Timer 2, signal duration	0.00 s/m/h	650.00 s/m/h	0.00 s/m/h

Examples of the timer function depending on the selected operation mode and the input signal:

Normal, positive edge

Parameter *Operation Mode Timer 1* **790** or *Operation Mode Timer 2* **793** = 1

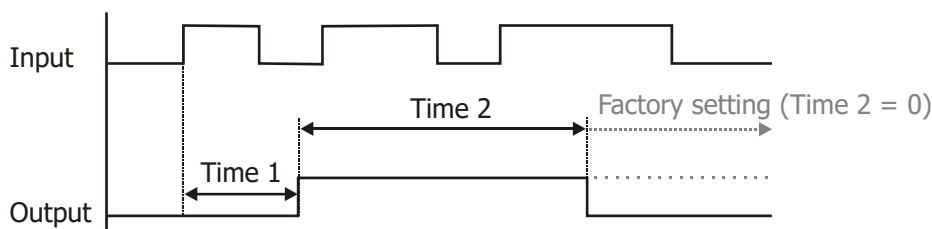

As soon as the positive signal edge is received at the input, time 1 starts. After the expiry of the signal delay, the output signal is activated for signal duration time 2.

In the factory settings of signal duration (*Time 2 Timer 1* **792** = 0 and *Time 2 Timer 2* **795** = 0) the timer does not reset the output signal.

Retrigger, positive edge

Parameter *Operation Mode Timer 1* **790** or *Operation Mode Timer 2* **793** = 2

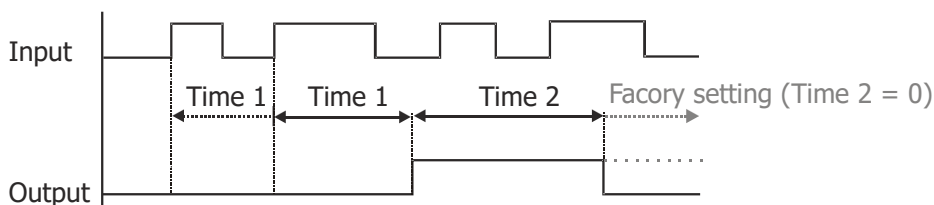

- ⏪: Time not run out completely
- ⏩: Time run out completely

As soon as the positive signal edge is received at the input, time 1 is started. If a positive signal edge is detected within the delay, time 1 starts again. After the expiry of the signal delay, the output signal is switched for the signal duration time 2.

In the factory settings of signal duration (*Time 2 Timer 1* **792** = 0 and *Time 2 Timer 2* **795** = 0) the timer does not reset the output signal.

AND connection, positive edge

Parameter *Operation Mode Timer 1* **790** or *Operation Mode Timer 2* **793 = 3**

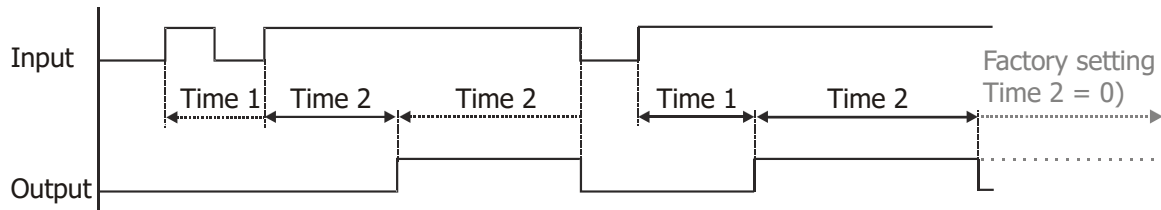

←-----: Time not run out completely
 ←-----: Time run out completely

As soon as the positive signal edge is received at the input, time 1 is started. If a positive signal edge is detected within time 1 (signal delay), time 1 starts again. After the expiry of the signal delay, the output signal is switched for the signal duration time 2. Within the signal duration time 2, the output is switched off by the input signal. If the input signal is present during the whole time 2, the output signal remains on in this time.

In the factory settings of signal duration (*Time 2 Timer 1* **792 = 0** and *Time 2 Timer 2* **795 = 0**) the timer does not reset the output signal.

16.5.2 Comparator

With the help of software functions Comparator 1 and 2, various comparisons of actual values with percentage-adjustable fixed values can be done.

The actual values to be compared can be selected from the following table with the parameters *Op. Mode Comparator 1* **540** and *Op. Mode Comparator 2* **543**.

If an expansion module is connected, further operation modes are available.

<i>Operation mode</i> 540, 543	Function
0 - Off	Comparator is switched off.
1 - Absolute current	<i>R.m.s Current</i> 211 > <i>Rated Current</i> 371 .
2 - Abs. Active Current	<i>Active Current</i> 214 > <i>Rated Current</i> 371 .
3 - Abs. Stator Frequency	<i>Stator Frequency</i> 210 > <i>Maximum Frequency</i> 419 .
4 - Abs. Actual Speed 1	<i>Encoder 1 Speed</i> 218 > maximum speed (calculated from <i>Maximum Frequency</i> 419 and <i>No. of Pole Pairs</i> 373).
5 - Abs. Actual Repetition Freq.	<i>Repetition Frequency Input</i> 252 > <i>Maximum Frequency</i> 419 .
6 - Winding Temp., Temp. Follow-Up.	<i>Winding Temperature</i> 226 > temperature 100 °C.
7 - Abs. Actual Frequency	<i>Actual Frequency</i> 241 > <i>Maximum Frequency</i> 419 .
9 - DC link voltage	<i>DC Link Voltage</i> 222 > Direct voltage 1000 V.
10 - Abs. Isq	<i>Isq</i> 216 > <i>Rated Current</i> 371 .
11 - Abs Filtered Active Current	<i>Active Current</i> 214 > <i>Rated Current</i> 371 .
12 - Abs. Internal Ref. Frequency	<i>Internal Reference Frequency</i> 228 > <i>Maximum Frequency</i> 419 .
13 - Abs. Ref. Percentage Value	<i>Reference Percentage Value</i> 229 > <i>Maximum Reference Percentage</i> 519 .
14 - Abs. Actual Percentage Value	<i>Actual Percentage Value</i> 230 > <i>Maximum Reference Percentage</i> 519 .
15 - Analog Input MFI1A Abs. Amount	<i>Analog Input MFI1A</i> 251 > input signal 100 %.
100 to 107	Operation modes with signs (+/-).

The switch-on and switch-off thresholds for comparactors 1 and 2 are set by the parameters *Comparator On above* **541, 544** and *Comparator Off below* **542, 545**.

The percentage limits of the corresponding reference values are indicated.

Parameter		Settings		
No.	Description	Min.	Max.	Default
541	Comparator 1 On above	- 300.00 %	300.00 %	100.00 %
542	Comparator 1 Off below	- 300.00 %	300.00 %	50.00 %
544	Comparator 2 On above	- 300.00 %	300.00 %	100.00 %
545	Comparator 2 Off below	- 300.00 %	300.00 %	50.00 %

The setting of the percentage limits of the comparators enables the following logical links. The comparison with signs is possible in the corresponding operation modes of the comparators.

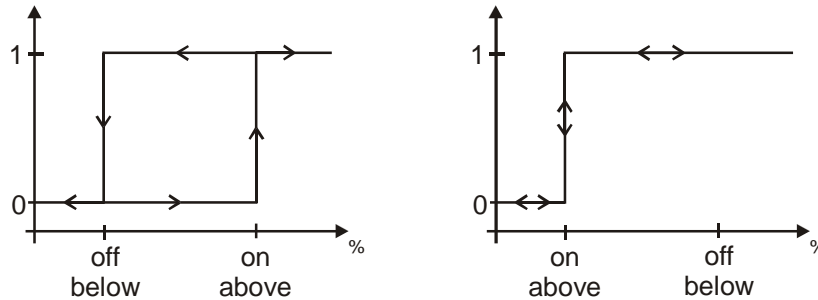

Example:

- Op. Mode Comparator 1* **540** = 7- Abs. Actual Frequency
- Comparator On above* **541** = 80.00 % (of Maximum Frequency **419**)
- Comparator Off below* **542** = 50.00 % (of Maximum Frequency **419**)
- Maximum Frequency* **419**. = 50.00 Hz
- Comparator will switch on if *Actual Frequency* **241** > 40.00 Hz
- Comparator will switch off if *Actual Frequency* **241** < 25.00 Hz

16.5.3 Logic Modules

With the Logic Modules function, it is possible to link external digital signals and internal logic signals of the frequency inverter to one another. Four identical logic modules are available. These modules can be parameterized independent of one another. The results of the logic operations can be used for further functions within and outside of the frequency inverter. In addition to the combinatory logic functions AND, OR and EXOR, the sequential logic functions RS flip-flop, D flip-flop and Toggle flip-flop are available.

Each module has two logic inputs and one logic output. The inputs can be parameterized and can be assigned to different signal sources. The signal sources are listed in the logic table in chapter 16.4 "Digital Inputs". Additionally, the logic modules can be interconnected to each other via the corresponding parameterization. The functionality of the parameters is the same in each of the four logic modules.



The logic modules are processed internally in the frequency inverter one after the other depending on their number. For example, logic module 1 is processed before logic module 2.

When designing application-specific logic links, e.g. in the case of time-critical applications:

- Make sure to comply with the correct order of the logic modules.
- Observe the processing time of 16 ms.

The following table shows the assignment of the parameters to the individual logic modules:

Module	Operation mode	Input 1	Input 2
Logic module 1	<i>Operation Mode Logic 1</i> 198	<i>Input 1 Logic 1</i> 199	<i>Input 2 Logic 1</i> 200
Logic module 2	<i>Operation Mode Logic 2</i> 201	<i>Input 1 Logic 2</i> 202	<i>Input 2 Logic 2</i> 203
Logic module 3	<i>Operation Mode Logic 3</i> 205	<i>Input 1 Logic 3</i> 206	<i>Input 2 Logic 3,</i> 207
Logic module 4	<i>Operation Mode Logic 4</i> 503	<i>Input 1 Logic 4</i> 504	<i>Input 2 Logic 4</i> 505

The parameters Operation Mode Logic 1 **198**, Operation Mode Logic 2 **201**, Operation Mode Logic 3 **205** and Operation Mode Logic 4 **503** include the following functions:

Operation mode	Function
0 - Off	Signal output is switched off.
1 - AND	Input 1 and input 2 are linked to each other via a logic AND operation.
2 - OR	Input 1 and input 2 are linked to each other via a logic OR operation.
3 - XOR	Input 1 and input 2 are linked to each other via a logic Exclusive OR operation. Output Q will be logic "1" only if different logic levels are present at input 1 and input 2.
10 - RS Flip-Flop	Input 1 is the set input, input 2 is the reset input of the RS flip-flop. Logic "1" at the set input will set output Q to "1". Logic "1" at the reset input will set output Q to "0". If logic "0" is present at both inputs, the output signal is kept at the last status.
20 - Toggle Flip-Flop	The output signal changes with the positive edge of the clock signal at input 1. Input 2 is wired internally in this configuration.
30 - D Flip-Flop	If a positive clock edge is received at input 2 (clock pulse input C), the signal present at input 1 (data input D) is transmitted to output Q.

Examples of the logic functions depending on the selected operation mode:

AND Operation

Parameter Operation Mode Logic = **1**

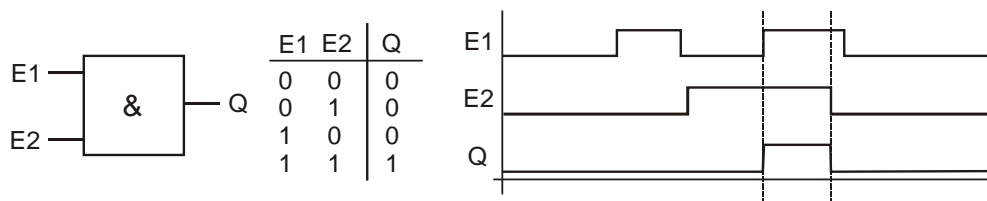

E1: input 1; E2: input 2; Q: output

If logic "1" is present at input 1 and input 2, output Q is logic "1". If both inputs or either one input are logic "0", output Q will be logic "0", too.

OR Operation

Parameter Operation Mode Logic = **2**

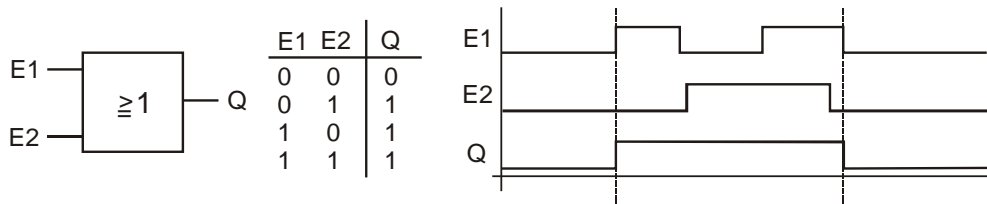

E1: input 1; E2: input 2; Q: output

If logic "1" is present at input 1 or input 2 or at both inputs, output Q is "1". If both inputs are "0", output Q will be logic "0", too.

EXOR Operation

Parameter Operation Mode Logic = **3**

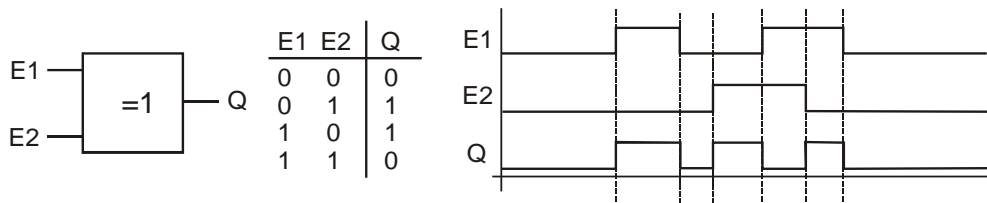

E1: input 1; E2: input 2; Q: output

Output Q is logic "1" if inputs 1 and 2 have different logic states. If both inputs have the same logic state, output Q will be logic "0".

RS Flip-Flop

Parameter Operation Mode Logic = **10**

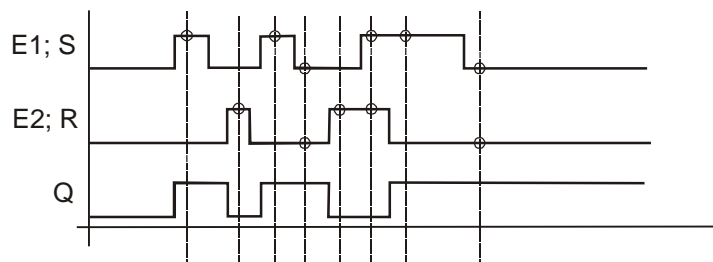
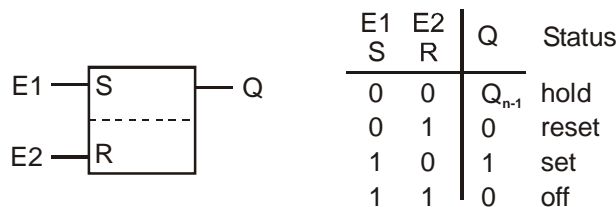

E1: set; E2: reset; Q: output

- Set: Logic "1" at the set input will set output Q to logic "1".
- Store: If a logic "0" is present at the S input, output Q remains unchanged.
- Reset: If the R input is set to logic "1", output Q is set to logic "0".
- Off: If both inputs are set to logic "1", output Q will be logic "0".

Toggle Flip-Flop

Parameter Operation Mode Logic = **20**

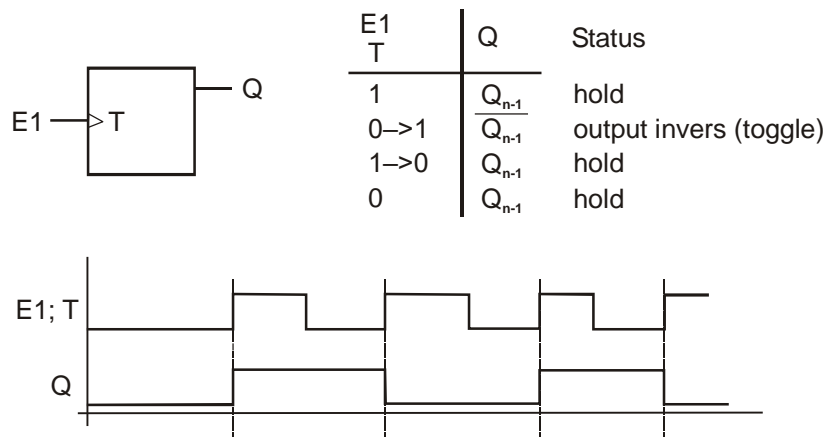

E1: clock input T; Q: output

The T flip-flop changes its output state with each positive clock edge at input 1 (clock pulse input T). In all other signal states of the clock input (static logic "0" or logic "1" or negative clock edge), the output signal remains unchanged.



Input 2 is deactivated in this configuration. A parameterization of input 2 via the corresponding parameters will have no effect for this reason.

D Flip-Flop

Parameter Operation Mode Logic = **30**

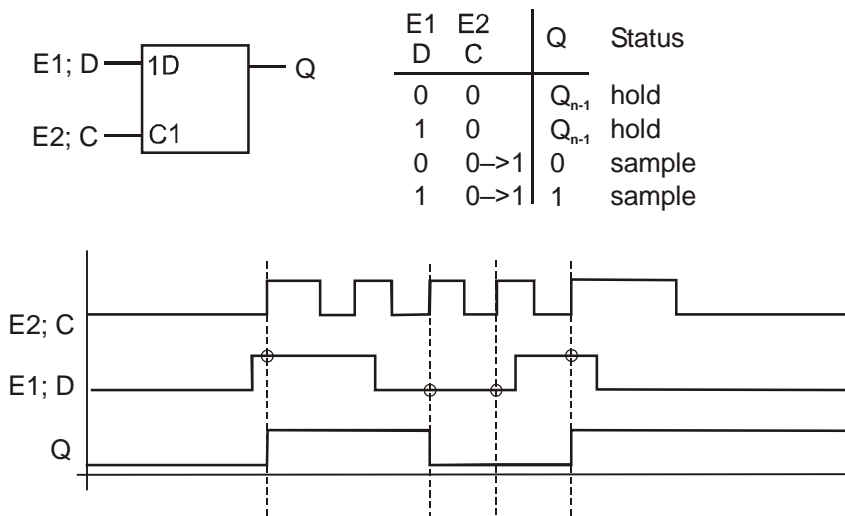

E1: data input D; E2: clock input C; Q: output

If logic "0" is present at input 2 (clock input C), the previous logic state is maintained at the output independent of the status of input 1 (data input D).

If a positive clock edge is received at clock pulse input C, the signal present at data input D is transmitted to the output. The output maintains its state Q_{n-1} until the next positive clock edge is received.

If a negative clock edge is received, the output signal remains unchanged.

17 V/f - Characteristic

The sensor-less control in configurations 110 and 111 is based on the proportional change of output voltage compared to the output frequency according to the configured characteristic.

By setting the V/f-characteristic, the voltage of the connected 3-phase motor is controlled according to the frequency. The torque to be applied by the motor at the corresponding operating point demands the control of the output voltage proportional to the frequency. At a constant output voltage / output frequency ratio of the frequency inverter, the magnetization is constant in the nominal operating range of the 3-phase motor. The rating point of the motor or end point of the V/f-characteristic is set via the guided commissioning with the parameter *Cut-Off Voltage* **603** and the parameter *Cut-Off Frequency* **604**.

The lower frequency range, where an increased voltage is necessary for the start of the drive, is critical. The voltage at output frequency = zero is set with the parameter *Starting Voltage* **600**. An increase in voltage deviating from the linear course of the V/f-characteristic can be defined by the parameters *Voltage Rise* **601** and *Rise Frequency* **602**. The percentage parameter figure is calculated from the linear V/f-characteristic. Via the parameters *Minimum Frequency* **418** and *Maximum Frequency* **419**, the working range of the machine or the V/f-characteristic is defined.

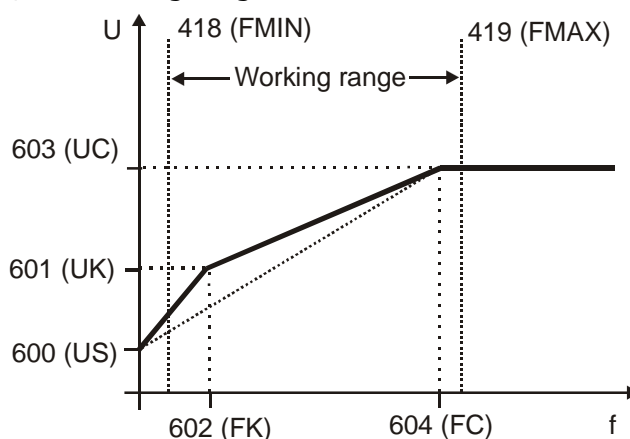

(FMIN): Minimum Frequency **418**, (FMAX): Maximum Frequency **419**,

(US): Starting Voltage **600**,

(UK): Voltage Rise **601**, (FK): Rise Frequency **602**,

(UC): Cut-Off Voltage **603**, (FC): Cut-Off Frequency **604**

Parameter		Settings		
No.	Description	Min.	Max.	Default
600	Starting Voltage	0.0 V	100.0 V	5.0 V
601	Voltage Rise	-100 %	200 %	10 %
602	Rise Frequency	0 %	100 %	20 %
603	Cut-Off Voltage	60.0 V	560.0 V	400.0 V
604	Cut-Off Frequency	0.00 Hz	599.00 Hz	50.00 Hz



The guided commissioning takes the parameterized rated motor values and reference data of the frequency inverter into account when it comes to pre-setting the V/f-characteristic. In the case of three-phase machines, the speed can be increased at a constant torque if the motor winding can be switched over from star to delta connection. If the data for delta connection indicated on the name plate of the three-phase motor were entered, the cut-off frequency is increased automatically by the square root of three.

The default *Cut-Off Voltage* **603 (UC)** and *Cut-Off Frequency* **604 (FC)** are derived from the motor data *Rated Voltage* **370** and *Rated Frequency* **375**. With the parameterized *Starting Voltage* **600 (US)**, the linear equation of the V/f-characteristic results.

$$U = \left(\frac{UC - US}{FC - 0} \right) \cdot f + US = \left(\frac{400.0 \text{ V} - 5.0 \text{ V}}{50.00 \text{ Hz} - 0.00 \text{ Hz}} \right) \cdot f + 5.0 \text{ V}$$

The *Rise Frequency* **602 (FK)** is entered as a percentage of the *Cut-Off Frequency* **604 (FC)**, the default value is $f=10 \text{ Hz}$. The output voltage for the default *Voltage Rise* **601 (UK)** is calculated as $U=92.4\text{V}$.

$$U = \left[\left(\frac{UC - US}{FC - 0} \right) \cdot (FK \cdot FC) + US \right] \cdot (1 + UK) = \left[\left(\frac{400 \text{ V} - 5 \text{ V}}{50 \text{ Hz} - 0 \text{ Hz}} \right) \cdot (0.2 \cdot 50 \text{ Hz}) + 5 \text{ V} \right] \cdot 1.1 = \underline{\underline{92.4 \text{ V}}}$$

Dynamic Voltage Pre-Control

The *Dyn. Voltage Pre-Control* **605** accelerates the control behavior of the current limit controller (parameter *Operation Mode* **610**) and the voltage controller (parameter *Operation Mode* **670**). The output voltage value resulting from the V/f characteristic is changed by addition of the calculated voltage pre-control.

Parameter		Settings		
No.	Description	Min.	Max.	Default
605	Dyn. Voltage Pre-Control	0 %	200 %	100 %

18 Control Functions

The frequency inverters provide a selection of established control methods in *Configuration 30*. The selected control structure can be parameterized as required and optimized for the application by further functions.

18.1 Intelligent current limits

The current limits to be set according to the application avoid inadmissible loading of the connected load and prevent a fault switch-off of the frequency inverter. The function extends the current controller available in the control system. The overload reserve of the frequency inverter can be used optimally by means of the intelligent current limits, in particular in applications with dynamic load alternations. The criterion to be selected via the parameter *Operation Mode 573* defines the threshold to the activation of the intelligent current limit. The parameterized rated motor current or the reference current of the frequency inverter is synchronized as the limit value of the intelligent current limits.

Operation mode	Function
0 - Off	The function is switched off.
1 - Ixt	Limitation to the overload of the frequency inverter (Ixt).
10 - Tc	Limitation to the maximum heat sink temperature (Tc).
11 - Ixt + Tc	Operation mode 1 and 10 (Ixt + Tc).
20 - Motor Temp.	Limitation to the motor temperature (T _{Motor}).
21 - Motor Temp.+ Ixt	Operation mode 20 and 1 (T _{Motor} + Ixt).
30 - Tc + Motor Temp.	Operation mode 10 and 20 (Tc + T _{Motor}).
31 - Tc + Motor Temp. + Ixt	Operation mode 10, 20 and (Tc + T _{Motor} + Ixt).

The threshold value selected via the parameter *Operation Mode 573* is monitored by the intelligent current limits. In the operation modes with motor and heat sink temperature monitoring, the reduction of power selected with the parameter *Power Limit 574* is done when the threshold value has been reached. This is achieved by a reduction of the output current and the speed in motor operation. The load behavior of the connected machine must be a function of the speed to ensure a sensible use of the intelligent current limits. The total time of the power reduction as a result of an increased motor or heat sink temperature contains not only the cooling time, but also the additionally defined *Limitation Time 575*.

The definition of the power limit should be selected as small as possible in order to give the drive sufficient time to cool down. The reference value is the nominal power of the frequency inverter or the set rated power of the motor.

Parameter		Settings		
No.	Description	Min.	Max.	Default
574	Power Limit	40.00 %	95.00 %	80.00 %
575	Limitation Time	5 min	300 min	15 min

In the operation modes with overload reserve (Ixt) there is a reduction of the output current when the threshold value is exceeded, with a distinction being made between long and short-term overload reserve. After the short-term overload (1 s) has been used up, the output current is reduced to the long-term overload current matching the present switching frequency. After the long-term overload current has been used up (60 s), the output current is reduced to the rated current which also depends on the switching frequency. If the output current has already been reduced due to the fact that the long-term overload has used up, the short-term overload is no longer available even if it has not been used up beforehand. The defined overload reserve (Ixt) of the frequency inverter is available again after a power reduction lasting 10 minutes.

18.2 Voltage controller

The voltage controller contains the functions necessary for monitoring the DC link voltage.

- The DC link voltage which rises in generator operation or in the braking process of the 3-phase machine is controlled to the set limit value by the voltage controller.
- The mains failure regulation uses the rotation energy of the drive to bridge short-term power failures.

The voltage controller is set with the parameter *Operation Mode* **670** in accordance with the application.

Operation mode	Function
0 - Off	The function is switched off.
1 - Udc-Limitation active	Overvoltage controller switched on, with motor chopper.
2 - Mains Support active	Mains failure regulation switched on, with motor chopper, for quick shutdown.
3 - Udc-Limit. & Mains Supp. active	Overvoltage controller and mains failure regulation switched on, with motor chopper.
12 - Mains Support active, Chopper not active	Mains failure regulation switched on, without motor chopper.
13 - Udc-Limit. & Mains Supp. active, without Chopper	Overvoltage controller and mains failure regulation switched on, without motor chopper.

The function motor chopper is available in the field-oriented control methods (in configurations 210, 230, 410, 411 and 430).

When an operation mode with motor chopper is selected, set the *Trigger Threshold* **507** to the *Reference DC-Link Limitation* **680**.

Operation mode Overvoltage control,

Voltage controller: Parameter *Operation Mode* **670** = 1

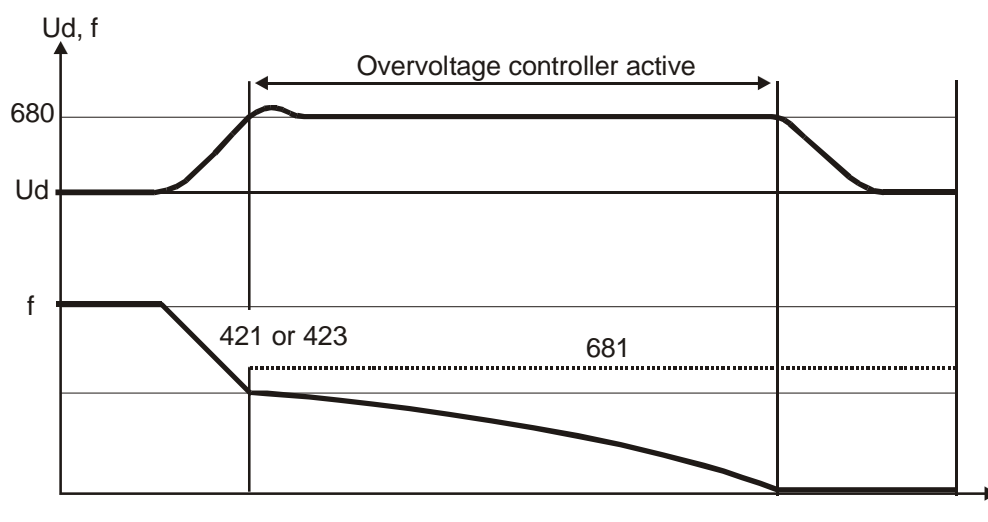

The overvoltage controller prevents a switch-off of the frequency inverter in generator operation. The reduction of the drive speed by a ramp gradient selected via the parameter *Deceleration Clockwise* **421** or *Deceleration Anticlockwise* **423** can lead to an overvoltage in the DC link.

If the voltage exceeds the value set by the parameter *Reference DC-Link Limitation* **680**, the deceleration is reduced in such a way that the DC link voltage is regulated to the set value. If the DC link voltage cannot be regulated to the set reference value by the reduction of the deceleration, the deceleration is stopped and the output frequency raised. The output frequency is calculated by addition of the parameter value *Max. Frequency Rise* **681** to the frequency at the operating point of the controller intervention.

Parameter		Settings			
No.	Description	ACT	Min.	Max.	Default
680	Reference DC-Link Limitation	210	225	387.5	380 V
		410	425	775	760 V
681	Max. Frequency Rise	210/410	0.00 Hz	599.00 Hz	10.00 Hz

Operation mode mains failure regulation.

Voltage controller: Parameter *Operation Mode* **670** = 2

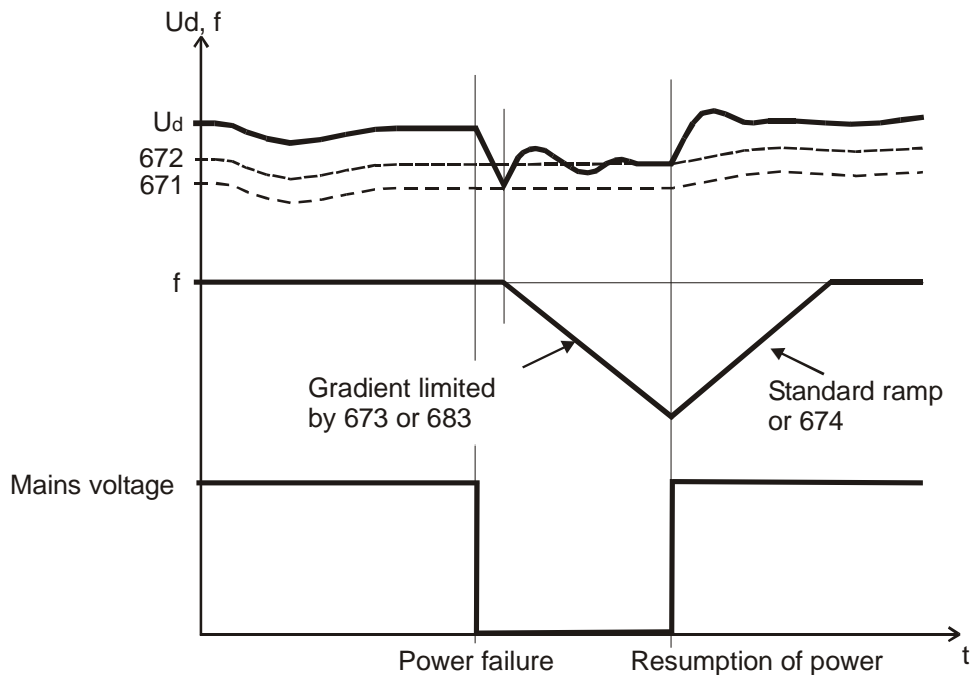

The DC link voltage which is available in the case of a power failure is supplied by the motor. The output frequency is continuously reduced and the motor with its rotating masses is switched over to generator operation. The maximum reduction of the output frequency is done at the current set by the parameter *Gen. ref. current limit* **683** or the ramp *Mains support deceleration* **673** until the frequency limit *Shutdown threshold* **675** is reached. If the energy of the system for bridging the mains failure is not sufficient, the delay is affected at maximum ramp gradient as from the *Shutdown threshold* **675**.

The time required until the motor has come to a standstill results from the regenerative energy of the system which results in an increase in the DC link voltage. The DC link voltage set with the parameter *Reference shutdown value* **676** is used by the voltage controller as a control figure and kept constant. The voltage rise enables optimization of the braking behavior and the time until the drive has come to a standstill. The behavior of the controller can be compared to stopping behavior 2 (Shutdown + Stop), as the voltage controller brings the drive to a standstill at the maximum deceleration ramp and supplies it with the remaining DC link voltage.

If the DC-link voltage is restored before the shutdown of the drive, but after falling below *Shutdown Threshold* **675**, the drive is still decelerated to standstill.

If the mains voltage is restored after the shutdown of the drive but before the undervoltage switch-off has been reached, the frequency inverter signals a fault. The control unit displays the fault message "F0702".

If the mains failure without shutdown (*Shutdown threshold* **675** = 0 Hz) takes so long that the frequency has been reduced to 0 Hz, the drive is accelerated to the reference frequency when the mains supply is restored.

If the mains failure with or without shutdown takes so long that the frequency inverter shuts off completely (LED's = OFF), the frequency inverter will be in the "Standby" state when the

mains supply is restored. If the inverter is released again, the drive will start. If the drive is to start automatically after restoration of the mains supply if the inverter is released permanently, *Operation mode 651* of Auto Start must be switched on.

Parameter		Settings		
No.	Description	Min.	Max.	Default
671	Mains Failure Threshold	-200.0 V	-50.0 V	-100.0 V
672	Reference Mains Support Value	-200.0 V	-10.0 V	-40.0 V



The frequency inverter reacts to the signals at the control inputs both when the power failure regulation is switched on and in normal operation. A control via externally supplied control signals is only possible in the case of a no-break supply. As an alternative, supply of the control signals through the frequency inverter is to be used.

Operation mode mains failure regulation (continued)

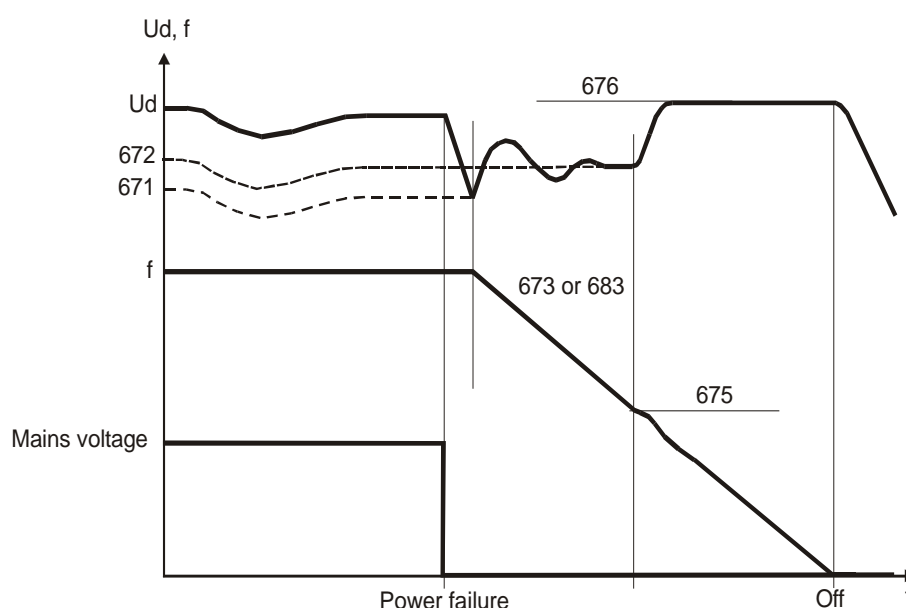

The DC link voltage which is available in the case of a power failure is supplied by the motor. The output frequency is continuously reduced and the motor with its rotating masses is switched over to generator operation. The maximum reduction of the output frequency is done at the current set by the parameter *Gen. Ref. Current Limit 683* or the ramp *Mains Support Deceleration 673* until the frequency limit *Shutdown Threshold 675* is reached. If the energy of the system for bridging the mains failure is not sufficient, the delay occurs at maximum ramp gradient as from the *Shutdown Threshold 675*.

The time required until the motor has come to a standstill results from the regenerative energy of the system which results in an increase in the DC link voltage. The DC link voltage set with the parameter *Reference Shutdown Value 676* is used by the voltage controller as a control figure and kept constant. The voltage rise enables optimization of the braking behavior and the time until the drive has come to a standstill. The behavior of the controller can be compared to stopping behavior 2 (Shutdown + Stop), as the voltage controller brings the drive to a standstill at the maximum deceleration ramp and supplies it with the remaining DC link voltage.

If the mains voltage is restored after the shutdown of the drive but before the undervoltage switch-off has been reached, the frequency inverter signals a fault. The control unit displays the fault message "F0702".

If the mains failure without shutdown (*Shutdown Threshold* **675** = 0 Hz) takes so long that the frequency has been reduced to 0 Hz, the drive is accelerated to the reference frequency when the mains supply is restored.

If the mains failure with or without shutdown takes so long that the frequency inverter shuts off completely (LEDs = OFF), the frequency inverter will be in the "Standby" state when the mains supply is restored. If the inverter is released again, the drive will start. If the drive is to start automatically after restoration of the mains supply and if the inverter is released permanently, *Operation Mode* **651** of Auto Start must be switched on.

Parameter		Settings			
No.	Description	ACT	Min.	Max.	Default
675	Shutdown Threshold		0.00 Hz	599.00 Hz	0.00 Hz
676	Reference Shutdown Value	210	225	387.5	365
		410	425		



The *Shutdown Threshold* **676** becomes effective below the frequency value *Shutdown Threshold* **675**.

The voltage controller uses the limit values of the DC link voltage. The frequency change necessary for this is parameterized by the generator reference current value or rather the ramp. The *Gen. Ref. Current Limit* **683** or the ramp *Mains Support Deceleration* **673** defines the maximum deceleration of the drive necessary in order to reach the voltage value *Reference Mains Support Value* **672**. The *Acceleration on Mains Resumption* **674** replaces the set values of the ramp parameters *Acceleration (Clockwise)* **420** or *Acceleration Anticlockwise* **422** if the value set in the factory is changed. The voltage control in a mains failure changes from the frequency limit *Shutdown Threshold* **675** from *Reference Mains Support Value* **672** to the *Reference Shutdown Value* **676**.

Parameter		Settings		
No.	Description	Min.	Max.	Default
683	Gen. Ref. Current Limit	0.0 A	0 · I _{FIN}	I _{FIN}
673	Mains Support Deceleration	0.01 Hz/s	9999.99 Hz/s	50.00 Hz/s
674	Acceleration on Mains Resumption	0.00 Hz/s	9999.99 Hz/s	0.00 Hz/s

The proportional and integrating part of the current controller can be set via parameters *Amplification* **677** and *Integral Time* **678**. The control functions are deactivated by setting the parameters to 0. The controllers are P and I controllers in the corresponding settings.

Parameter		Settings		
No.	Description	Min.	Max.	Default
677	Amplification	0.00	30.00	- 1)
678	Integral Time	0 ms	10000 ms	- 1)

¹⁾ The factory settings are depending on the selected control function. Corresponding with the setting of the parameter *Configuration* **30** the following values are assigned:

Configuration 1xx: *Amplification* **677** = 1.0 / *Integral Time* **678** = 8 ms

Configuration 2xx; 4xx: *Amplification* **677** = 2.0 / *Integral Time* **678** = 23 ms

18.3 Technology Controller

The technology controller, the behavior of which corresponds to a PI controller, is available as an additional function in configuration 111, 211 and 411. The connection of reference and actual value of the application with the functions of the frequency inverter enables process control without further components. In this way, applications such as pressure, volume flow or speed control can be implemented easily.

The configuration of the reference percentage source and the assignment of the actual percentage source are to be considered.

Structural image: Technology Controller

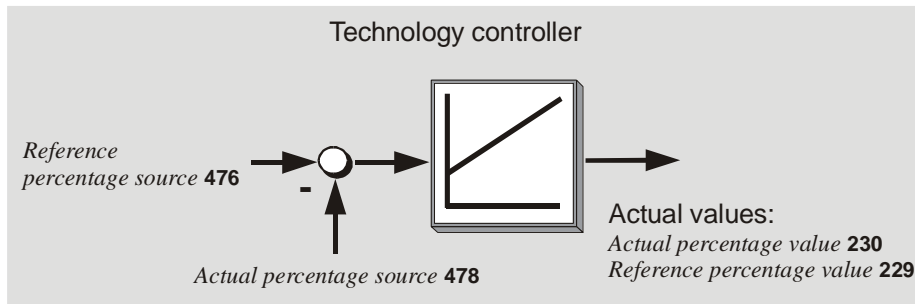

For the reference value, the technology controller also demands the assignment of an analog application value with the parameter *Actual Percentage Source* **478**. The difference between reference and actual value is used by the technology controller to control the drive system. The measured actual value is mapped via a signal converter onto the input signal of the reference percentage source.

<i>Operation mode 478</i>		Function
1 -	Analog Input MFI1A	The analog signal on the multifunctional input 1 in <i>Operation Mode 452</i> - analog operation.
32 -	Rep. Frequency Input (F3)	The frequency signal at the digital input according to the selected <i>Operation Mode 496</i> .



The default assignment of parameter *Start clockwise* **68** to the logic signal of the technology controller must be observed:

Start Clockwise **68** = 13 - Technology Controller Start.

This assignment may not be changed. The technology controller becomes active with the controller release at digital input S1IND.

Structural image: Inputs for Actual Percentage Source

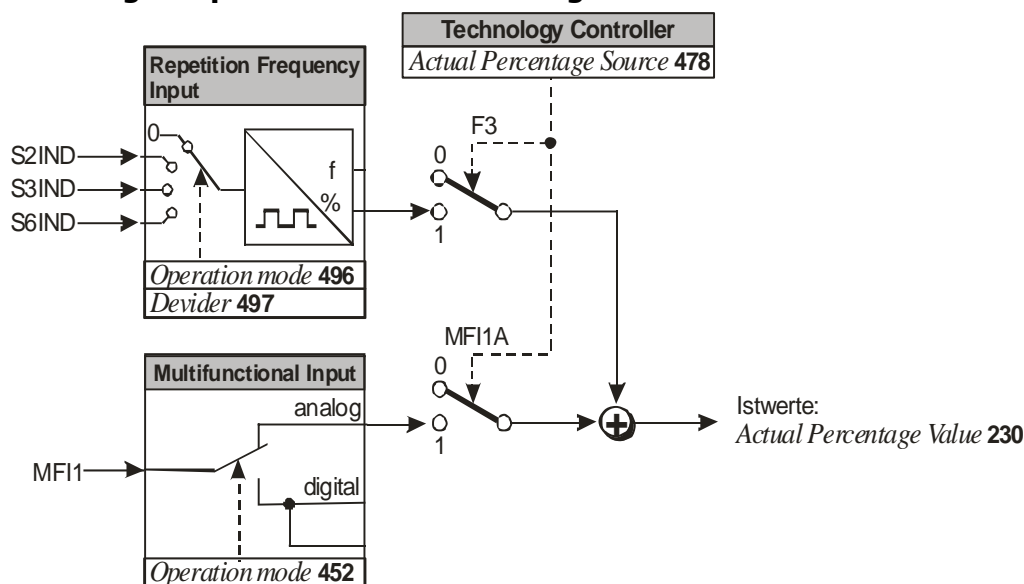

The function selected via the parameter *Operation Mode* **440** defines the behavior of the technology controller.

<i>Operation mode</i> 440	Function
0 - Off	The technology controller is switched off, the reference value specification is done via the reference percentage channel.
1 - Standard	For pressure and volume flow control with linear operating behavior and actual value monitoring.
2 - Liquid Level 1	Contents level control at defined motor speed with actual value missing.
3 - Liquid Level 2	Contents level control at defined motor speed with actual value missing or high control deviation.
4 - Speed controller	Speed control with analog feedback of the actual speed.
5 - Indirect volume flow control	Volume flow control with square rooted actual value.

The behavior of the technology controller corresponds to a PI controller with the components

- proportional component *Amplification* **444**
- integral component *Integral time* **445**

The sign of the amplification determines the direction of control, i.e. with a rising actual value and pos. sign of the amplification, the output frequency is reduced (e.g. in pressure control). With a rising actual value and neg. sign of the amplification, the output frequency is increased (e.g. in temperature control systems, refrigerating machines, condensers).

The integral component can be used to reduce the steady-state control deviation (deviation between actual value and reference value) over a period of time. If the integral component is too dynamic (Dynamic behavior: fast correction of deviations) the system will be unstable and oscillates. If the integral component is too passive (Passive behavior: slow correction of deviations) the steady-state control deviation will not be corrected adequately.

Therefore, the integral component must be adjusted installation-dependent.

Parameter *Max. P-Component* **442** limits the frequency change at the controller output. This prevents oscillations of the system at steep acceleration ramps.

Via Parameter *Hysteresis* **443** changes of the integral component in a specified range (hysteresis band) can be rejected. This causes more passive behavior of the technology controller and helps to filter noise signals of the controller actual value and to minimize control corrections.

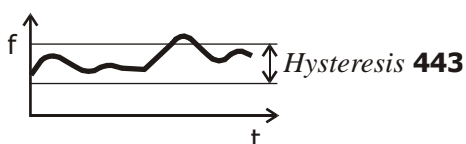

Parameter		Settings		
No.	Description	Min.	Max.	Default
441	Fixed Frequency	-599.00 Hz	+599.00 Hz	0.00 Hz
442	max. P-Component	0.01 Hz	599.00 Hz	50.00 Hz
443	Hysteresis	0.01 %	100.00 %	10.00 %
444	Amplification	-15.00	+15.00	1.00
445	Integral Time	0 ms	32767 ms	200 ms
446	Ind. Volume Flow Control Factor	0.10	2.00	1.00



The parameterization of the technology controller in the individual data sets enables an adaptation to various operating points of the application with the data set change-over via control contacts.

Operation mode standard, parameter Operation Mode 440 = 1

This operation mode can be used, for example, for pressure or volumetric flow control with linear operation behavior.

The minimum value monitoring prevents an acceleration of the drive if the actual value is missing.

If the actual value is missing (< 0.5%) the output frequency is guided to the *Minimum frequency* **418**. This is done using the set *Deceleration (clockwise)* **421**.

If the actual value is available again, the controller continues operation automatically.

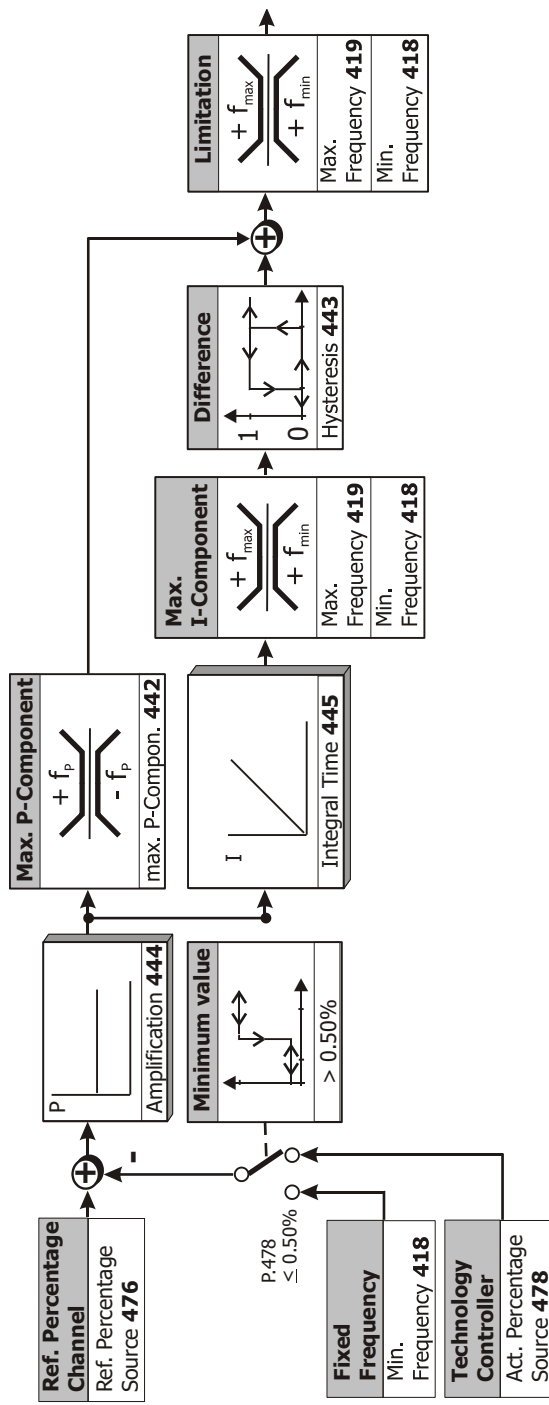

Operation mode filling level 1, parameter Operation Mode 440 = 2

This operation mode can be used, for example, for contents level control. If the actual value is missing, the function brings the output frequency to an adjustable value.

The minimum value monitoring prevents an acceleration of the drive if the actual value is missing. If the actual value is missing (< 0.5%) the output frequency is guided to the *Fixed frequency* **441**. This is done using the set *Deceleration (clockwise)* **421**.

The *Fixed frequency* **441** must be in the range between *Minimum frequency* **418** and *Maximum frequency* **419**. If the *Fixed frequency* **441** is set to a value smaller than the *Minimum frequency* **418**, the output frequency is guided to *Minimum frequency* **418**. The frequency will not drop below *Minimum frequency* **418**.

If the actual value is available again, the controller continues operation automatically.

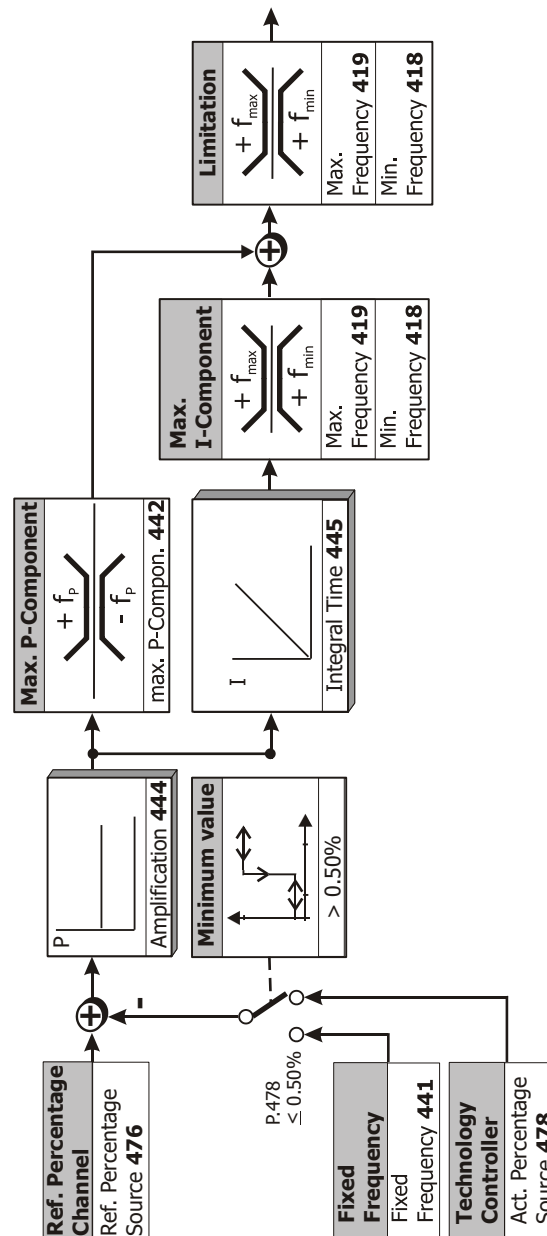

Operation mode filling level 2, parameter Operation Mode 440 = 3

This operation mode can be used, for example, for contents level control.

The minimum value monitoring prevents an acceleration of the drive if the actual value is missing.

If the actual value is missing ($< 0.5\%$) the output frequency is guided to the *Fixed frequency 441*. This is done using the set *Deceleration (clockwise) 421*.

If there is no control deviation (actual value = reference value) or if the control deviation is negative (actual value $>$ reference value), the output frequency is guided to *Minimum frequency 418*. This is done using the set *Deceleration (clockwise) 421*.

The drive accelerates as soon as an actual value is present again or the control deviation exceeds the positive *Hysteresis 443*. The drive stops as soon as the control deviation falls below the negative *Hysteresis 443*.

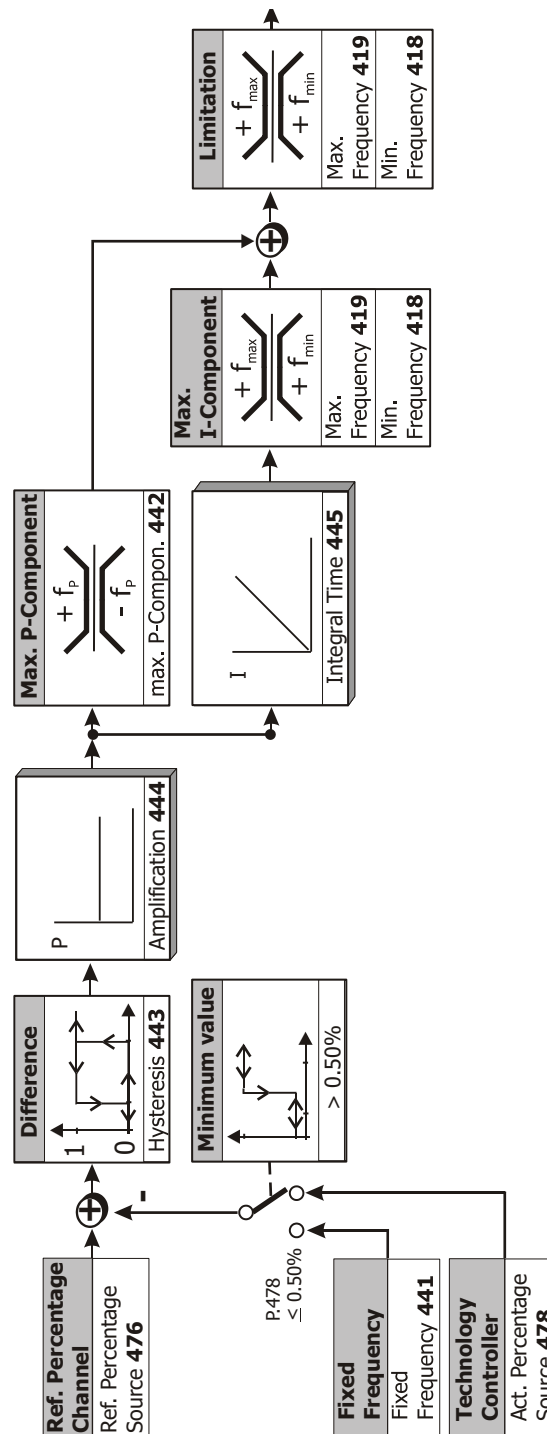

NOTICE

Excessive motor heat-up

When *Operation Mode 440* is set to "4-Speed Controller", *Minimum Frequency 418* has no limiting effect. In Configurations 411 and 611 this can result in longer operation of the motor in current impression mode (current frequency < *Frequency Limit 624*) and therefore in excessive motor heat-up.

- Prevent excessive motor heat-up by long current impression operation.

Operation Mode "4-Speed Controller" can result in reversal of the drive.

Operation mode speed controller, parameter Operation Mode 440 = 4

This operation mode is suited for speed controls with an analog actual value transmitter (e.g. analog speedometer via analog input or HTL encoder via frequency input).

The motor is accelerated or decelerated according to the control deviation.

The output frequency is limited by the *Maximum frequency* **419**.

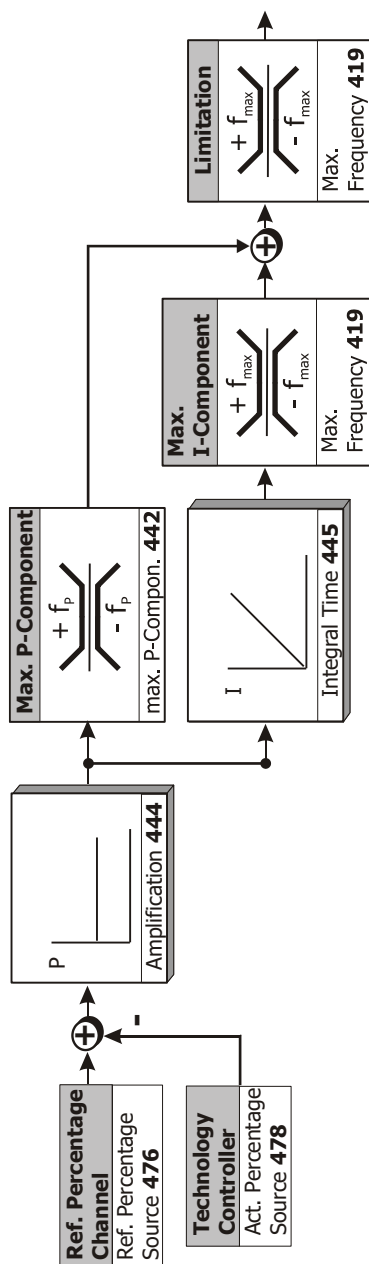

Operation mode indirect volume flow control,
parameter Operation Mode 440 = 5

This operation mode is suitable for volume flow control based on pressure measurement.

The square rooted actual value enables, for example, direct measurement of the active pressure in the system via the intake nozzle of the fan. The active pressure has a square proportion to the volume flow and thus forms the control figure for the volume flow control. The calculation corresponds to the "Law of Proportionality" which is generally valid for centrifugal machines.

Adaptation to the application in question and measurement are done via the *Ind. volume flow control factor* **446**. The actual values are calculated from the system data to be parameterized, reference pressure and volume flow, according to the bad point method, as described in chapter 20.4.2 "Volume Flow and Pressure".

The output frequency is limited by the *Minimum frequency* **418** and *Maximum frequency* **419**.

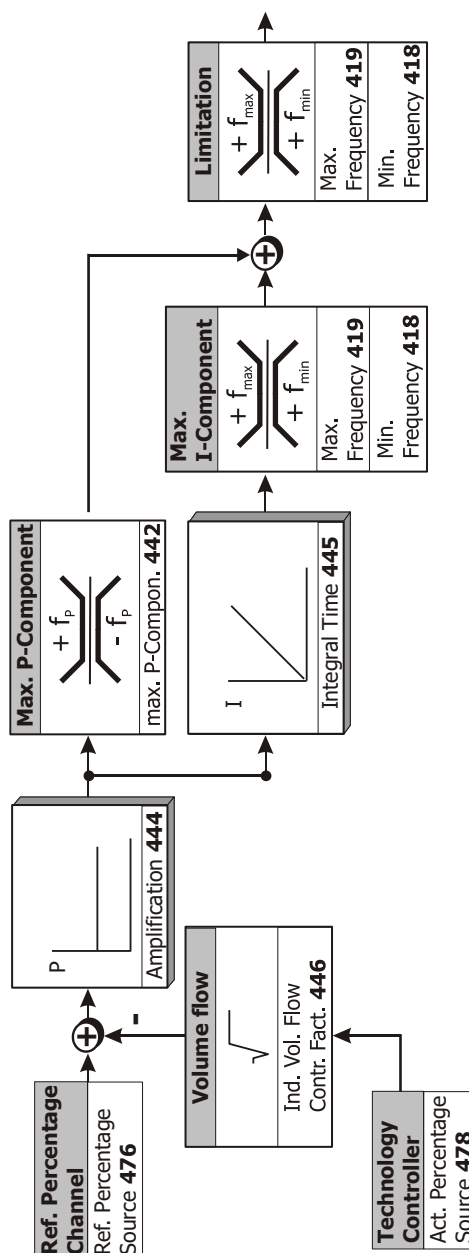

Structural image: Indirect volume flow control

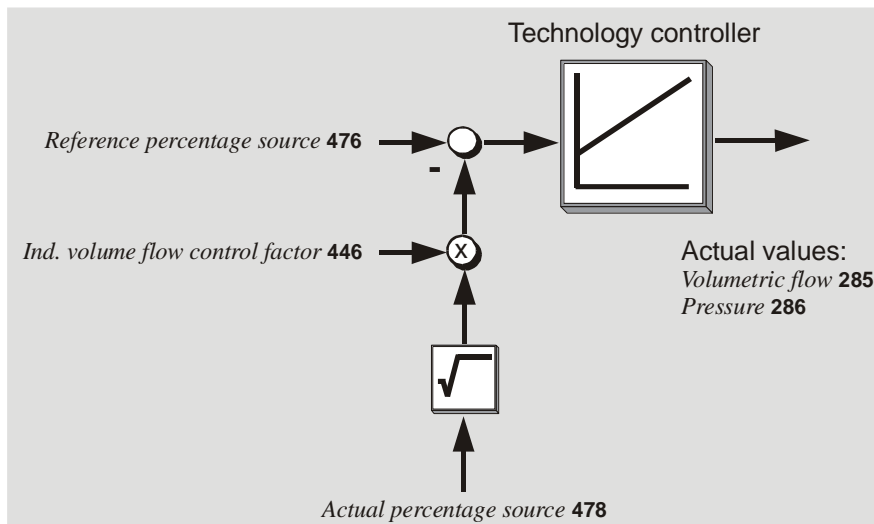

18.4 Functions of Sensorless Control

The configurations of the sensor-less control contain the following additional functions, which supplement the behavior according to the parameterized V/f characteristic.

18.4.1 Slip compensation

The load-dependent difference between the reference speed and the actual speed of the 3-phase motor is referred to as the slip. This dependency can be compensated by the current measurement in the output phases of the frequency inverter.

The activation of *Operation Mode 660* for the slip compensation enables speed control without feedback. The stator frequency and speed are corrected depending on the load.

The slip compensation is activated during the guided commissioning. The *Stator Resistance 377* is required to ensure a correct function and is measured during the guided commissioning.

If no guided commissioning is executed, the slip compensation can be activated manually. In these cases, enter the value for the *Stator Resistance 377* manually according to the motor data sheet.

<i>Operation mode 660</i>	Function
0 - Off	The slip compensation is deactivated.
1 - Switched on	The load-dependent slip speed is compensated.

The control behavior of the slip compensation can only be optimized via the parameters in the case of specific applications. The parameter *Amplification 661* determines the correction of the speed and the effect of the slip compensation proportionally to the change of load. The *Max. Slip Ramp 662* defines the max. frequency change per second in order to avoid an overload in the case of a load change.

The parameter *Minimum Frequency 663* determines the frequency as from which the slip compensation becomes active.

Parameter		Settings		
No.	Description	Min.	Max.	Default
661	Amplification	0.0 %	300.0 %	100.0 %
662	Max. Slip Ramp	0.01 Hz/s	650.00 Hz/s	5.00 Hz/s
663	Minimum Frequency	0.01 Hz	599.00 Hz	0.01 Hz

18.4.2 Current limit value controller

Via a load-dependent speed control, the current limit controller ensures that the drive system is not overloaded. This is extended by the intelligent current limits described in the previous chapter. The current limit value controller reduces the load on the drive, e.g. during acceleration, by stopping the acceleration ramp. The switch-off of the frequency inverter which happens when the acceleration ramps have been set at an excessive gradient is prevented in this way.

The current limit value controller is switched on and off via parameter *Operation Mode* **610**.

<i>Operation Mode</i> 610		Function
0 -	Off	The current limit controller functions and the intelligent current limits have been deactivated.
1 -	Switched on	The current limit controller is active.

Behavior in motor operation:

If the current set via parameter *Current Limit* **613** is exceeded, the activated current limit controller will reduce the output frequency until the current limit is no longer exceeded. The output frequency is reduced, as a maximum, to the frequency set by parameter *Frequency Limit* **614**. If the current is below the *Current Limit* **613**, the output frequency increases to the reference value again.

Behavior in generator operation:

If the current set via parameter *Current Limit* **613** is exceeded, the activated current limit controller will increase the output frequency until the current limit is no longer exceeded. The output frequency is increased, as a maximum, to the set *Maximum Frequency* **419**. If the current is below the *Current Limit* **613**, the output frequency is reduced to the required reference value again.

Parameter		Settings		
No.	Description	Min.	Max.	Default
613	Current Limit	0.0 A	0 · I _{FIN}	0 · I _{FIN}
614	Frequency Limit	0.00 Hz	599.00 Hz	0.00 Hz

The control behavior of the current limit controller can be set via the proportional component, parameter *Amplification* **611**, and the integrating component, parameter *Integral Time* **612**. If an optimization of the controller parameters is necessary in exceptional cases, a setting should be done by changing parameter *Current Limit* **613** abruptly.

Parameter		Settings		
No.	Description	Min.	Max.	Default
611	Amplification	0.01	30.00	1.00
612	Integral Time	1 ms	10000 ms	24 ms



The dynamics of the current limit value controller and the voltage controller is influenced by the setting of the parameter *Dyn. Voltage Pre-Control* **605**.

18.5 Functions of Field-Orientated Control

The field-orientated control modes are based on a cascade control and the calculation of a complex machine model. In the course of the guided commissioning, a map of the connected machine is produced by the parameter identification and transferred to various parameters. Some of these parameters are visible and can be optimized for various operating points.

18.5.1 Current Controller

The inner control loop of the field-orientated control consists of two current controllers. The field-orientated control thus impresses the motor current into the machine via two components to be controlled.

This is done by:

- controlling the flux-forming current value I_{sd}
- controlling the torque-forming current value I_{sq}

By separate controlling of these two parameters, a decoupling of the system equivalent to an externally excited direct current machine is achieved.

The set-up of the two current controllers is identical and enables joint setting of amplification as well as the integral time for both controllers. For this, the parameters *Amplification* **700** and *Integral Time* **701** are available. The proportional and integration component of the current controllers can be switched off by setting the parameters to zero.

Parameter		Settings		
No.	Description	Min.	Max.	Default
700	Amplification	0.00	8.00	0.13
701	Integral Time	0.00 ms	10.00 ms	10.00 ms

The guided commissioning has selected the parameters of the current controller in such a way that they can be used without having to be changed in most applications.

If, in exceptional cases, an optimization of the behavior of the current controllers is to be done, the reference value step-change during the flux-formation phase can be used for this. If parameterized appropriately, the reference value of the flux-forming current components jumps to the value *Current During Flux-Formation* **781** and then changes in a controlled way to the magnetizing current after the expiry of the *Maximum Flux-Formation Time* **780**. The operating point necessary for the adjustment demands the setting of parameter *Minimum Frequency* **418** to 0.00 Hz, as the drive is accelerated after magnetizing. The measurement of the step response, which is defined by the ratio of the currents mentioned, should be done in the motor supply line by means of a measuring current transformer of a sufficient bandwidth.



The internally calculated actual value for the flux-forming current component cannot be output via the analog output for this measurement as the time resolution of the measurement is not sufficient.

To set the parameters of the PI controller, the *Amplification* **700** is increased first until the actual value overshoots distinctly during the control process. Now, the amplification is reduced to about a half again and then the *Integral Time* **701** is synchronized until actual value overshoots slightly during the control process.

The settings of the current controllers should not be too dynamic in order to ensure a sufficient reserve range. The control tends to increased oscillations if the reserve range is reduced.

The dimensioning of the current controller parameters by calculation of the time constant is to be done for a switching frequency of 2 kHz. For other switching frequencies, the values are adapted internally so that the setting can remain unchanged for all switching frequencies. The

dynamic properties of the current controller improve if the switching and scanning frequency increases.

The fixed time interval for the modulation results in the following scanning frequencies of the current controller via parameter *Switching Frequency* **400**.

Settings	
Switching frequency	Scanning Frequency
2 kHz ¹⁾	2 kHz
4 kHz	4 kHz
8 kHz	8 kHz
12 kHz	8 kHz
16 kHz	8 kHz

¹⁾ This switching frequency can only be set for the parameter *Min. Switching Frequency* **401**.

18.5.2 Torque Controller

The torque-controlled configurations 230 and 430 often demand limitation of the speed in the operating points without load moment. The controller increases the speed in order to reach the reference torque until the *Frequency Upper Limit* **767** or the *Frequency Lower Limit* **768** is reached. As from the limit value the drive is controlled to maximum speed, which corresponds to the behavior of the speed controller. Thus, the controller is limited to the *Maximum Frequency* **419**.

Parameter		Settings		
No.	Description	Min.	Max.	Default
767	Frequency Upper Limit	-599.00 Hz	599.00 Hz	599.00 Hz
768	Frequency Lower Limit	-599.00 Hz	599.00 Hz	-599.00 Hz

18.5.2.1 Limit Value Sources

The limitation of the frequency can be done by setting fixed values and also by linking to an analog input parameter. The analog value is limited via parameters *Minimum Reference Percentage* **518** and *Maximum Reference Percentage* **519**, but does not consider the *Gradient Percentage Ramp* **477** of the reference percentage value channel.

The assignment is done for the torque controller via parameters *Frequency Upper Limit Source* **769** and *Frequency Lower Limit Source* **770**.

<i>Operation mode</i> 769, 770	Function
101 - Analog Input MFI1A	The source is the multifunctional input 1 in an analog <i>Operation Mode</i> 452 .
110 - Fixed Limit	The selected parameter values are taken into account to limit the speed controller.
201 - Inv. Analog Input MFI1A	Operation mode 101, inverted.
210 - Inv. Fixed Limit	Operation mode 110, inverted.

18.5.3 Speed controller

The source of the actual speed value is selected via parameter *Actual Speed Source* **766**. By default, speed sensor 1 is used as the actual speed source. If speed sensor 2 of an extension module is to deliver the actual value signal for the speed controller, speed sensor 2 must be selected as the source.

<i>Actual Speed Source</i> 766	Function
1 - Speed Sensor 1	The actual speed source is speed sensor 1 of the basic device (factory setting).
2 - Speed Sensor 2	The actual speed source is speed sensor 2 of an extension module. ¹⁾

¹⁾ Only available if extension module is installed

The control of the torque-forming current components is done in the outer control loop by the speed controller. Via parameter *Operation Mode* **720**, you can select the operation mode for the speed controller. The operation mode defines the use of the parameterizable limits. These are referred to the direction of rotation and the direction of the torque and depend on the selected configuration.

<i>Operation mode</i> 720	Function
0 - Speed Controller Off	The controller is deactivated or the torque-forming component is zero.
1 - Limits for Motor / Generator	The limitation of the speed controller assigns the upper limit to the motor operation of the drive. Independent of the direction of rotation, the same limit is used. The same applies in the case of regenerative operation with the lower limit.
2 - Limits for pos. / neg. Torque	The assignment of the limit is done by the sign of the value to be limited. Independent of the motor or generator operating points of the drive, the positive limitation is done by the upper limit. The lower limit is regarded as a negative limitation.

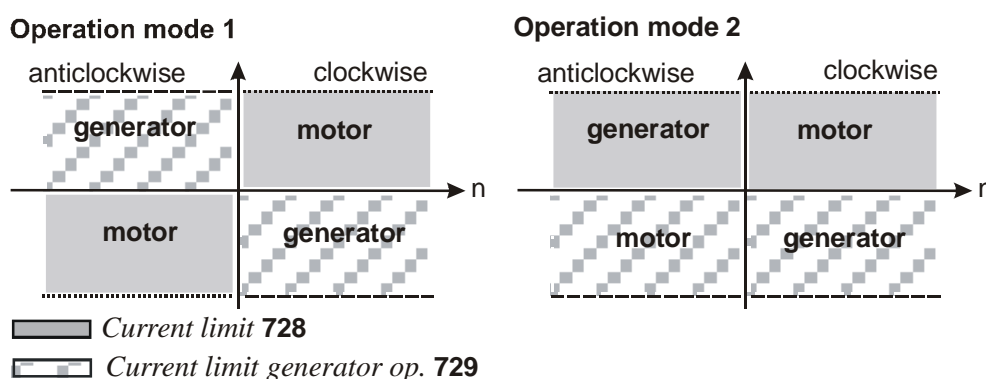

The properties of the speed controller can be adapted for adjustment and optimization of the controller. The amplification and integral time of the speed controller are to be set via parameters *Amplification 1* **721** and *Integral Time 1* **722**. For the second speed range, parameters *Amplification 2* **723**, *Integral Time 2* **724** can be set. The distinction between the speed ranges is done by the value selected via parameter *Speed Control Switch-Over Limit* **738**. The parameters *Amplification 1* **721** and *Integral time 1* **722** are taken into account in the case of the default parameter *Speed Control Switch-Over Limit* **738**. If parameter *Speed Control Switch-Over Limit* **738** is set to a value higher than 0.00 Hz, parameters *Amplification 1* **721**, *Integral Time 1* **722** are active below the limit and parameters *Amplification 2* **723**, *Integral Time 2* **724** are active above the limit.

The control deviation can be filtered with the *filter time constant* **754** if necessary. Therefore, the operation with static control deviation with occasional undesired deviations can be stabilized, while at the same time the dynamic behavior in load change operation (speed change or changing torque demand) suffers.

The parameterized amplification at the current operating point can additionally be assessed via the parameter *Backlash Damping* **748** depending on the control deviation. In particular the small signal behavior in applications with a gearbox can be improved by a value higher than zero percent.

The parameter *Backlash damping* **748** is available depending on the device type.

Parameter		Settings		
No.	Description	Min.	Max.	Default
721	Amplification 1	0.00	200.00	- ¹⁾
722	Integral Time 1	0 ms	60000 ms	- ¹⁾
723	Amplification 2	0.00	200.00	- ¹⁾
724	Integral Time 2	0 ms	60000 ms	- ¹⁾
754	Filter time constant	0 ms	128 ms	0 ms
738	Speed Control Switch-Over Limit	0.00 Hz	599.00 Hz	55.00 Hz
748	Backlash Damping	0 %	300 %	100 %

¹⁾ The default setting is relative to the recommended machine data for the amplification and integral time. This enables a first function test in a large number of applications. The distinction of the parameter settings 1 or 2 for the current frequency range is done by the software according to the selected limit value.

The optimization of the speed controller can be done with the help of a reference value step-change. The amount of the step-change is defined by the set ramp or limitation. The optimization of the PI controller should be done at the maximum admissible reference value change rate. First, the amplification is increased until the actual value overshoots distinctly during the control process. This is indicated by a strong oscillation of the speed and by the running noises. In the next step, reduce the amplification slightly (1/2 ...3/4 etc.). Then reduce the integral time (larger I component) until the actual value overshoots only slightly in the control process. If necessary, check the speed control settings in the case of dynamic operations (acceleration, deceleration). The frequency at which a switch-over of the controller parameters is effected can be set via parameter *Speed Control Switch-Over Limit* **738**.

18.5.3.1 Limitation of Speed Controller

The output signal of the speed controller is the torque-forming current component I_{sq} . The output and the I component of the speed controller can be limited via parameters *Current Limit* **728**, *Current Limit Generator Operation* **729**, *Torque Limit* **730**, *Torque Limit Generator Operation* **731** or *Power Limit* **739**, *Power Limit Generator Operation* **740**. The limits of the proportional component are set via parameter *P-Comp. Torque Upper Limit* **732** and parameter *P-Comp. Torque Lower Limit* **733**.

- The output value of the controller is limited by an upper and a lower current limit, parameter *Current Limit* **728** and parameter *Current Limit Generator Op.* **729**. The limit values are entered in Amperes. The current limits of the controller can be linked to the fixed limits and analog input parameters. The assignment is done via the parameters *Isq Limit Source Motor Op.* **734** and *Isq Limit Source Generator Op.* **735**.
- The output value of the controller is limited by an upper and a lower torque limit, parameter *Torque Limit* **730** and parameter *Torque Limit Generator Op.* **731**. The limit values are input as a percentage of the rated motor torque. The assignment of fixed values or analog limit values is done via the parameters *Torque Limit Source Motor Op.* **736** and *Torque Limit Source Gen. Op.* **737**.
- The output value of the P component is limited with parameter *P-Comp. Torque Upper Limit* **732** and *P-Comp. Torque Lower Limit* **733**. The limit values are input as torque limits as a percentage of the rated motor torque.

- The power output by the motor is proportional to the product of speed and torque. This output power can be limited at the controller output with a *Power Limit 739* and *Power Limit Generator Operation 740*. The power limits are entered in kW.

Parameter		Settings		
No.	Description	Min.	Max.	Default
728	Current Limit	0.0 A	$0 \cdot I_{FIN}$	$0 \cdot I_{FIN}$
729	Current Limit Generator Operation	-0.1 A	$0 \cdot I_{FIN}$	$0 \cdot I_{FIN}$
730	Torque Limit	0.00 %	650.00 %	650.00 %
731	Torque Limit Generator Operation	0.00 %	650.00 %	650.00 %
732	P-Comp. Torque Upper Limit	0.00 %	650.00 %	100.00 %
733	P-Comp. Torque Lower Limit	0.00 %	650.00 %	100.00 %
739	Power Limit	0.00 kW	$2 \cdot 0 \cdot P_{FIN}$	$2 \cdot 0 \cdot P_{FIN}$
740	Power Limit Generator Operation	0.00 kW	$2 \cdot 0 \cdot P_{FIN}$	$2 \cdot 0 \cdot P_{FIN}$

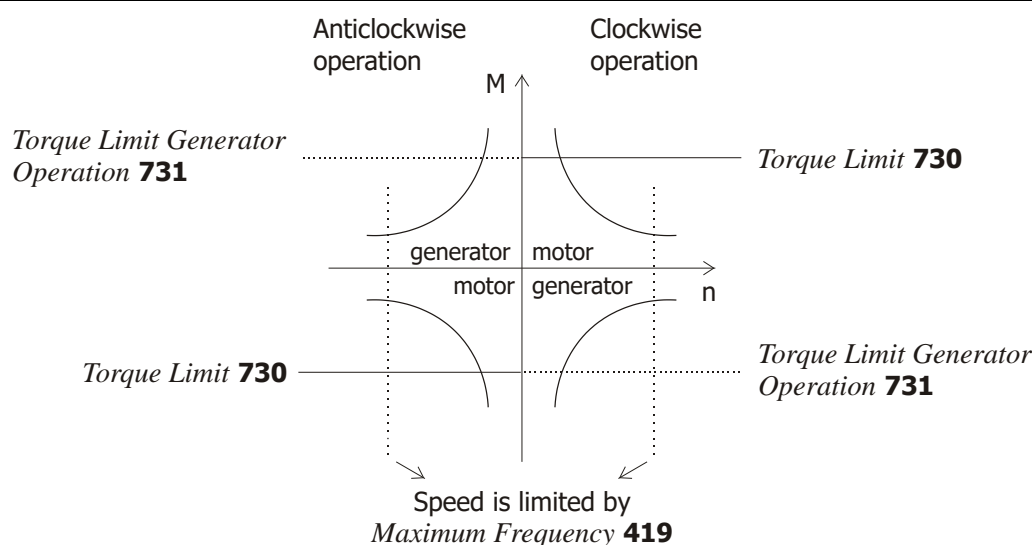

18.5.3.2 Limit Value Sources

As an alternative to limiting the output values by a fixed value, linking to an analog input value is also possible. The analog value is limited via parameters *Minimum Reference Percentage 518* and *Maximum Reference Percentage 519*, but does not consider the *Gradient Percentage Ramp 477* of the reference percentage value channel.

The assignment is done with the help of the parameters *Isq Limit Source Motor Operation 734* and *Isq Limit Source Generator Op. 735* for the torque-forming current component Isq.

The sources for torque limits are selectable via parameters *Torque Limit Source Motor Op 736* and *Torque Limit Source Gen. Op. 737*

Operation mode 736, 737	Function
101 - Analog Input MFI1A	The source is the multifunctional input 1 in an analog <i>Operation Mode 452</i> .
105 - Rep. Frequency Input (F3)	The frequency signal on the repetition frequency input corresponding to <i>Operation Mode 496</i> .
110 - Fixed Limit	The selected parameter values for limiting the speed controller are taken into account.



The limit values and assignment to different limit value sources are data set related in the configurations. The use of the data set change-over demands an examination of the parameters in question.

18.5.4 Acceleration Pre-Control

The acceleration pre-control is active in the speed-controlled configurations and can be activated via parameter *Operation Mode* **725** for acceleration pre-control.

<i>Operation Mode</i> 725		Function
0 -	Off	The control system is not influenced.
1 -	Switched on	The acceleration pre-control is active according to the limit values.

The acceleration pre-control controlled parallel to the speed controller reduces the reaction time of the drive system to a change of reference values. The minimum acceleration time defines the modification speed of the reference speed value as from which a torque necessary for acceleration of the drive is pre-controlled. The acceleration of the mass is a function of the *Mech. Time Constant* **727** of the system. The value calculated from the increase of the reference value and the multiplication factor of the torque required is added to the output signal of the speed controller.

Parameter		Settings		
No.	Description	Min.	Max.	Default
726	Minimum Acceleration	0.1 Hz/s	6500.0 Hz/s	1.0 Hz/s
727	Mech. Time Constant	1 ms	60000 ms	10 ms

For optimal setting, the acceleration pre-control is switched on and the mechanical time constant is set to the minimum value. The output value of the speed controller is compared to the minimum acceleration time during the acceleration processes. The frequency ramp is to be set to the highest value occurring in operation at which the output value of the speed controller is not yet limited. Now, the value of the *Minimum Acceleration* **726** is set to half the set acceleration ramp so that it is ensured that the acceleration pre-control is active. The acceleration pre-control is not raised by increasing the *Mech. Time Constant* **727** until the output values corresponds to the time modification of the drive during the acceleration processes.

18.5.5 Field Controller

The flux-forming current component is controlled by the field controller. The guided commissioning optimizes the parameters of the field controller by measuring the time constant and magnetizing curve of the connected 3-phase machine. The parameters of the field controller are selected such that they can be used without changes in most applications. The proportional and the integrating part of the field controller are to be set via parameters *Amplification* **741** and *Integral Time* **742**.

Parameter		Settings		
No.	Description	Min.	Max.	Default
717	Reference Flux	0.01 %	300.00 %	100.00 %
741	Amplification	0.0	100.0	5.0
742	Integral Time	0.0 ms	1000.0 ms	100.0 ms

Please note, that changes within the Field controller parameters should only be done in the basic speed area.

When an optimization of the Field controller is necessary, set the *Integral Time* **742** = *Act. Rotor Time Constant* **227** / 2, meaning to the half of the rotor time constant. In most application cases, this change is sufficient.

When further optimizations are necessary, follow the step described in the following procedure.

- Set the output frequency in a way (i.e. via the frequency reference value), that the actual value *Modulation* **223** = 80...90 % *Reference Modulation* **750**.

- Now change the *Flux Reference Value* **717** from 100 % to 90 %. Oscillograph the actuating variable I_{sd} . The course of the signal of the flux-forming current I_{sd} should reach the stationary value after overshooting without oscillation.
- Change the parameters *Amplification* **741** and *Integral Time* **742** according to the application requirements.
- Change the *Flux Reference Value* **717** back to 100 % und repeat the flux reference step while you can analyze the changes with the oscillograph. Repeat these steps if necessary.

If a quick transition into field weakening is necessary for the application, the integral time should be reduced. Increase the *Amplification* **741** in order to achieve a good dynamism of the controller.

An increased overshoot is necessary for a good control behavior in controlling of a load with low-pass behavior, e.g. an asynchronous motor.

18.5.5.1 Limitation of field controller

The output signal of the field controller, the integrating and proportional components are limited via parameter *Ref. Isd Upper Limit* **743** and parameter *Ref. Isd Lower Limit* **744**. The guided commissioning has set the parameter *Ref. Isd Upper Limit* **743** according to the parameter *Rated Current* **371**.

Parameter		Settings		
No.	Description	Min.	Max.	Default
743	Ref. Isd Upper Limit	$0.1 \cdot I_{FIN}$	$0 \cdot I_{FIN}$	I_{FIN}
744	Ref. Isd Lower Limit	$- I_{FIN}$	I_{FIN}	0.0

The limits of the field controller define not only the maximum current occurring, but also the dynamic properties of the controller. The upper and lower limits restrict the modification speed of the machine flux and the torque resulting from it. In particular the speed area above the nominal frequency should be observed for the modification of the flux-forming component. The upper limit is to be estimated from the product of the set magnetizing current and the correction factor *Reference Flux* **717**, although the limit must not exceed the overload current of the drive.

18.5.6 Modulation Controller

The modulation controller, which is designed as an I regulator, automatically adapts the output value of the frequency inverter to the machine behavior in the basic speed area and in the field weakening area. If the modulation exceeds the value set with parameter *Reference Modulation* **750**, the field-forming current component and thus the flux in the machine are reduced.

In order to make the best possible use of the voltage available, the figure selected via parameter *Operation mode* **753** is put into proportion to the DC link voltage. That means that with a high mains voltage there is also a high output voltage available, the drive only reaches the field weakening area later and produces a higher torque.

<i>Operation mode</i> 753	Function
0 - Usq-Control	The modulation is calculated from the ratio of torque-forming voltage component U_{sq} to the DC link voltage.
1 - V-Absolute Value Control	The modulation is calculated from the absolute voltage value to the DC link voltage ratio.

The integrating part of the modulation controller is to be set via parameter *Integral Time* **752**.

Parameter		Settings		
No.	Description	Min.	Max.	Default
750	Reference Modulation	3.00 %	105.00 %	102.00 %

752	Integral Time	0.0 ms	1000.0 ms	10.0 ms
-----	---------------	--------	-----------	---------

The percentage setting of the *Reference Modulation* **750** is basically depending on the leakage inductivity of the machine. The default value was selected such that in most cases the remaining deviation of 5% is sufficient as a reserve range for the current controller. For the optimization of the controller parameters, the drive is accelerated with a flat ramp into the area of field weakening, so that the modulation controller intervenes. The limit is set via parameter *Reference Modulation* **750**. Then, the control loop can be excited with a unit step function by modifying the reference modulation (change-over between 95% and 50%). By means of an oscillographed measurement of the flux-forming current component on the analog output of the frequency inverter, the controlling process of the modulation controller can be assessed. The course of the signal of the flux-forming current I_{sd} should reach the stationary value after overshooting without oscillation. An oscillating of the course of the current can be damped by increasing the integral time. The parameter *Integral Time* **752** should roughly correspond to the actual value *Act. Rotor Time Constant* **227**.

18.5.6.1 Limitation of Modulation Controller

The output signal of the modulation controller is the internal reference flux. The controller output and the integrating part are limited via the parameter *Reference Imr Lower Limit* **755** and the product of *Rated Magnetizing Current* **716** with *Reference Flux* **717**. The magnetizing current parameter forming the upper limit is to be set to the rated value of the machine. For the lower limit, select a value which also builds up an adequate flux in the machine in the field weakening area. The limitation of the control deviation at the output of the modulation controller prevents a possible oscillation of the control loop in the case of load surges. The parameter *Control Deviation Limitation* **756** is stated as an absolute value and acts both as a positive and a negative limit.

Parameter		Settings		
No.	Description	Min.	Max.	Default
755	Reference Imr Lower Limit	$0.01 \cdot I_{FIN}$	$0 \cdot I_{FIN}$	$0.01 \cdot I_{FIN}$
756	Control Deviation Limitation	0.00 %	100.00 %	10.00 %

19 Special Functions

The configurable functions of the corresponding control methods enable another field of application of the frequency inverters. The integration in the application is made easier by special functions.

19.1 Pulse Width Modulation

The motor noises can be reduced by changing over the parameter *Switching Frequency* **400**. The maximum reduction of the switching frequency should not exceed a ratio of 1:10 to the frequency of the output signal for a sine-shaped output signal. The maximum possible switching frequency depends on the drive output and the ambient conditions. For the required technical data refer to the corresponding table and the device type diagrams.

Parameter		Settings		
No.	Description	Min.	Max.	Default
400	Switching frequency	2 kHz	16 kHz	2 kHz ¹⁾ 4 kHz ²⁾

The factory setting of parameter *Switching frequency* **400** depends on the setting of parameter *Configuration* **30**:

¹⁾ configurations 1xx

²⁾ configurations 2xx / 4xx/ 5xx

The heat losses increase proportionally to the load point of the frequency inverter and the switching frequency. The automatic reduction adjusts the switching frequency to the current operating state of the frequency inverter in order to provide the output performance required for the drive task at the greatest possible dynamics and a low noise level.

The switching frequency is adjusted between the limits which can be set via parameters *Switching frequency* **400** and *Min. Switching Frequency* **401**. If the *Min. Switching Frequency* **401** is larger than or equal to the *Switching Frequency* **400**, the automatic reduction is deactivated.

Parameter		Settings		
No.	Description	Min.	Max.	Default
401	Min. Switching Frequency	2 kHz	16 kHz	2 kHz

The change of the switching frequency depends on the heat sink temperature switch-off limit and the output current.

The temperature limit to be exceeded so that the switching frequency is reduced can be set via parameter *Reduction Limit Heat Sink Temp.* **580**. If the heat sink temperature falls below the threshold set via parameter *Reduction Limit Heat Sink Temp.* **580** by 5 °C, the switching frequency is increased again step by step.

Parameter		Settings		
No.	Description	Min.	Max.	Default
580	Reduction Limit Heat Sink Temp.	-25 °C	0 °C	-4 °C



The limit for the switching frequency reduction is influenced by the intelligent current limits depending on the selected *Operation Mode* **573** and the output current. If they have been switched off or provide the full overload current, the switching frequency is reduced when the output current exceeds the limit of 87.5% of the long-term overload current (60s). The switching frequency is increased if the output current drops below the reference current of the next highest switching frequency.

19.2 Fan

The switch-on temperature of the heat sink fan can be set with the parameter *Switch-on temperature* **39**.

If mains voltage is applied to the frequency inverter, and the heat sink temperature exceeds the set temperature, the heat sink fan is switched on. Independent from parameter *Switch-on temperature* **39**, the heat sink fan will be switched on as soon as the frequency inverter is switched on and enabled and the start signal is received.

If the heat sink temperature drops below the set temperature by 5 °C, or if the controller enable signal is inhibited, the heat sink fan is switched off when the minimum ON-time has elapsed.

The minimum ON-time of the heat sink fan is set internally to 1 minute. When the temperature drops below the *Switch-on temperature* **39** during this time since starting, the fan will continue to operate until the running ON-time is reached.

Operation mode 43 for digital outputs additionally enables the control of an **external** fan. Via the digital output, the fan is switched on if the controller is released and Start clockwise or Start anticlockwise are switched on, or if the *Switch-on temperature* **39** for the internal fan was reached.

Like in the case of the internal heat sink fan, the minimum ON-time of the external fan is 1 minute.

Parameter		Settings		
No.	Description	Min.	Max.	Default
39	Switch-On Temperature	0 °C	60 °C	0 °C

19.3 Bus controller



In order to be able to control the drive, the digital controller input S1IND must be connected and set to "High-Signal" in order to enable the output stage.

The frequency inverters can be extended by different options for data communication and can be integrated in an automation and control system in this way. Parameterization and commissioning can be done via the optional communication card, the operating unit or the interface adapter. The parameter *Local/Remote* **412** defines the operating behavior and enables a change between the control via contacts or the control unit and/or the interface.

<i>Local/Remote</i> 412	Function
0 - Control via Contacts	The Start and Stop commands as well as the direction of rotation are controlled via digital signals.
1 - Control via Statemachine	The Start and Stop commands as well as the direction of rotation are controlled via the DRIVECOM State machine of the communication interface.
2 - Control via remote contacts	The Start and Stop commands as well as the direction of rotation are controlled via logic signals through the communication protocol.
3 - Control via Keypad, direction of rot. via contacts	The Start and Stop commands are controlled from the control unit and the direction of rotation is controlled via digital signals.
4 - Cont. via KP or Cont., direction of rot. via cont.	The Start and Stop commands are controlled from the control unit or via digital signals. The direction of rotation is controlled via digital signals only.
5 - Ctrl. 3-Wire, direction Cont.	3-wire; control of direction of rotation and signal 3-Wire Control 87 via contacts.
13 - Control via KP, direction of rot. via KP	The Start and Stop commands as well as the direction of rotation are controlled via the control unit.

Local/Remote 412		Function
14 -	Control via KP + cont., direction of rot. via contact	The Start and Stop commands are controlled from the control unit or via digital signals. The direction of rotation is controlled via the control unit only.
20 -	Control via contacts, clockwise rot. only	The Start and Stop commands are controlled via digital signals. Fixed direction of rotation, clockwise rotation only.
23 -	Control via keypad, clockwise rot. only	The start and stop commands are controlled via keypad. Fixed direction of rotation, clockwise rotation only.
24 -	Control via cont. +KP, clockwise rot. only	The Start and Stop commands are controlled from the control unit or via digital signals. Fixed direction of rotation, clockwise rotation only.
30 to 34		Operation mode 20 to 24, anticlockwise direction of rotation only.
43 -	Control via KP, direction of rot. via contact + KP	The start and stop commands are controlled via digital signals. The direction of rotation is controlled from the control unit or via digital signals.
44 -	Control via cont.+ KP, direction of rot. via cont. + KP	Both the Start and Stop commands as well as the sense of rotation can be controlled from either the control unit or via digital signals.
46 -	Ctrl. 3-Wire + KP, Dir. Cont. + KP	3-wire and control unit; control of direction of rotation and signal 3-Wire Control 87 via contacts or control unit.

19.4 Brake Chopper and Brake Resistance

The frequency inverters feature a brake chopper transistor. The external brake resistor is connected to terminals Rb1 and Rb2. The parameter *Trigger Threshold* **506** defines the switch-on threshold of the brake chopper. The generator output of the drive, which leads to the increase in the DC link voltage, is converted to heat by the external brake resistor above the limit set via parameter *Trigger Threshold* **506**.

Parameter		Settings			
No.	Description	ACT	Min.	Max.	Default
506	Trigger threshold	210	225	1000.0 V	390
		410	425		780

The parameter *Trigger Threshold* **506** is to be set in such a way that it is between the maximum DC link voltage which the mains can generate and the maximum admissible DC link voltage of the frequency inverter.

$$U_{\text{Netz}} \cdot 1.1 \cdot \sqrt{2} < Ud_{\text{BC}} < Ud_{\text{max}}$$

If the parameter *Trigger Threshold* **506** is set larger than the maximum admissible DC link voltage, the brake chopper cannot become active, the brake chopper is switched off.

If the parameter *Trigger Threshold* **506** is set to a value below the DC link voltage generated by the mains, error message F0705 (chapter 21.1.1 "Error Messages") is displayed if the start command is issued to the frequency inverter.

If the DC link voltage exceeds the maximum values of 400 V for the ACT210 series of devices and 800 V for the ACT410 series of devices, respectively, error message F0700 is displayed (chapter 21.1.1 "Error Messages").

The sampling period of the function is 125 μ s.

After exceeding the trigger threshold, the brake chopper remains in switched-on condition for at least 125 μ s, even if the DC link voltage will fall below the trigger threshold in this time.

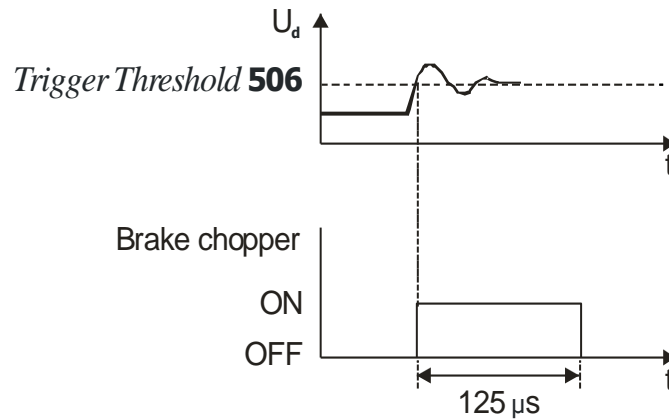

19.4.1 Dimensioning of Brake Resistor

The following values must be known for dimensioning:

- Peak braking power $P_{b \text{ Peak}}$ in W
- Resistance R_b in Ω
- Duty cycle DC in %

Calculation of peak braking power $P_b \text{ Peak}$

$$P_{b \text{ Peak}} = \frac{J \cdot (n_1^2 - n_2^2)}{182 \cdot t_b}$$

$P_{b \text{ Peak}}$	=	Peak braking power in W
J	=	Moment of inertia of drive system kgm^2
n_1	=	Speed of drive system before the braking operation in min^{-1}
n_2	=	Speed of drive system after the braking operation in min^{-1}
t_b	=	Braking time in s

Calculation of resistance R_b

$$R_b = \frac{U_{d \text{ BC}}^2}{P_{b \text{ Peak}}}$$

R_b	=	Resistance in Ω
$U_{d \text{ BC}}$	=	Switch-on threshold in V
$P_{b \text{ Peak}}$	=	Peak braking power in W

The switch-on threshold $U_{d \text{ BC}}$ is the DC link voltage at which the brake resistor is switched on. The switch-on threshold can be set, as described above, via parameter *Trigger Threshold* **506**.

CAUTION

Device damage!

Inappropriate resistance values may result in device damage.



- The resistance of the brake resistor must not be less than the minimum value $R_{b \text{ min}} - 10\%$. The values for $R_{b \text{ min}}$ are listed in chapter 5 "Technical Data".

If the calculated resistance R_b of the brake resistor is between two standard series values, the lower resistance is to be selected.

Calculation of duty cycle DC

$$DC = \frac{t_b}{t_{\text{cycle}}}$$

DC	=	Duty cycle
t_b	=	Braking time
t_{cycle}	=	Cycle time

Example:
 $t_b = 48 \text{ s}$, $t_{\text{cycle}} = 120 \text{ s}$

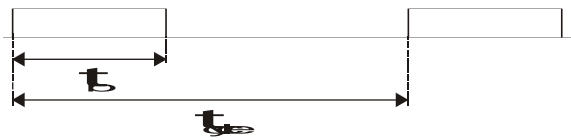

$$DC = \frac{t_b}{t_{cycle}} = 0.4 = 40\%$$

In the case of infrequent short braking operations, typical values of the duty cycle DC are at 10 %, for long braking operations (≥ 120 s) typical values are at 100%. In the case of frequent deceleration and acceleration operations, it is recommended that the duty cycle DC be calculated according to the above formula.

The calculated values for $P_{b\ Peak}$, R_b and DC can be used by the resistor manufacturers for determining the resistor-specific permanent power.



The brake resistor is to be connected according to the specifications and instructions in chapter 7.4.4 "Connection of a Brake Resistor".

19.5 Motor Circuit Breaker

Motor circuit breakers are used for protecting a motor and its supply cable against overheating by overload. Depending on the overload level, they disconnect the motor from mains supply immediately in the case of a short-circuit or they disconnect the motor if an overload has occurred for some time.

Conventional motor circuit breakers are commercially available for various applications with different trigger characteristics (L, G/U, R and K), as shown in the diagram on the right. As frequency inverters in most cases are used for supplying motors which are classified as operating equipment with very high starting currents, exclusively the K characteristic was realized in this function.

Unlike the operation of a conventional motor Protection switch which disconnects the equipment to be protected immediately if the trigger threshold is reached, this function provides the possibility of issuing a warning instead of disconnecting the equipment immediately.

The rated current of the motor protection switch refers to the rated motor current stated via parameter *Rated Current* **371** of the corresponding data set.

The rated values of the frequency inverter are to be considered accordingly when it comes to dimensioning the application.

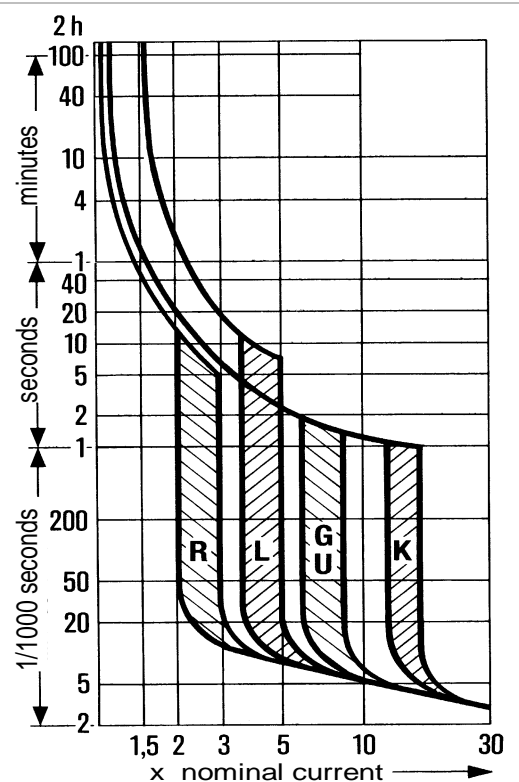

The function of the motor circuit breaker can be linked to different data sets. In this way, it is possible to operate different motors via one frequency inverter. Thus, each motor can be equipped with its own motor protection switch.

In case a motor is operated via the frequency inverter for which some setting values, e.g. minimum and maximum frequency, are changed via the data set switch-over, only one motor circuit breaker may be installed. This functionality can be differentiated by selecting the parameter *Operation Mode* **571** for single motor operation or multiple motor operation.

<i>Operation Mode</i> 571	Function
0 - Off	The function is deactivated
1 - K-Char.,Mul.Motor Op.,Err.Sw.Off	In each of the four data sets, the rated values are monitored. Overloading the drive is prevented by the fault switch-off "F0401".
2 - K-Char.,Sing.Motor,Err.Sw.-Off	The rated values in the first data set are used independently of the active data set. Overloading the drive is prevented by the fault switch-off "F0401".
11 - K-Char.,Multi-Motor Op.,Warning	In each of the four data sets, the rated values are monitored. Overloading the drive mechanism is signaled by a warning message "A0200".
22 - K-Char.,Single-Motor,Warning	The rated values in the first data set are used independently of the active data set. Overloading the drive mechanism is signaled by a warning message "A0200".
101 K-Char.,Multi-Motor Op., Err.Sw.Off, - Latching	Like operation modes 1, 2, 11 or 22 In addition, the integrated current will be saved permanently when the device is turned off and set to the saved value upon restart.
102 K-Char.,Single-Motor Op., Err.Sw.Off, - Latching	
111 K-Char.,Multi-Motor Op.,Warning, - Latching	
122 K-Char.,Single-Motor, Warning, Latch- - ing	

Multiple motor operation

Parameter *Operation Mode* **571** = 1, 11, 101 or 111

In multiple motor operation, it is assumed that each data set is assigned to a corresponding motor. For this, one motor and one motor circuit breaker are assigned to each data set. In this operation mode, the rated values of the active data set are monitored. The current output current of the frequency inverter is only taken into account in the motor circuit breaker activated by the data set. In the motor circuit breakers of the other data sets, zero current is expected, with the result that the thermal decay functions are taken into account. In combination with the data set change-over, the function of the motor circuit breakers is similar to that of motors connected alternately to the mains with their own circuit breakers.

In addition, in Operation Modes 101 and 111, the integrated current will be saved permanently when the device is turned off and set to the saved value upon restart.

Single motor operation

Parameter *Operation Mode* **571** = 2, 22, 102 or 122

In single motor operation, only one motor circuit breaker, which monitors the output current of the frequency inverter, is active. In the case of a data set change-over, only the switch-off limits derived from the rated machine parameters are changed over. Accumulated thermal values are used after the change-over as well. In the case of the data set change-over, please ensure that the machine data are stated identically for all data sets. In combination with the data set change-over, the function of the motor circuit breaker is similar to that of motors connected alternately to the mains with one common circuit breaker.

In addition, in Operation Modes 102 and 122, the integrated current will be saved permanently when the device is turned off and set to the saved value upon restart.

Reset-proof

Parameter *Operation Mode* **571** = 101, 102, 111 or 122.

The internal state of the motor circuit breaker is saved permanently (reset-proof). These settings are to be used in the case of regular short-time mains failure/disconnection. This guarantees correct motor protection for the application even in the case of short-time mains failure/disconnection.

Motor protection, in particular self-ventilation motors, is improved via *Frequency Limit 572* which can be set as a percentage of the rated frequency.

Parameter		Setting		
No.	Description	Min.	Max.	Factory setting
572	Frequency Limit	0%	300%	0%

Output signals

Digital signals signal that of the function "motor circuit breaker" has been triggered.

180 -	Warning Motor Protection	1)	Triggering of "motor circuit breaker" function as per <i>Operation Mode 571</i> is reported.
14 -		2)	

1) For linking to frequency inverter functions

2) For output via a digital output.



In Operation Modes 101, 102, 111 and 122, the function set in parameter *Operation Mode 571* should be the same in all data sets.

In the calculation of the triggering time, the output current measured in working points below the frequency limit will be valued at a factor between 1 and 2.

This factor is determined depending on the stator frequency. In this way, the higher thermal load of self-ventilated motors in the lower speed range is considered.

The table shows an extract of the factors for a 50 Hz motor.

		← <i>Frequency Limit 572</i> →								
		300%	200%	150%	100%	80%	60%	40%	20%	10%
Stator frequency [Hz]	0	200%	200%	200%	200%	200%	200%	200%	200%	200%
	5	188%	182%	177%	168%	162%	153%	139%	114%	100%
	10	177%	168%	160%	147%	139%	129%	114%	100%	100%
	20	160%	147%	137%	122%	114%	106%	100%	100%	100%
	30	147%	132%	122%	109%	103%	100%	100%	100%	100%
	50	129%	114%	106%	100%	100%	100%	100%	100%	100%
	100	106%	100%	100%	100%	100%	100%	100%	100%	100%
150	100%	100%	100%	100%	100%	100%	100%	100%	100%	

19.6 V-belt Monitoring

Continuous monitoring of the load behavior and thus of the connection between the 3-phase machine and the load is the task of the V-belt monitoring system. The parameter *Operation Mode 581* defines the function behavior if the *Active Current 214* (sensor-less control) or the torque-forming current component *Isq 216* (field-oriented control method) is below the set *Trigger Limit Iactive 582* for longer than the parameterized *Delay Time 583*.

<i>Operation mode 581</i>	Function
0 - Off	The function is deactivated.
1 - Warning	If the active current drops below the threshold value, the warning "A8000" is displayed.
2 - Error	The unloaded drive is switched off and fault message "F0402" is displayed.

The error and warning messages can be read out by means of the digital outputs or reported to an overriding control system. The *Trigger Limit Iactive 582* is to be parameterized as a percentage of the *Rated Current 371* for the application and the possible operating points.

Parameter		Settings		
No.	Description	Min.	Max.	Default
582	Trigger Limit Iactive	0.1%	100.0 %	10.0 %
583	Delay Time	0.1 s	600.0 s	10.0 s

19.7 Functions of Field-Orientated Control

The field-orientated control modes are based on a cascade control and the calculation of a complex machine model. The various control functions can be supplemented by special functions specific to the application.

19.7.1 Motor Chopper

The field-orientated control modes contain the function for adapted implementation of the generator energy into heat in the connected three-phase machine. This enables the realization of dynamic speed changes at minimum system costs. The torque and speed behavior of the drive system is not influenced by the parameterized braking behavior. The parameter *Trigger Threshold* **507** of the DC link voltage defines the switch-on threshold of the motor chopper function.

Parameter		Settings			
No.	Description	ACT	Min.	Max.	Default.
507	Trigger threshold	210	225	1000.0 V	400
		410	425		800

The parameter *Trigger Threshold* **507** is to be set in such a way that it is between the maximum DC link voltage which the mains can generate and the maximum admissible DC link voltage of the frequency inverter.

$$U_{\text{Mains}} \cdot 1.1 \cdot \sqrt{2} < U_{\text{dMC}} < U_{\text{dmax}}$$

If the parameter *Trigger Threshold* **507** is set larger than the maximum admissible DC link voltage, the motor chopper cannot become active, the motor chopper is switched off.

If the set *Trigger Threshold* **507** is smaller than the maximum DC link voltage the mains can generate, error message F0706 (chapter 21.1.1 "Error Messages") is displayed when the frequency inverter is switched on.



The motor chopper function only works if activated via voltage Controller *Operation Mode* **670**. See chapter 18.2 "Voltage controller".



For synchronous motors (*Configuration* **30** = 5xx), the motor chopper function is deactivated to prevent damages to the motor. The other functions of the voltage controller are not affected by this.

19.7.2 Temperature Adjustment

The field-orientated control modes are based on the most precise calculation of the machine model possible. The rotor time constant is an important machine variable for the calculation. The value to be read out via the parameter *Act. Rotor Time Constant* **227** is calculated from the inductivity of the rotor circuit and the rotor resistance. The dependence of the rotor time constant on the motor temperature can be considered in the case of particularly high precision requirements via a suitable measurement. Via *Operation Mode* **465** for the temperature adjustment, you can select different methods and actual value sources for temperature measurement.

<i>Operation mode 465</i>	Function
0 - Off	The function is deactivated.
1 - Temp. Meas. on MFI1A	Temperature synchronization (0 ... 200 °C => 0 ... 10 V / 0 ... 20 mA), actual temperature value at multifunctional input 1.
4 - Temp. Meas. at Start	Determination of temperature by frequency inverter via measurement of the winding resistance without external temperature measurement.

Operation mode 1 requires an external temperature measurement system which evaluates the temperature sensor and maps the temperature range from 0...200 °C to an analog voltage or current signal. The *Operation Mode 452* of multifunction input MFI1 must be selected accordingly.

Operation mode 4 is available in configurations 210 and 230. When the signals Controller release and Start clockwise or Start anticlockwise are present, the motor temperature and the rotor time constant are synchronized by means of the measured winding resistance.

The material used for the rotor winding of the motor is considered via the parameter *Temperature Coefficient 466*. This value defines the change of the rotor resistance as a function of the temperature for a certain material of the rotor winding. Typical temperature coefficients are 39%/100 °C for copper and 36%/100 °C for aluminum at a temperature of 20°C.

The temperature characteristic within the software is calculated via the aforementioned temperature coefficient and the parameter *Temperature Adjustment 467*. The adjustment temperature enables an additional optimization of the rotor time constant alongside the parameter *Rated Slip Correction Factor 718*.

Parameter		Settings		
No.	Description	Min.	Max.	Default
466	Temperature Coefficient	0.00%/100 °C	300.00%/100 °C	39.00%/100 °C
467	Adjusting Temperature	-50 °C	300 °C	35 °C

The synchronization of the rotor time constant as a function of the winding temperature can be adjusted. The default values should normally be sufficiently precise so that neither an adjustment of the rotor time constants via the parameter *Rated Slip Correction Factor 718* nor an adjustment of the temperature synchronization via the parameter *Temperature Coefficient 466* is necessary. If an adjustment is necessary, please remember that the rotor time constant is calculated by the guided commissioning via the machine data. The *Adjusting Temperature 467* is to be set to the temperature at which the optimization of the extended machine data was carried out. The temperature can be read out via the actual value parameter *Winding Temperature 226* and can be used in the optimization for the parameter.

19.7.3 Encoder Monitoring

Failures of the speed sensor lead to a faulty behavior of the drive, as the measured speed forms the foundation of the control mode. By default, the speed sensor monitoring system continuously monitors the speed sensor signal, the track signal and the division marks. If, while the frequency inverter is released, a faulty signal is recognized for longer than the timeout, a fault switch-off is affected. If the parameter *Operation Mode 760* is set to zero, the monitoring function is deactivated.

<i>Operation Mode 760</i>	Function
0 - Off	The function is deactivated.
2 - Error	A fault message is displayed according to the timeouts set.

The speed sensor monitoring is to be parameterized in the sub functions according to the application. The monitoring function becomes active with the release of the frequency inverter and the start command. The timeout defines a monitoring time in which the condition for the

fault switch-off must be fulfilled without interruption. If one of the timeouts is set to zero, this monitoring function is deactivated.

Parameter		Settings		
No.	Description	Min.	Max.	Default
761	Timeout: Signal Fault	0 ms	65000 ms	1000 ms
762	Timeout: Channel fault	0 ms	65000 ms	1000 ms
763	Timeout: Direction fault	0 ms	65000 ms	1000 ms

Timeout: Signal Fault

The actual speed measured is compared with the output value of the speed controller. If the actual speed value is exactly zero for the time selected with the parameter *Timeout: Signal fault* **761**, although a reference value is available, the fault is displayed with the message "F1430".

Timeout: Channel fault

The actual speed measurement monitors the sequence in time of the signals in the quadruple evaluation of the speed sensor operation mode. If the speed sensor signal is faulty for the time selected with the parameter *Timeout: Channel fault* **762**, the fault is displayed with the message "F1431".

Timeout: Direction fault

The actual speed measured is compared with the reference speed. If the sign between reference value and actual value differs for the time selected with the parameter *Timeout: Direction fault* **763**, the fault is displayed with the message "F1432". The monitoring function is reset when the drive mechanism has moved in the reference value direction by a quarter of a revolution.

19.8 Start Monitoring

To monitor the correct starting of a drive, the Start monitoring function can be used. Especially for sluggish loads (in example applied brakes or sluggish gear boxes) the Start monitoring function a process fault is detected. The Start Monitoring function is available in configurations 2xx and 5xx.

If the parameter *Operation Mode* **693** is set to "2-Error, in configuration 2xx the encoder specified via *Actual Speed Source* **766** is monitored. In configuration 5xx the connected Resolver is monitored.

The Start monitoring function checks if the drive is operated at the current or torque limit. If the drive is operated at the current or torque limit, in a 32 ms interval it is checked, that the drive has rotated for at least 1/128 revolution (=2.81°). If a blocking drive is detected for the specified *Timeout* **694** time, the drive is switched off with fault "F0405 Start Monitoring".

<i>Operation Mode</i> 693	Function
0 - Off	The function is deactivated.
2 - Error	A fault message is displayed according to the timeouts set.

Parameter		Settings		
No.	Description	Min.	Max.	Default
694	Timeout	100 ms	65000 ms	1000 ms

20 Actual Values

The various control functions and methods include electrical control variables and various calculated actual values of the machine or system. The different actual values can be read out for operational and error diagnosis via a communication interface or in the VAL menu branch of the operating unit.

20.1 Actual Values of the Frequency Inverter

The modular hardware of the frequency inverter enables application-specific adaptation. Further actual value parameters can be displayed as a function of the selected configuration and the installed expansion cards.

Actual Values of the Frequency Inverter		
No.	Description	Function
222	DC link voltage	Direct voltage in the DC link.
223	Modulation	Output voltage of the frequency inverter relative to the mains voltage (100% = U_{FIN}).
228	Internal Reference Frequency	Sum of the Reference Frequency Sources 475 as a reference value from the frequency reference value channel.
229	Reference Percentage Value	Sum of the <i>Reference Percentage Sources</i> 476 as a reference value from the reference percentage channel.
230	Actual Percentage Value	Actual value signal on the <i>Actual Percentage Source</i> 478 .
243	Digital Inputs (Hardware)	Decimally coded status of the six digital inputs and of multifunctional input 1 in <i>Operation Mode</i> 452 - digital input. Displays the status of the physical inputs (See also <i>Digital Inputs</i> 250).
244	Working Hours Counter	Operating hours in which the output stage of the inverter is active.
245	Operation Hours Counter	Operating hours of the frequency inverter in which supply voltage is available.
249	Active data set	The data set actively in use according to <i>Data Set Change-Over 1</i> 70 and <i>Data Set Change-Over 2</i> 71 .
250	Digital Inputs	Decimally coded status of the six digital inputs and of multifunctional input 1 in <i>Operation Mode</i> 452 - digital input. Depending on the setting of parameter <i>Local/Remote</i> 412 the hardware signals or Fieldbus/Systembus signals are displayed (See also <i>Digital Inputs(Hardware)</i> 243)
251	Analog Input MFI1A	Input signal on multifunctional input 1 in <i>Operation Mode</i> 452 - analog input.
252	Repetition frequency input	Signal on repetition frequency input according to <i>Operation Mode</i> 496 .
254	Digital Outputs	Decimally coded status of the two digital outputs and of multifunctional output 1 in <i>Operation Mode</i> 550 – digital.
255	Heat Sink Temperature	Measured heat sink temperature.
256	Inside Temperature	Measured inside temperature.
257	Analog Output MFO1A	Output signal on multifunctional output 1 in <i>Operation Mode</i> 550 – analog.
259	Current Error	Error message with error code and abbreviation.
269	Warnings	Warning message with error code and abbreviation.
275	Controller Status	The reference value signal is limited by the controller coded in the controller status.
278	Repetition frequency output MFO1F	Output signal on multifunctional input 1 in <i>Operation Mode</i> 550 – repetition frequency.



The actual values can be read out and monitored in the VAL menu branch of the operating unit. The parameter *Control Level* **28** in the PARA menu branch defines the selection of the actual value parameters.



The digital inputs may seem deactivated in the actual value display **243, 250** (constant "0"). This can be caused by the used configuration or used functions (in example encoder or frequency input).

Input	Deactivation mechanism for Actual value display
S2IND	PWM / Rep. freq. input
S4IND	Spur B (Encoder 1)
S5IND	Spur A (Encoder 1)
S6IND	Spur Z (Encoder 1) or PWM / Rep. freq. input
MFI1	Analogue-input

Settings:

For Encoder 1, check Parameter *Operation mode* **490**.

For PWM / Rep. Freq. input, check Parameter *Operation mode* **496**.

For MFI1 check Parameter *Operation mode* **452**.

Actual value:

Encoder 1: Frequency is displayed in **217**, speed in **218**.

PWM / Rep. freq. input: PWM is displayed in **258**, frequency in **252**.

20.2 Actual Values of the Machine

The frequency inverter controls the behavior of the machine in the various operating points. As a function of the configuration selected and the expansion cards installed, control variables and further actual value parameters of the machine can be displayed.

Actual Values of the Machine		
No.	Description	Function
210	Stator Frequency	The output frequency (motor frequency) of the frequency inverter.
211	R.m.s Current	Calculated effective output current (motor current) of the frequency inverter.
212	Output Voltage	Calculated RMS figure of the phase-to-phase voltage (motor voltage) of the frequency inverter
213	Active Power	Active power calculated from the voltage, the current and the control variables.
214	Active Current	Active current calculated from the rated motor parameters, the control variables and the current
215	Isd	Current component of the field-orientated control forming the magnetic flux.
216	Isq	Torque-forming current component of field-orientated control.
217	Encoder 1 Frequency	Calculated from the data on encoder 1, the <i>No. of Pole Pairs</i> 373 and the encoder signal.
218	Encoder 1 Speed	Calculation from encoder 1 frequency.
221	Slip Frequency	Difference from the synchronous frequency calculated from the rated motor parameters, the control variables and the current.
224	Torque	Torque at the current output frequency calculated from the voltage, the current and the control variables.
225	Rotor Flux	Current magnetic flux relative to the rated motor parameters.
226	Winding Temperature	Measured temperature of the motor winding according to <i>Operation Mode</i> 465 for temperature adjustment.
227	Act. Rotor Time Constant	Time constant calculated for the operating point of the machine from the rated motor parameters, the rated and control variables.
235	Flux-Forming Voltage	Voltage component of the field-orientated control forming the magnetic flux.
236	Torque-Forming Voltage	Voltage component of the field-orientated control forming the torque.

238	Flux Value	Magnetic flux calculated according to the rated values and the operating point of the motor.
239	Reactive Current	Reactive current calculated from the rated motor parameters, the control variables and the current
240	Actual Speed	Measured and/or calculated speed of drive.
241	Actual Frequency	Measured and/or calculated frequency of drive.



The actual values can be read out and monitored in the VAL menu branch of the operating unit. The parameter *Control Level* **28** in the PARA menu branch defines the selection of the actual value parameters to be selected.

20.3 Actual Value Memory

The assessment of the operating behavior and the maintenance of the frequency inverter in the application is facilitated by storing various actual values. The actual value memory guarantees monitoring of the individual variables for a definable period. The parameters of the actual value memory can be read out via a communication interface and displayed via the operating unit. In addition, the operating unit provides monitoring of the peak and mean values in the VAL menu branch.

Actual value memory		
No.	Description	Function
231	Peak Value Long Term Ixt	Utilization of the device-dependent overload of 60 seconds.
232	Peak Value, Short Term Ixt	Utilization of the device-dependent overload of 1 second.
287	Peak Value Vdc	The maximum DC link voltage measured.
288	Average Value Vdc	The average DC link voltage calculated in the period of observation.
289	Peak Value Heat Sink Temp.	The highest measured heat sink temperature of the frequency inverter.
290	Average Value Heat Sink Temp.	The average heat sink temperature calculated in the period of observation.
291	Peak Value Inside Temperature	The maximum measured inside temperature in the frequency inverter.
292	Average Value Inside Temperature	The average inside temperature calculated in the period of observation.
293	Peak value Irms	The highest absolute current calculated from the measured motor phases.
294	Average value Irms	The average absolute current calculated in the period of observation.
295	Peak Value Active Power pos.	The largest calculated active power in motor operation.
296	Peak Value Active Power neg.	Maximum generator active power calculated from the voltage, the current and the control variables.
297	Average Value Active Power	The average active power calculated in the period of observation.
301	Energy, positive	The calculated energy to the motor in motor operation.
302	Energy, negative	The calculated energy from the motor in generator operation.



The actual values can be read out and monitored in the VAL menu branch of the operating unit. The parameter *Control Level* **28** in the PARA menu branch defines the selection of the actual value parameters to be selected.

The *Reset Memory* **237** parameter to be selected in the PARA menu branch of the operating unit enables purposeful resetting of the individual average and peak values. The peak value and the average value with the values stored in the period are overwritten with the parameter value zero.

Operation mode	Function
0 - No deleting	Values of actual value memory remain unchanged.
1 - Peak Value Long Term Ixt	Reset <i>Peak Value Long-Term Ixt</i> 231 .
2 - Peak Value Short Term Ixt	Reset <i>Peak Value Short-Term Ixt</i> 232 .
3 - Peak Value Vdc	Reset <i>Peak Value Vdc</i> 287 .
4 - Average Value Vdc	Delete <i>Average Value Vdc</i> 288 .
5 - Peak Value Tc	Reset <i>Peak Value Heat Sink Temp.</i> 289 .
6 - Average Value Tc	Delete <i>Average Value Heat Sink Temp.</i> 290 .
7 - Peak Value Ti	Reset <i>Peak Value Inside Temperature</i> 291 .
8 - Average Value Ti	Delete <i>Average Value Inside Temperature</i> 292 .
9 - Peak value Irms	Reset <i>Peak Value Irms</i> 293 .
10 - Average value Irms	Delete <i>Average Value Irms</i> 294 .
11 - Peak Value Pactive pos.	Reset <i>Peak Value Active Power pos.</i> 295 .
12 - Peak Value Pactive neg.	Reset <i>Peak Value Active Power neg.</i> 296 .
13 - Average Value Pactive	Delete <i>Average Value Active Power</i> 297 .
16 - Energy, positive	Reset parameter <i>Energy, positive</i> 301 .
17 - Energy, negative	Reset parameter <i>Energy, negative</i> 302 .
100 - All Peak Values	Reset all peak values stored.
101 - All Average Values	Delete average values and stored values.
102 - All Values	Delete the entire actual value memory.

20.4 Actual Values of the System

The calculation of the actual values of the system is based on the parameterized system data. Specific to the application, the parameters are calculated from the factors, electrical variables, and the controls. The correct display of the actual values is a function of the data of the system to be parameterized.

20.4.1 Actual Value System

The drive can be monitored via the actual value *Actual Value System* **242**.

The *Actual Frequency* **241** to be monitored is multiplied by the Factor *Actual Value System* **389** and can be read out via the parameter *Actual Value System* **242**, i.e. *Actual Frequency* **241** x Factor *Actual Value System* **389** = *Actual Value System* **242**.

Actual Value System		
No.	Description	Function
242	Actual Value System	Calculated frequency of drive

20.4.2 Volume Flow and Pressure

The parameterization of the factors *Nominal Volumetric Flow* **397** and *Nominal Pressure* **398** is necessary if the matching actual values *Volumetric flow* **285** and *Pressure* **286** are used to monitor the drive. The conversion is done using the electrical control parameters. *Volume Flow* **285** and *Pressure* **286** are referred to the *Effective Current* **214** in the case of the sensor-less control methods. In the case of the field-oriented control methods, they are referred to the torque-forming current component *Isq* **216**.

Volume Flow and Pressure		
No.	Description	Function
285	Volumetric Flow	Calculated volume flow with the unit m ³ /h
286	Pressure	Pressure calculated according to the characteristic with the unit kPa

21 Error Protocol

The various control methods and the hardware of the frequency inverter include functions which continuously monitor the application. The operational and error diagnosis is facilitated by the information stored in the error protocol.

21.1 Error List

The last 16 fault messages are stored in chronological order and the *No. of Errors* **362** shows the number of errors which have occurred since commissioning of the frequency inverter. In the VAL menu branch of the control unit, the error code FXXXX is displayed. The meaning of the error key is described in the following chapter "Error Messages". Via the PC program, the number of operation hours (h), operation minutes (m) and the fault message can additionally be read out. The current operating hours can be read out via the *Operation Hours Counter* **245**. The fault report can be acknowledged via the keys of the operating unit and according to the assignment *Error Acknowledgment* **103**.

Error List		
No.	Description	Function
310	Last Error	hhhhh:mm ; FXXXX fault message.
311	Last Error but one	hhhhh:mm ; FXXXX fault message.
312 to 325		Error 3 to error 16.
362	No. of errors occurred	Number of errors occurred after commissioning of the frequency inverter.

The error and warning behavior of the frequency inverter can be set in various ways. The automatic error acknowledgment enables acknowledgment of the faults Overcurrent F0500, Overcurrent F0507 and Overvoltage F0700 without intervention by an overriding control system or the user. The *No. of self acknowledged Errors* **363** shows the total number of automatic error acknowledgments.

Error List		
No.	Description	Function
363	No. of acknowledgment Errors	Total number of automatic error acknowledgment with synchronization.

21.1.1 Error Messages

The error code stored following a fault comprises the error group FXX and the following code number XX.

Error Messages		
Code		Meaning
F00	00	No fault has occurred.
Overload		
F01	00	Frequency inverter overloaded.
F01	02	Frequency inverter overloaded (60 s), check load behavior.
	03	Short-term overload (1 s), check motor and application parameters.
Heat Sink		
F02	00	Heat sink temperature too high, check cooling and fan.
	01	Temperature sensor defective or ambient temperature too low.

Table "Error Messages" continued on next page.

Inside		
Code		Meaning
F03	00	Inside temperature too high, check cooling and fan.
	01	Inside temperature too low, check electrical cabinet heating.
Motor Connection		
F04	00	Motor temperature too high or sensor defective, check connection S6IND.
	01	Motor circuit breaker tripped, check drive.
	02	V-belt monitoring reports no load on the drive.
	03	Phase failure, check motor and wiring.
Output current		
F05	00	Overloaded, check load situation and ramps.
	03	Short circuit or earth fault, check motor and wiring.
	04	Overloaded, check load situation and current value limit controller.
	05	Asymmetric motor current, check current and wiring.
	06	Motor phase current too high, check motor and wiring.
	07	Message from phase monitoring, check motor and wiring.
DC link voltage		
F07	00	DC link voltage too high, check deceleration ramps and connected brake resistor.
	01	DC link voltage too low, check mains voltage.
	02	Power failure, check mains voltage and circuit.
	03	Phase failure, check mains fuses and circuit.
	04	Reference DC-Link Limitation 680 too low, check mains voltage.
	05	Brake chopper Trigger Threshold 506 too low, check mains voltage.
	06	Motor chopper Trigger Threshold 507 too low, check mains voltage.
Electronics voltage		
F08	01	Electronics voltage 24 V too low, check control terminal.
	04	Electronics voltage too high, check wiring of control terminals.
Output frequency		
F11	00	Output frequency too high, check control signals and settings.
	01	Max. frequency reached by control, check deceleration ramps and connected brake resistor.
Motor Connection		
F13	00	Earth fault on output, check motor and wiring.
	01	Set <i>IDC-Compensation Limit</i> 415 reached, check motor and cabling, increase limit, if necessary.
	10	Minimum current monitoring, check motor and wiring.
Control Connection		
F14	01	Reference value on multifunctional input 1 faulty, check signal.
	07	Overcurrent on multifunctional input 1, check signal.
	30	Speed sensors signal defective, check connections S4IND and S5IND.
	31	One track of the speed sensor signal is missing, check connections.
	32	Direction of rotation of speed sensor wrong, check connections.
Optional Components		
F0A	10	Data transmission from control unit KP 500 to inverter failed. In the control unit must be stored at least 1 file.
F0B	13	The communication module was fitted to slot B without disconnection of the mains voltage, switch mains voltage off.

In addition to fault messages mentioned, there are further fault messages. However, these messages are only used for internal purposes and are not listed here. If you receive fault messages which are not listed here, please contact us by phone.

21.2 Error Environment

The parameters of the error environment help troubleshooting both in the settings of the frequency inverter and also in the complete application. The error environment documents the operational behavior of the frequency inverter at the time of the last four faults.

Error Environment		
No.	Description	Function
330	DC link voltage	Direct voltage in the DC link.
331	output voltage	Calculated output voltage (motor voltage) of the frequency inverter.
332	Stator Frequency	The output frequency (motor frequency) of the frequency inverter.
333	Encoder 1 Frequency	Calculated from the data on encoder 1, the <i>No. of Pole Pairs</i> 373 and the encoder signal.
335	Phase Current Ia	Measured current in motor phase U.
336	Phase Current Ib	Measured current in motor phase V.
337	Phase Current Ic	Measured current in motor phase W.
338	R.m.s Current	Calculated effective output current (motor current) of the frequency inverter.
339	Isd / Reactive Current	Current component forming the magnetic flux or the calculated reactive current.
340	Isq / Active Current	Current component forming the torque or the calculated active current.
341	Rotor Magnetizing Current	Magnetizing current relative to the rated motor parameters and the operating point.
342	Torque	Torque calculated from the voltage, the current and the control variables.
343	Analog Input MF11A	Input signal on multifunctional input 1 in <i>Operation Mode</i> 452 - analog input.
346	Analog Output MFO1A	Output signal on multifunctional output 1 in <i>Operation Mode</i> 550 - analog.
349	Repetition Frequency Output	Signal at repetition frequency output according to <i>Operation Mode</i> 550 - repetition frequency.
350	Status of Digital Inputs	Decimally coded status of the six digital inputs and of multifunctional input 1 in <i>Operation Mode</i> 452 - digital input.
351	Status of Digital Outputs	Decimally coded status of the two digital outputs and of multifunctional output 1 in <i>Operation Mode</i> 550 - digital.
352	Time since Release	The time of the error in hours (h), minutes (m) and seconds (s) after the release signal: hhhhh:mm:ss . ^{sec/10} ^{sec/100} ^{sec/1000} .
353	Heat Sink Temperature	Measured heat sink temperature.
354	Inside Temperature	Measured inside temperature.
355	Controller Status	The reference value signal is limited by the controller coded in the controller status.
356	Warning Status	The warning messages coded in warning status.
Error Environment		
357	Int. Value 1	Software service parameter.
358	Int. Value 2	Software service parameter.
359	Long Value 1	Software service parameter.
360	Long Value 2	Software service parameter.

The *Checksum* **361** parameter shows whether the storage of the error environment was free of errors (OK) or incomplete (NOK).

Error Environment

No.	Description	Function
361	Checksum	Check protocol of the error environment.

22 Operational and Error Diagnosis

Operation of the frequency inverter and the connected load are monitored continuously. Various functions document the operational behavior and facilitate the operational and error diagnosis.

22.1 Status Display

The green and red light-emitting diodes give information about the operating point of the frequency inverter. If the control unit is connected, the status messages are additionally displayed by the display elements RUN, WARN and FAULT.

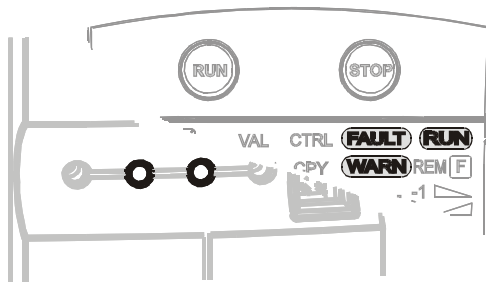

Status Display

green LED	red LED	Display	Description
off	off	-	No supply voltage.
on	on	-	Initialization and self-test.
flashes	off	RUN flashes	Ready for operation, no output signal.
on	off	RUN	Operating message.
on	flashes	RUN flashes + WARN flashes	Operational message, current <i>Warning 269</i> .
flashes	flashes	RUN flashes + WARN flashes	Ready for operation, current <i>Warning 269</i> .
off	flashes	FAULT flashes	<i>Last Error 310</i> of frequency inverter.
off	on	FAULT	<i>Last Error 310</i> , acknowledge fault.

22.2 Status of Digital Signals

The status display of the digital input and output signals enables checking of the various control signals and their assignment to the corresponding software functions, in particular during commissioning.

Coding of the status of the digital signals

Assignment:

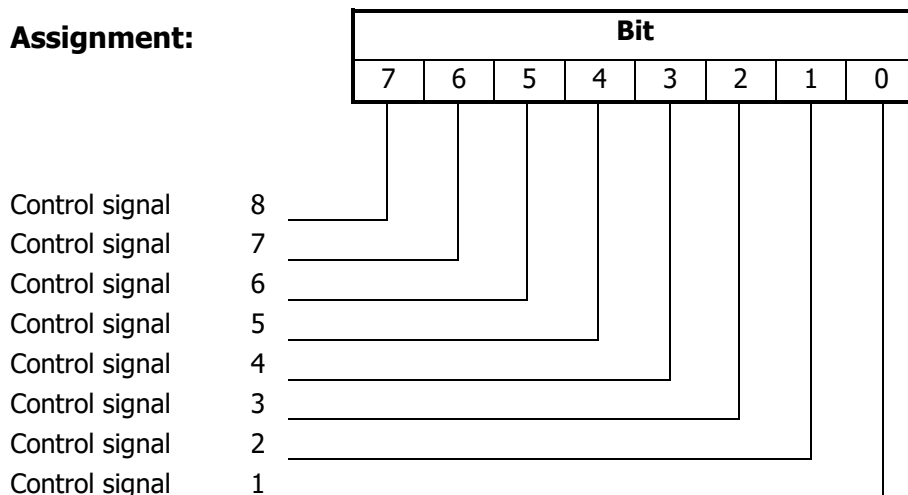

A decimal value is displayed, indicating the status of the digital signals in bits after conversion into a binary figure.

Example: Decimal figure 33 is displayed. Converted into the binary system, the number reads **00100001**. Thus, the following contact inputs or outputs are active:

- Control signal at digital input or output 1
- Control signal at digital input or output 6

22.3 Controller Status

The controller status can be used to establish which of the control functions are active. If several controllers are active at the time, a controller code composed of the sum total of the individual codes is displayed. The display of the controller status by the control unit and the light-emitting diodes can be parameterized via the *Controller -Status Message* **409**.

Coding of the controller status				
		CXXXX		
			ABCDE	
		Controller code	Controller abbreviation	
Code			Controller Status	
C	00	00	-	No controller active
C	00	01	UDdyn	Voltage controller is in the rise phase according to <i>Operation Mode</i> 670 .
C	00	02	UDstop	The output frequency in the case of a mains failure is below the <i>Shutdown Threshold</i> 675 .
C	00	04	UDctr	Failure of the mains voltage and power regulation active according to <i>Operation Mode</i> 670 of the voltage controller.
C	00	08	UDlim	The DC link voltage has exceeded the <i>Reference DC-Link Limitation</i> 680 .
C	00	10	Boost	The <i>Dyn. Voltage Pre-Control</i> 605 accelerates the control behavior.
C	00	20	Ilim	The output current is limited by the current limit value controller or the speed controller.
C	00	40	Tlim	The output power or the torque are limited on the speed controller.
C	00	80	Tctr	Switch-over of field-orientated control between speed and torque-controlled control method.
C	01	00	Rstp	The <i>Operation Mode</i> 620 selected in starting behavior limits the output current.
C	02	00	IxtLtLim	Overload limit of the long-term Ixt (60s) reached, intelligent current limits active.
C	04	00	IxtStLim	Overload limit of the short-term Ixt (1s) reached, intelligent current limits active.
C	08	00	Tclim	Max. heat sink temperature TK reached, intelligent current limits of <i>Operation Mode</i> 573 active.
C	10	00	PTClim	Max. motor temperature reached, intelligent current limits of <i>Operation Mode</i> 573 active.
C	20	00	Flim	The reference frequency has reached the <i>Maximum Frequency</i> 419 . The frequency limitation is active.

Example: The controller status is displayed

C0024 UDctr Ilim

The controller status results from the hexadecimal sum of the controller codes (0004+0020 = 0024).

At the same, the power failure regulation and also the current limitation of the speed controller are active.

22.4 Warning Status

The current warning is displayed by a message in the warning status and can be used for an early message of a critical operational condition. If a warning is present, this is indicated by the flashing red LED and the display field WARN of the control unit. If several warnings are present, the warning status is displayed as the sum of the individual warning codes.

The warning mask created through parameters *Create warning mask* **536** has no influence on the warnings displayed. Via the actual value parameters *Warning* **269** and *Warning status* **356** (in error environment) all warnings present at the time of the error are always displayed.

Coding of the warning status

AXXXX	ABCDE
Warning code	Abbreviation for the warning

Code	Warning Status
A 00 00 -	No warning message present.
A 00 01 Ixt	Frequency inverter overloaded (A0002 or A0004).
A 00 02 IxtSt	Overload for 60 s relative to the nominal output of the frequency inverter.
A 00 04 IxtLt	Short-time overload for 1 s relative to the nominal output of the frequency inverter.
A 00 08 Tc	Max. heat sink temperature T_K of 80 °C less the <i>Warning Limit Heat Sink Temp</i> 407 reached.
A 00 10 Ti	Max. inside temperature T_i of 65 °C less the <i>Warning Limit Inside Temp.</i> 408 reached.
A 00 20 Lim	The controller stated in <i>Controller Status</i> 275 limits the reference value.
A 00 40 INIT	Frequency inverter is initialized.
A 00 80 PTC	Warning behavior according to parameterized <i>Motor Temp. Operation Mode</i> 570 at max. motor temperature T_{Motor} .
A 01 00 Mains	<i>Phase Supervision</i> 576 reports a phase failure.
A 02 00 PMS	Motor circuit breaker parameterized in <i>Operation Mode</i> 571 tripped.
A 04 00 Flim	The <i>Maximum Frequency</i> 419 was exceeded. The frequency limitation is active.
A 08 00 A1	The input signal MFI1A is lower than 1 V / 2 mA according to the operation mode for the <i>Error/Warning Behavior</i> 453 .
A 10 00 A2	The input signal is lower than 1 V / 2 mA according to the operation mode for the <i>Error/Warning Behavior</i> 453 .
A 20 00 SYS	A Slave at the system bus signals a fault; Warning is only relevant with option EM-SYS.
A 40 00 UDC	The DC link voltage has reached the type-dependent minimum value.
A 80 00 BELT	The <i>Operation Mode</i> 581 for V-belt monitoring signals no-load operation of the application.

Example: The warning status is displayed.



A008D Ixt IxtLt Tc PTC

The warning status results from the hexadecimal sum of the warning codes (0001+0004+0008+0080 = 008D).

The short-term overload (1 s), warning limit heat sink temperature and warning limit motor temperature warnings are present.

23 Parameter List

The parameter list is structured according to the menu branches of the control unit. The parameters are listed in ascending numerical order. A headline (shaded) can appear several times, i.e. a subject area may be listed at different places in the table. For better clarity, the parameters have been marked with pictograms:

-  The parameter is available in the four data sets.
- The parameter value is set by the SETUP routine.
-  This parameter cannot be written when the frequency inverter is in operation.

I_{FIN} , U_{FIN} , P_{FIN} : rated values of the frequency inverter, o : overload capacity of frequency inverter

23.1 Actual Value Menu (VAL)

Actual Values of the Machine				
No.	Description	Unit	Display range	Chapter
210	Stator Frequency	Hz	0.00 ... 599.00	20.2
211	RMS Current	A	0.0 ... I_{max}	20.2
212	Output Voltage	V	0.0 ... U_{FIN}	20.2
213	Active Power	kW	0.0 ... P_{max}	20.2
214	Active Current	A	0.0 ... I_{max}	20.2
215	Isd	A	0.0 ... I_{max}	20.2
216	Isq	A	0.0 ... I_{max}	20.2
217	Encoder 1 Frequency	Hz	0.00 ... 599.00	11.4
218	Encoder 1 Speed	1/min	0 ... 60000	11.4
221	Slip Frequency	Hz	0.0 ... 599.00	20.2
Actual Values of the Frequency Inverter				
222	DC link voltage	V	0.0 ... $U_{dmax}-25$	20.1
223	Modulation	%	0 ... 100	20.1
Actual Values of the Machine				
224	Torque	Nm	± 9999.9	20.2
225	Rotor Flux	%	0 ... 100	20.2
226	Winding Temperature	deg. C	0 ... 999	19.7.2
227	Act. Rotor Time Constant	ms	0 ... τ_{max}	20.2
Actual Values of the Frequency Inverter				
228	Internal Reference Frequency	Hz	0.00 ... f_{max}	20.1
229	Reference Percentage Value	%	± 300.00	20.1
230	Actual Percentage Value	%	± 300.00	20.1
Actual value memory				
231	Peak Value Long Term Ixt	%	0.00 ... 100.00	20.3
232	Peak Value Short Term Ixt	%	0.00 ... 100.00	20.3
Actual Values of the Machine				
235	Flux-Forming Voltage	V	0.0 ... U_{FIN}	20.2
236	Torque-Forming Voltage	V	0.0 ... U_{FIN}	20.2
238	Flux Value	%	0.0 ... 100.0	20.2
239	Reactive Current	A	0.0 ... I_{max}	20.2
240	Actual Speed	1/min	0 ... 60000	20.2
241	Actual Frequency	Hz	0.0 ... 599.00	20.2
Actual Values of the System				
242	Actual Value System	Hz	0.0 ... 599.00	20.4.1

Actual Values of the Frequency Inverter

No.	Description	Unit	Display range	Chapter
243	Digital Inputs (Hardware)	-	00 ... 255	22.2
244	Working Hours Counter	h	99999	20.1
245	Operation Hours Counter	h	99999	20.1
249	Active Data Set	-	1 ... 4	16.4.6
250	Digital Inputs	-	00 ... 255	22.2
251	Analog Input MFI1A	%	± 100.00	16.1.1
252	Repetition frequency input	Hz	0.0 ... 599.00	15.11
254	Digital Outputs	-	00 ... 255	22.2
255	Heat Sink Temperature	deg.C	0 ... T _{kmax}	20.1
256	Inside Temperature	deg.C	0 ... T _{imax}	20.1
257	Analog Output MFO1A	V	0.0 ... 24.0	16.2.1
259	Current Error	-	FXXXX	20.1
269	Warnings	-	AXXXX	20.1
275	Controller Status	-	CXXXX	20.1
278	Frequency MFO1F	Hz	0.00 ... f _{max}	16.2.2

Actual Values of the System

285	Volumetric Flow	m ³ /h	0 ... 99999	20.4.2
286	Pressure	kPa	0.0 ... 999.9	20.4.2

Actual value memory

287	Peak Value Vdc	V	0.0 ... U _{dmax}	20.3
288	Average Value Vdc	V	0.0 ... U _{dmax}	20.3
289	Peak Value Heat Sink Temp.	deg.C	0 ... T _{kmax}	20.3
290	Average Value Heat Sink Temp.	deg.C	0 ... T _{kmax}	20.3
291	Peak Value Inside Temperature	deg.C	0 ... T _{imax}	20.3
292	Average Value Inside Temperature	deg.C	0 ... T _{imax}	20.3
293	Peak value Irms	A	0.0 ... o · I _{FIN}	20.3
294	Average value Irms	A	0.0 ... o · I _{FIN}	20.3
295	Peak Value Active Power pos.	kW	0.0 ... o · P _{FIN}	20.3
296	Peak Value Active Power neg.	kW	0.0 ... o · P _{FIN}	20.3
297	Average Value Active Power	kW	0.0 ... o · P _{FIN}	20.3
301	Energy, positive	kWh	0 ... 99999	20.3
302	Energy, negative	kWh	0 ... 99999	20.3

Error List



























310	Last Error	h:m; F	00000:00; FXXXX	21.1
311	Last Error but one	h:m; F	00000:00; FXXXX	21.1
312	Error 3	h:m; F	00000:00; FXXXX	21.1
313	Error 4	h:m; F	00000:00; FXXXX	21.1
314	Error 5	h:m; F	00000:00; FXXXX	21.1
315	Error 6	h:m; F	00000:00; FXXXX	21.1
316	Error 7	h:m; F	00000:00; FXXXX	21.1
317	Error 8	h:m; F	00000:00; FXXXX	21.1
318	Error 9	h:m; F	00000:00; FXXXX	21.1
319	Error 10	h:m; F	00000:00; FXXXX	21.1
320	Error 11	h:m; F	00000:00; FXXXX	21.1
321	Error 12	h:m; F	00000:00; FXXXX	21.1
322	Error 13	h:m; F	00000:00; FXXXX	21.1
323	Error 14	h:m; F	00000:00; FXXXX	21.1
324	Error 15	h:m; F	00000:00; FXXXX	21.1
325	Error 16	h:m; F	00000:00; FXXXX	21.1

Error Environment				
No.	Description	Unit	Display range	Chapter
330	DC link voltage	V	0.0 ... U_{dmax}	21.2
331	output voltage	V	0.0 ... U_{FIN}	21.2
332	Stator Frequency	Hz	0.00 ... 599.00	21.2
333	Encoder 1 Frequency	Hz	0.00 ... 599.00	21.2
335	Phase Current Ia	A	0.0 ... I_{max}	21.2
336	Phase Current Ib	A	0.0 ... I_{max}	21.2
337	Phase Current Ic	A	0.0 ... I_{max}	21.2
338	RMS Current	A	0.0 ... I_{max}	21.2
339	Isd / Reactive Current	A	0.0 ... I_{max}	21.2
340	Isq / Active Current	A	0.0 ... I_{max}	21.2
341	Rotor Magnetizing Current	A	0.0 ... I_{max}	21.2
342	Torque	Nm	± 9999.9	21.2
343	Analog Input MFI1A	%	± 100.00	21.2
346	Analog Output MFO1A	V	0.0 ... 24.0	21.2
349	Repetition Frequency Output	Hz	0.00 ... 599.00	21.2
350	Status of Digital Inputs	-	00 ... 255	22.2
351	Status of Digital Outputs	-	00 ... 255	22.2
352	Time since Release	h:m:s.ms	00000:00:00.000	21.2
353	Heat Sink Temperature	deg.C	0 ... T_{kmax}	21.2
354	Inside Temperature	deg.C	0 ... T_{imax}	21.2
355	Controller Status	-	C0000 ... CFFFF	22.3
356	Warning Status	-	A0000 ... AFFFF	22.4
357	Int Value 1	-	± 32768	21.2
358	Int Value 2	-	± 32768	21.2
359	Long Value 1	-	± 2147483647	21.2
360	Long Value 2	-	± 2147483647	21.2
361	Checksum	-	OK / NOK	21.2
Error List				
362	No. of Errors	-	0 ... 32767	21.1
363	No. of self acknowledged Errors	-	0 ... 32767	21.1
Positioning				
470	Rotations	U	0.000 ... $1 \cdot 10^6$	13.6
Digital Outputs				
537	Actual Warning Mask	-	AXXXXXXXXX	16.3.7
Self-configuration				
797	SETUP Status	-	OK / NOK	9.5

23.2 Parameter Menu (PARA)

Inverter Data				
No.	Description	Unit	Setting range	Chapter
0	Serial Number	-	Characters	10.1
1	Optional Modules	-	Characters	10.2
12	Inverter Software Version	-	Characters	10.3
27	Set Password	-	0 ... 999	10.4
28	Control Level	-	1 ... 3	10.5
29	User Name	-	32 characters	10.6
⊗ 30	Configuration	-	Selection	10.7
33	Language	-	Selection	10.8
⊗ 34	Program(ming)	-	0 ... 9999	10.9
37	Start Positioning of Axle	-	Selection	13.6.2
Fan				
39	Switch-On Temperature	deg.C	0 ... 60	19.2
Digital Inputs				
62	Frequency Motorpoti Up	-	Selection	16.4.8
63	Frequency Motorpoti Down	-	Selection	16.4.8
66	Fixed Frequency Change-Over 1	-	Selection	16.4.7
67	Fixed Frequency Change-Over 2	-	Selection	16.4.7
68	Start Clockwise	-	Selection	16.4.1
69	Start Anticlockwise	-	Selection	16.4.1
70	Data set change-over 1	-	Selection	16.4.6
71	Data set change-over 2	-	Selection	16.4.6
72	Percent Motorpoti Up	-	Selection	16.4.8
73	Percent Motorpoti Down	-	Selection	16.4.8
75	Fixed percentage value change-over 1	-	Selection	16.4.7
76	Fixed percentage value change-over 2	-	Selection	16.4.7
83	Timer 1	-	Selection	16.4.3
84	Timer 2	-	Selection	16.4.3
87	Start 3-wire-control	-	Selection	16.4.2
103	Error Acknowledgment	-	Selection	16.4.2
164	n-/M-Control Change-Over	-	Selection	16.4.5
Logic Modules				
198	Operation mode Logic 1	-	Selection	16.5.3
199	Input 1 Logic 1	-	Selection	16.5.3
200	Input 2 Logic 1	-	Selection	16.5.3
201	Operation mode Logic 2	-	Selection	16.5.3
202	Input 1 Logic 2	-	Selection	16.5.3
203	Input 2 Logic 2	-	Selection	16.5.3
Digital Inputs				
204	Therm. Contact	-	Selection	16.4.4
Logic Modules				
205	Operation mode Logic 3	-	Selection	16.5.3
206	Input 1 Logic 3	-	Selection	16.5.3
207	Input 2 Logic 3	-	Selection	16.5.3
Actual value memory				
237	Reset Memory	-	Selection	20.3

































Controlled commissioning







































No.	Description	Unit	Setting range	Chapter			
369	Motor Type	-	Selection	9.2.3			
Rated Motor Parameters							
	370	Rated Voltage	V	$0.17 \cdot U_{FIN} \dots 2 \cdot U_{FIN}$	11.1		
	371	Rated Current	A	$0.01 \cdot I_{FIN} \dots 10 \cdot I_{FIN}$	11.1		
	372	Rated Speed	U/min	96 ... 60000	11.1		
<input checked="" type="checkbox"/>		373	No. of Pole Pairs	-	1 ... 24	11.1	
	374	Rated Cosinus Phi	-	0.01 ... 1.00	11.1		
	375	Rated Frequency	Hz	10.00 ... 1000.00	11.1		
	376	Rated Mech. Power	kW	$0.1 \cdot P_{FIN} \dots 10 \cdot P_{FIN}$	11.1		
Further motor parameters							
<input checked="" type="checkbox"/>		377	Stator Resistance	mOhm	0 ... 65535	11.2	
<input checked="" type="checkbox"/>		378	Leakage Coeff.	%	1.0 ... 20.0	11.2	
System data							
	389	Factor Actual Value System	-	-100.000 ... 100.000	12.1		
	397	Nominal Volumetric Flow	m ³ /h	1 ... 99999	12.2		
	398	Nominal Pressure	kPa	0.1 ... 999.9	12.2		
Pulse Width Modulation							
	400	Switching frequency	-	Selection	19.1		
	401	Min. Switching Frequency	-	Selection	19.1		
Error/warning behavior							
	405	Warning Limit Short Term Ixt	%	6 ... 100	14.1		
	406	Warning Limit Long Term Ixt	%	6 ... 100	14.1		
	407	Warning Limit Heat Sink Temp.	deg.C	-25 ... 0	14.2		
	408	Warning Limit Inside Temp.	deg.C	-25 ... 0	14.2		
	409	Controller-Status Message	-	Selection	14.3		
Bus controller							
	412	Local/Remote	-	Selection	19.3		
Error/warning behavior							
	415	IDC Compensation Limit	V	0.0 ... 1.5	14.4		
	417	Frequency Switch-Off Limit	Hz	0.00 ... 599.00	14.5		
Frequency Limits							
<input checked="" type="checkbox"/>			418	Minimum Frequency	Hz	0.00 ... 599.00	15.1
<input checked="" type="checkbox"/>			419	Maximum Frequency	Hz	0.00 ... 599.00	15.1
Frequency ramps							
	420	Acceleration (Clockwise)	Hz/s	0.00 ... 9999.99	15.7		
	421	Deceleration (Clockwise)	Hz/s	0.01 ... 9999.99	15.7		
	422	Acceleration Anticlockwise	Hz/s	-0.01 ... 9999.99	15.7		
	423	Deceleration Anticlockwise	Hz/s	-0.01 ... 9999.99	15.7		
	424	Emergency Stop Clockwise	Hz/s	0.01 ... 9999.99	15.7		
	425	Emergency Stop Anticlockwise	Hz/s	0.01 ... 9999.99	15.7		
	426	Maximum Leading	Hz	0.01 ... 599.00	15.7		
	430	Ramp Rise Time Clockwise	ms	0 ... 65000	15.7		
	431	Ramp Fall Time Clockwise	ms	0 ... 65000	15.7		
	432	Ramp Rise Time Anticlockwise	ms	0 ... 65000	15.7		
	433	Ramp Rise Time Anticlockwise	ms	0 ... 65000	15.7		

































Technology Controller				
No.	Description	Unit	Setting range	Chapter
440	Operation mode	-	Selection	18.3
441	Fixed Frequency	Hz	-599.00 ... 599.00	18.3
442	max. P-Component	Hz	0.01 ... 599.00	18.3
443	Hysteresis	%	0.01 ... 100.00	18.3
444	Amplification	-	-15.00 ... 15.00	18.3
445	Integral Time	ms	0 ... 32767	18.3
446	Ind. Volume Flow Control Factor	-	0.10 ... 2.00	18.3
Block Frequencies				
447	1st Blocking Frequency	Hz	0.00 ... 599.00	15.9
448	2nd Blocking Frequency	Hz	0.00 ... 599.00	15.9
449	Frequency Hysteresis	Hz	0.00 ... 100.00	15.9
Multifunctional input 1				
450	Tolerance Band	%	0.00 ... 25.00	16.1.1.3
451	Filter Time Constant	ms	Selection	16.1.1.4
452	Operation mode	-	Selection	16.1
453	Error/Warning Behavior	-	Selection	16.1.1.5
454	Point X1	%	0.00 ... 100.00	16.1.1.1
455	Point Y1	%	-100.00 ... 100.00	16.1.1.1
456	Point X2	%	0.00 ... 100.00	16.1.1.1
457	Point Y2	%	-100.00 ... 100.00	16.1.1.1
Positioning				
458	Operation mode	-	Selection	13.6
459	Signal Source	-	Selection	13.6.1
460	Positioning Distance	U	0.000 ... 1 10 ⁶	13.6.1
461	Signal Correction	ms	-327.68 ... 327.67	13.6.1
462	Load Correction	-	-32768 ... 32767	13.6.1
463	Activity after Positioning	-	Selection	13.6.1
464	Waiting Time	ms	0 ... 3.6 10 ⁶	13.6.1
Temperature Adjustment				
465	Operation mode	-	Selection	19.7.2
466	Temperature Coefficient	%/100	0.00 ... 300.00	19.7.2
467	Adjusting Temperature	deg.C	-50.0 ... 300.0	19.7.2
Positioning				
469	Reference Orientation	°	0.0 ... 359.9	13.6.2
471	Positioning Frequency	Hz	1.00 ... 50.00	13.6.2
472	Max positional error	°	0.1 ... 90.0	13.6.2
Motor Potentiometer				
473	Ramp Keypad-Motorpoti	Hz/s	0.01 ... 999.99	15.10
474	Operation mode	-	Selection	15.10
Frequency Reference Channel				
475	Reference Frequency Source	-	Selection	15.4
Reference percentage channel				
476	Reference Percentage Source	-	Selection	15.5
Percentage ramp				
477	Gradient Percentage Ramp	%/s	0 ... 60000	15.8
Technology Controller				
478	Actual Percentage source	-	Selection	18.3
Positioning				
479	time constant positioning controller	ms	1.00 ... 9999.99	13.6.2

Fixed Frequencies				
No.	Description	Unit	Setting range	Chapter
480	Fixed Frequency 1	Hz	-599.00 ... 599.00	15.6.1
481	Fixed Frequency 2	Hz	-599.00 ... 599.00	15.6.1
482	Fixed Frequency 3	Hz	-599.00 ... 599.00	15.6.1
483	Fixed Frequency 4	Hz	-599.00 ... 599.00	15.6.1
489	JOG-Frequency	Hz	-599.00 ... 599.00	15.6.2
Speed Sensor 1				
490	Operation mode	-	Selection	11.4.1
491	Division marks	-	1 ... 8192	11.4.2
Repetition frequency input				
496	Operation mode	-	Selection	15.11
497	Divider	-	1 ... 8192	15.11
Logic Modules				
503	Operation mode Logic 4	-	Selection	16.5.3
504	Input 1 Logic 4	-	Selection	16.5.3
505	Input 2 Logic 4	-	Selection	16.5.3
Brake Chopper				
506	Trigger Threshold	V	225 ... 1000.0 (210) 425 ... 1000.0 (410)	19.4
Motor Chopper				
507	Trigger Threshold	V	225 ... 1000.0 (210) 425 ... 1000.0 (410)	19.7.1
Digital Outputs				
510	Setting Frequency	Hz	0.00 ... 599.00	16.3.1
Percentage Value Limits				
518	Minimum Reference Percentage	%	0.00 ... 300.00	15.3
519	Maximum Reference Percentage	%	0.00 ... 300.00	15.3
Fixed Percentages				
520	Fixed Percentage 1	%	-300.00 ... 300.00	15.6.3
521	Fixed Percentage 2	%	-300.00 ... 300.00	15.6.3
522	Fixed Percentage 3	%	-300.00 ... 300.00	15.6.3
523	Fixed Percentage 4	%	-300.00 ... 300.00	15.6.3
Digital Outputs				
530	Op. Mode Digital Output 1	-	Selection	16.3
532	Op. Mode Digital Output 3	-	Selection	16.3
536	Create Warning Mask	-	Selection	16.3.7
540	Op. Mode Comparator 1	-	Selection	16.5.2
541	Comparator On above	%	-300.00 ... 300.00	16.5.2
542	Comparator Off below	%	-300.00 ... 300.00	16.5.2
543	Op. Mode Comparator 2	-	Selection	16.5.2
544	Comparator On above	%	-300.00 ... 300.00	16.5.2
545	Comparator Off below	%	-300.00 ... 300.00	16.5.2
549	Max. Control Deviation	%	0.01 ... 20.00	16.3.2
Multifunctional output 1				
550	Operation mode	-	Selection	16.2
551	Voltage 100%	V	0.0 ... 22.0	16.2.1.1
552	Voltage 0%	V	0.0 ... 24.0	16.2.1.1
553	Analog Operation	-	Selection	16.2.1
554	Digital Operation	-	Selection	16.3
555	Repetition Freq. Operation	-	Selection	16.2.2
556	Division marks	-	30 ... 8192	16.2.2.1
Error/warning behavior				

570	Motor Temp. Operation Mode	-	Selection	14.6
-----	----------------------------	---	-----------	------

Motor Circuit Breaker						
No.	Description	Unit	Setting range	Chapter		
	571	Operation mode	-	Selection	16.2.2	
	572	Frequency Limit	%	0 ... 300	16.2.2.1	
Intelligent current limits						
	573	Operation mode	-	Selection	18.1	
	574	Power Limit	%	40.00 ... 95.00	18.1	
	575	Limitation Time	min	5 ... 300	18.1	
Error/warning behavior						
	576	Phase Supervision	-	Selection	14.7	
	578	Allowed No. of Auto-Acknowl.	-	0 ... 20	14.7	
	579	Restart Delay	ms	0 ... 1000	14.8	
Pulse Width Modulation						
	580	Reduction Limit Heat Sink Temp.	deg.C	-25 ... 0	19.1	
V-belt Monitoring						
	581	Operation mode	-	Selection	19.6	
	582	Trigger Limit Iactive	%	0.1 ... 100.0	19.6	
	583	Delay Time	s	0.1 ... 600.0	19.6	
V/f characteristic						
<input checked="" type="checkbox"/>		600	Starting Voltage	V	0.0 ... 100.0	17
<input checked="" type="checkbox"/>		601	Voltage Rise	%	-100 ... 200	17
<input checked="" type="checkbox"/>		602	Rise Frequency	%	0 ... 100	17
<input checked="" type="checkbox"/>		603	Cut-Off Voltage	V	60.0 ... 560.0	17
<input checked="" type="checkbox"/>		604	Cut-Off Frequency	Hz	0.00 ... 599.00	17
		605	Dyn. Voltage Pre-Control	%	0 ... 200	0
Current limit value controller						
	610	Operation mode	-	Selection	18.4.2	
	611	Amplification	-	0.01 ... 30.00	18.4.2	
	612	Integral Time	ms	1 10000	18.4.2	
	613	Current Limit	A	0.0 ... 0 · I _{FIN}	18.4.2	
<input checked="" type="checkbox"/>		614	Frequency Limit	Hz	0.00 ... 599.00	18.4.2
Starting Behavior						
<input checked="" type="checkbox"/>		620	Operation mode	-	Selection	13.1.1
		621	Amplification	-	0.01 ... 10.00	13.1.1
		622	Integral Time	ms	1 ... 30000	13.1.1
<input checked="" type="checkbox"/>		623	Starting Current	A	0.0 ... 0 · I _{FIN}	13.1.1.1
<input checked="" type="checkbox"/>		624	Frequency Limit	Hz	0.00 ... 100.00	13.1.1.2
Stopping Behavior						
	630	Operation mode	-	Selection	13.2	
Direct current brake						
<input checked="" type="checkbox"/>		631	Braking Current	A	0.00 ... $\sqrt{2} \cdot I_{FIN}$	13.3
		632	Braking Time	s	0.0 ... 200.0	13.3
<input checked="" type="checkbox"/>		633	Demagnetizing Time	s	0.1 ... 30.0	13.3
		634	Amplification	-	0.00 ... 10.00	13.3
		635	Integral Time	ms	0 ... 1000	13.3
Stopping Behavior						
	637	Switch-Off Threshold	%	0.0 ... 100.0	13.2.1	
	638	Holding Time	s	0.0 ... 200.0	13.2.2	

Search Run					
No.	Description	Unit	Setting range	Chapter	
	645 Operation mode	-	Selection	13.5	
	646 Brak. Time after Search Run	s	0.0 ... 200.0	13.5	
	647 Current / Rated Motor Current	%	1.00 ... 100.00	13.5	
	648 Amplification	-	0.00 ... 10.00	13.5	
	649 Integral Time	ms	0 ... 1000	13.5	
Auto Start					
	651 Operation mode	-	Selection	13.4	
Slip compensation					
<input checked="" type="checkbox"/>		660 Operation mode	-	Selection	18.4.1
	661 Amplification	%	0.0 ... 300.0	18.4.1	
	662 Max. Slip Ramp	Hz/s	0.01 ... 650.00	18.4.1	
	663 Minimum Frequency	Hz	0.01 ... 599.00	18.4.1	
Voltage controller					
	670 Operation mode	-	Selection	18.2	
	671 Mains Failure Threshold	V	-200.0 ... -50.0	18.2	
	672 Reference Mains Support Value	V	-200.0 ... -10.0	18.2	
	673 Mains Support Deceleration	Hz/s	0.01 ... 9999.99	18.2	
	674 Acceleration on Mains Resumption	Hz/s	0.00 ... 9999.99	18.2	
	675 Shutdown Threshold	Hz	0.00 ... 599.00	18.2	
	676 Reference Shutdown Value	V	225 ... 387.5 (210) 425 ... 775 (410)	18.2	
	677 Amplification	-	0.00 ... 30.00	18.2	
	678 Integral Time	ms	0 ... 10000	18.2	
	680 Reference DC-Link Limitation	V	225 ... 387,5 (210) 425 ... 775 (410)	18.2	
	681 Max. Frequency Rise	Hz	0.00 ... 599.00	18.2	
	683 Gen. Ref. Current Limit	A	0.0 ... 0 · I _{FIN}	18.2	
Current Controller					
<input checked="" type="checkbox"/>		700 Amplification	-	0.00 ... 2.00	18.5.1
<input checked="" type="checkbox"/>		701 Integral Time	ms	0.00 ... 10.00	18.5.1
Further motor parameters					
<input checked="" type="checkbox"/>		713 Magnetizing Current 50% Flux	%	1 ... 50	11.2.3
<input checked="" type="checkbox"/>		714 Magnetizing Current 80% Flux	%	1 ... 80	11.2.3
<input checked="" type="checkbox"/>		715 Magnetizing Current 110% Flux	%	110 ... 197	11.2.3
<input checked="" type="checkbox"/>		716 Rated Magnetizing Current	A	0.01·I _{FIN} ... 0·I _{FIN}	11.2.3
Field Controller					
<input checked="" type="checkbox"/>		717 Reference Flux	%	0.01 ... 300.00	18.5.5
Further motor parameters					
<input checked="" type="checkbox"/>		718 Rated Slip Correction Factor	%	0.01 ... 300.00	11.2.4
Frequency Limits					
	719 Slip Frequency	%	0 ... 10000	15.1	
Speed controller					
	720 Operation mode	-	Selection	18.5.3	
<input checked="" type="checkbox"/>		721 Amplification 1	-	0.00 ... 200.00	18.5.3
	722 Integral Time 1	ms	0 ... 60000	18.5.3	
<input checked="" type="checkbox"/>		723 Amplification 2	-	0.00 ... 200.00	18.5.3
	724 Integral Time 2	ms	0 ... 60000	18.5.3	
Acceleration Pre-Control					
	725 Operation mode	-	Selection	18.5.4	
	726 Minimum Acceleration	Hz/s	0.1 ... 6500.0	18.5.4	

	727	Mech. Time Constant	ms	1 ... 60000	18.5.4
Speed controller					
	No.	Description	Unit	Setting range	Chapter
	728	Current Limit	A	0.0 ... 0 · I _{FIN}	18.5.3.1
	729	Current Limit Generator Operation	A	-0.1 ... 0 · I _{FIN}	18.5.3.1
	730	Torque Limit	%	0.00 ... 650.00	18.5.3.1
	731	Torque Limit Generator Operation	%	0.00 ... 650.00	18.5.3.1
	732	P-Comp. Torque Upper Limit	%	0.00 ... 650.00	18.5.3.1
	733	P-Comp. Torque Lower Limit	%	0.00 ... 650.00	18.5.3.1
Speed controller					
	734	Isq Limit Source Motor Operation	-	Selection	18.5.3.2
	735	Isq Limit Source Generator Op.	-	Selection	18.5.3.2
	736	Torque Limit Source Motor Op.	-	Selection	18.5.3.2
	737	Torque Limit Source Gen. Op.	-	Selection	18.5.3.2
<input checked="" type="checkbox"/> 	738	Speed Control Switch-Over Limit	Hz	0.00 ... 599.00	18.5.3
	739	Power Limit	kW	0.00 ... 2·0·P _{FIN}	18.5.3.1
	740	Power Limit Generator Operation	kW	0.00 ... 2·0·P _{FIN}	18.5.3.1
Field Controller					
	741	Amplification	-	0.0 ... 100.0	18.5.5
<input checked="" type="checkbox"/> 	742	Integral Time	ms	0.0 ... 1000.0	18.5.5
<input checked="" type="checkbox"/> 	743	Ref. Isd Upper Limit	A	0.1·I _{FIN} ... 0·I _{FIN}	18.5.5.1
<input checked="" type="checkbox"/> 	744	Ref. Isd Lower Limit	A	-I _{FIN} ... I _{FIN}	18.5.5.1
Speed controller					
	748	Backlash Damping	%	0 ... 300	18.5.3
Modulation Controller					
	750	Reference Modulation	%	3.00 ... 105.00	18.5.6
	752	Integral Time	ms	0.0 ... 1000.00	18.5.6
	753	Operation mode	-	Selection	18.5.6
	755	Reference Imr Lower Limit	A	0.01·I _{FIN} ... 0·I _{FIN}	18.5.6.1
	756	Control Deviation Limitation	%	0.00 ... 100.00	18.5.6.1
Encoder Monitoring					
	760	Operation mode	-	Selection	19.7.3
	761	Timeout: Signal Fault	ms	0 ... 65000	19.7.3
	762	Timeout: Channel fault	ms	0 ... 65000	19.7.3
	763	Timeout: Direction fault	ms	0 ... 65000	19.7.3
Torque Controller					
	767	Frequency Upper Limit	Hz	-599.00 ... 599.00	18.5.2
	768	Frequency Lower Limit	Hz	-599.00 ... 599.00	18.5.2
	769	Frequency Upper Limit Source	-	Selection	18.5.2.1
	770	Frequency Lower Limit Source	-	Selection	18.5.2.1
Starting Behavior					
<input checked="" type="checkbox"/> 	780	Max. Flux-Formation Time	ms	1 ... 10000	13.1.2
<input checked="" type="checkbox"/> 	781	Current during Flux Formation	A	0.1·I _{FIN} ... 0·I _{FIN}	13.1.2
Timer					
	790	Operation Mode Timer 1	-	Selection	16.5.1
	791	Time 1 Timer 1	s/m/h	0 ... 650.00	16.5.1
	792	Time 2 Timer 1	s/m/h	0 ... 650.00	16.5.1
	793	Operation Mode Timer 2	-	Selection	16.5.1
	794	Time 1 Timer 2	s/m/h	0 ... 650.00	16.5.1
	795	Time 2 Timer 2	s/m/h	0 ... 650.00	16.5.1
Self-configuration					

796	SETUP Select	-	Selection	9.5
-----	--------------	---	-----------	-----

AUSTRALIA

Bonfiglioli Transmission (Aust.) Pty Ltd

2, Cox Place Glendenning NSW 2761
Locked Bag 1000 Plumpton NSW 2761
Tel. +61 2 8811 8000



BRAZIL

Bonfiglioli Redutores do Brasil Ltda

Travessa Cláudio Armando 171 - Bloco 3
CEP 09861-730 - Bairro Assunção
São Bernardo do Campo - São Paulo
Tel. +55 11 4344 2322



CHINA

Bonfiglioli Drives (Shanghai) Co. Ltd.

#68, Hui-Lian Road, QingPu District,
201707 Shanghai
Tel. +86 21 6700 2000



#568, Longpan Road, Jiading District,
201707 Shanghai



Bonfiglioli Trading (Shanghai) Co. Ltd.

Room 423, 4th Floor, #38, Yinglun Road,
China (Shanghai) Pilot Free Trade Zone,
Shanghai



FRANCE

Bonfiglioli Transmission s.a.

14 Rue Eugène Pottier
Zone Industrielle de Moimont II
95670 Marly la Ville
Tel. +33 1 34474510



GERMANY

Bonfiglioli Deutschland GmbH

Sperberweg 12 - 41468 Neuss
Tel. +49 0 2131 2988 0



Bonfiglioli Vectron GmbH

Europark Fichtenhain B6 - 47807 Krefeld
Tel. +49 0 2151 8396 0



O&K Antriebstechnik GmbH

Ruhrallee 8-12 - 45525 Hattingen
Tel. +49 0 2324 2050 1



INDIA

Bonfiglioli Transmission Pvt. Ltd.

Mobility & Wind Industries
AC 7 - AC 11 Sidco Industrial Estate
Thirumudivakkam Chennai - 600 044
Tel. +91 844 844 8649



Discrete Manufacturing & Process Industries - Motion & Robotics

Survey No. 528/1,
Perambakkam High Road Mannur
Village,
Sriperumbudur Taluk Chennai - 602 105
Tel. +91 844 844 8649



Discrete Manufacturing & Process Industries

Plot No.A-9/5, Phase IV MIDC Chakan,
Village Nighoje Pune - 410 501
Tel. +91 844 844 8649



ITALY

Bonfiglioli Riduttori S.p.A.

Discrete Manufacturing & Process Industries
Via Cav. Clementino Bonfiglioli, 1
40012 Calderara di Reno
Tel. +39 051 6473111



Discrete Manufacturing & Process Industries

Via Sandro Pertini, lotto 7b
20080 Carpiano
Tel. +39 02985081



Discrete Manufacturing & Process Industries

Via Saliceto, 15 - 40010 Bentivoglio



Mobility & Wind Industries

Via Enrico Mattei, 12 Z.I. Villa Selva
47122 Forlì
Tel. +39 0543 789111



Motion & Robotics

Via Unione, 49 - 38068 Rovereto
Tel. +39 0464 443435/36



NEW ZEALAND

Bonfiglioli Transmission (Aust.) Pty Ltd

88 Hastie Avenue, Mangere Bridge,
2022 Auckland
PO Box 11795, Ellerslie
Tel. +64 09 634 6441



SINGAPORE

Bonfiglioli South East Asia Pte Ltd

8 Boon Lay Way, #04-09,
8@ Tadehub 21, Singapore 609964
Tel. +65 6268 9869



SLOVAKIA

Bonfiglioli Slovakia s.r.o.

Robotnícka 2129
Považská Bystrica, 01701 Slovakia
Tel. +421 42 430 75 64



SOUTH AFRICA

Bonfiglioli South Africa Pty Ltd.

55 Galaxy Avenue, Linbro Business Park,
Sandton, Johannesburg
2090 South Africa
Tel. +27 11 608 2030



SPAIN

Tecnotrans Bonfiglioli S.A

Pol. Ind. Zona Franca, Sector C,
Calle F, nº 6 - 08040 Barcelona
Tel. +34 93 447 84 00



TURKEY

Bonfiglioli Turkey Jsc

Atatürk Organize Sanayi Bölgesi,
10007 Sk. No. 30
Atatürk Organize Sanayi Bölgesi,
35620 Çiğli - Izmir
Tel. +90 0 232 328 22 77



UNITED KINGDOM

Bonfiglioli UK Ltd.

Unit 1 Calver Quay, Calver Road, Winwick
Warrington, Cheshire - WA2 8UD
Tel. +44 1925 852667



USA

Bonfiglioli USA Inc.

3541 Hargrave Drive
Hebron, Kentucky 41048
Tel. +1 859 334 3333



VIETNAM

Bonfiglioli Vietnam Ltd.

Lot C-9D-CN My Phuoc Industrial Park 3
Ben Cat - Binh Duong Province
Tel. +84 650 3577411



 PRODUCTION

 ASSEMBLY

 SALES

 SERVICE



Abbiamo un'inflessibile dedizione per l'eccellenza, l'innovazione e la sostenibilità. Il nostro Team crea, distribuisce e supporta soluzioni di Trasmissioni e Controllo di Potenza per mantenere il mondo in movimento

We have a relentless commitment to excellence, innovation & sustainability. Our team creates, distributes and services world-class power transmission & drive solutions to keep the world in motion.

Wir verpflichten uns kompromisslos zu Qualität, Innovation und Nachhaltigkeit. Unser Team entwickelt, vertreibt und wartet erstklassige Energieübertragungs- und Antriebslösungen, um die Welt in Bewegung zu halten

Notre engagement envers l'excellence, l'innovation et le développement durable guide notre quotidien. Notre Équipe crée, distribue et entretient des solutions de transmission de puissance et de contrôle du mouvement contribuant ainsi à maintenir le monde en mouvement.

Tenemos un firme compromiso con la excelencia, la innovación y la sostenibilidad. Nuestro equipo crea, distribuye y da soporte en soluciones de transmisión y control de potencia para que el mundo siga en movimiento.

COD. VEC1201 R1

HEADQUARTERS
Bonfiglioli S.p.A
Registered Office: Via Bazzane, 33
40012 Calderara di Reno BO
Head office: Via Isonzo, 65/67/69
40033 Casalecchio di Reno BO
ITALY

tel: +39 051647 3111
www.bonfiglioli.com